

CECW-EG  Engineer Manual 1110-1-1802	Department of the Army U.S. Army Corps of Engineers Washington, DC 20314-1000	EM 1110-1-1802  31 August 1995
	Engineering and Design  GEOPHYSICAL EXPLORATION FOR ENGINEERING AND ENVIRONMENTAL INVESTIGATIONS	
	<b>Distribution Restriction Statement</b> Approved for public release; distribution is unlimited.	

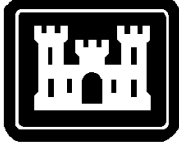

EM 1110-1-1802  
31 August 1995

**US Army Corps  
of Engineers**

**ENGINEERING AND DESIGN**

---

# **Geophysical Exploration for Engineering and Environmental Investigations**

**ENGINEER MANUAL**

### **AVAILABILITY**

Copies of this and other U.S. Army Corps of Engineers publications are available from National Technical Information Service, 5285 Port Royal Road, Springfield, VA 22161. Phone (703)487-4650.

Government agencies can order directly from the U.S. Army Corps of Engineers Publications Depot, 2803 52nd Avenue, Hyattsville, MD 20781-1102. Phone (301)436-2065. U.S. Army Corps of Engineers personnel should use Engineer Form 0-1687.

### **UPDATES**

For a list of all U.S. Army Corps of Engineers publications and their most recent publication dates, refer to Engineer Pamphlet 25-1-1, Index of Publications, Forms and Reports.

DEPARTMENT OF THE ARMY  
U.S. Army Corps of Engineers  
Washington, DC 20314-1000

EM 1110-1-1802

CECW-EG

Manual  
No. 1110-1-1802

31 August 1995

**Engineering and Design  
GEOPHYSICAL EXPLORATION FOR ENGINEERING  
AND ENVIRONMENTAL INVESTIGATIONS**

**1. Purpose.** This manual provides an introduction to geophysical exploration for engineering, geological, and environmental (to include Hazardous, Toxic and Radioactive Waste (HTRW)) investigations. Descriptions and guidance are provided for the geophysical methods typically used in these investigations.

**2. Applicability.** This manual applies to HQUSACE elements, major subordinate commands, districts, laboratories, and field operating activities having responsibilities for civil works and/or military programs.

FOR THE COMMANDER:



ROBERT H. GRIFFIN  
Colonel, Corps of Engineers  
Chief of Staff

CECW-EG

Manual  
 No. 1110-1-1802

31 August 1995

**Engineering and Design  
 GEOPHYSICAL EXPLORATION FOR ENGINEERING  
 AND ENVIRONMENTAL INVESTIGATIONS**

**Table of Contents**

<b>Subject</b>	<b>Paragraph</b>	<b>Page</b>	<b>Subject</b>	<b>Paragraph</b>	<b>Page</b>
<b>Chapter 1</b>			Induced Polarization . . . . . 4-5 4-24		
<b>Introduction</b>			Time-Domain Electromagnetic		
Purpose . . . . .	1-1	1-1	Techniques for Resistivity		
Applicability . . . . .	1-2	1-1	Sounding . . . . .	4-6	4-30
References . . . . .	1-3	1-1	Frequency-Domain Electro-		
Worker and Environmental Safety . .	1-4	1-1	magnetic Methods . . . . .	4-7	4-40
Glossary . . . . .	1-5	1-1	Terrain Conductivity . . . . .	4-8	4-42
Proponent . . . . .	1-6	1-1	Metal Detector Surveys . . . . .	4-9	4-47
<b>Chapter 2</b>			Ground-Penetrating Radar . . . . .	4-10	4-51
<b>Geophysical Methodology</b>			Very Low-Frequency EM		
Uses of Geophysical Surveys . . . . .	2-1	2-1	Procedures . . . . .	4-11	4-55
Responsibilities of the Project			<b>Chapter 5</b>		
Team . . . . .	2-2	2-5	<b>Gravity Techniques</b>		
<b>Chapter 3</b>			Introduction . . . . .	5-1	5-1
<b>Seismic Procedures</b>			Applications . . . . .	5-2	5-1
General Seismic Methods . . . . .	3-1	3-1	Noise Evaluation . . . . .	5-3	5-2
Seismic Refraction . . . . .	3-2	3-4	Rock Properties . . . . .	5-4	5-3
Shallow Seismic Reflection . . . . .	3-3	3-19	Field Work . . . . .	5-5	5-4
Surface Wave Methods . . . . .	3-4	3-23	<b>Chapter 6</b>		
Subbottom Profiling . . . . .	3-5	3-26	<b>Magnetic Methods</b>		
<b>Chapter 4</b>			Introduction . . . . .	6-1	6-1
<b>Electrical and Electromagnetic</b>			Theory . . . . .	6-2	6-1
<b>Methods</b>			Field Work . . . . .	6-3	6-2
Introduction . . . . .	4-1	4-1	<b>Chapter 7</b>		
Self-Potential Method . . . . .	4-2	4-3	<b>Subsurface Geophysical</b>		
Equipotential and			<b>Methods</b>		
Mise-a-la-Masse Methods . . . . .	4-3	4-6	General In-hole Logging		
Resistivity Methods . . . . .	4-4	4-8	Procedures . . . . .	7-1	7-1

Subject	Paragraph	Page
General Crosshole Procedures . . . . .	7-2	7-50
Surface to Borehole Procedures . . . . .	7-3	7-60

**Chapter 8**

**Airborne Geophysical Methods**

Scope of Airborne Investigations . . . . .	8-1	8-1
Airborne Geophysical Measures . . . . .	8-2	8-1
Contracting . . . . .	8-3	8-2

**Chapter 9**

**Remote Sensing**

Introduction . . . . .	9-1	9-1
Capabilities of Remote Sensor . . . . .	9-2	9-1
Characteristics of Various Remote Sensor Data . . . . .	9-3	9-3
Sources and Characteristics of Available and Historic Data . . . . .	9-4	9-7
Data Set Procurement and Merging . . . . .	9-5	9-9

Subject	Paragraph	Page
Presentation of Data . . . . .	9-6	9-11
Remote Sensing Recommendations . . . . .	9-7	9-11

**Chapter 10**

**Engineering Vibration  
Investigations**

Earthquake-Resistant Design . . . . .	10-1	10-1
Vibration Concerns . . . . .	10-2	10-1
Acoustic Emissions . . . . .	10-3	10-2
Nondestructive Testing . . . . .	10-4	10-3

**Appendix A  
References**

**Appendix B  
Glossary**

## Chapter 1 Introduction

### 1-1. Purpose

This manual provides an introduction to geophysical exploration for engineering, geological, and environmental (to include Hazardous, Toxic and Radioactive Waste) investigations. Descriptions and guidance are provided for geophysical methods typically used in these investigations. The manual furnishes a broad overview of geophysical applications to common engineering, environmental and geological problems. Descriptions of the most commonly conducted geophysical procedures are given. These contents are not proposed to explicitly develop field procedures and data reduction techniques for geophysical surveys. Chapter 2 develops the procedural evaluation, use, and deployment of the generalized geophysical approach. Subsequent chapters address particular geophysical methodologies.

### 1-2. Applicability

This manual applies to Headquarters, U.S. Army Corps of Engineers elements, major subordinate commands, districts, laboratories, and field operating activities having responsibilities for civil works and/or military programs.

### 1-3. References

References are listed in Appendix A.

### 1-4. Worker and Environmental Safety

This manual does not purport to address the safety risks associated with geophysical exploration. Geophysical

surveys have their own associated hazards, particularly with active energy sources. Some active sources are: shallow explosions for seismic methods; applied electrical current with resistivity methods; and, pulsed electromagnetic fields for ground-penetrating radar. These hazards are addressed regularly by the geophysical survey crew during planning and field deployment. The addition of environmental site hazards (such as unexploded ordnance) may compound the risks of geophysical exploration. Every instance of compounded hazard cannot be uniquely addressed in this manual. Geophysical personnel and the survey customer must have a continuous dialogue and flexible plan to consider and accommodate the aspects of environmental hazards. In addition, that plan should incorporate health and safety practices in accordance with applicable regulations and expert guidance.

### 1-5. Glossary

Appendix B is a list of terms used in seismic processing and well-logging.

### 1-6. Proponent

The U.S. Army Corps of Engineers' proponent for this manual is the Geotechnical and Materials Branch, Engineering Division, Directorate of Civil Works (CECW-EG). Any comments or questions regarding the content of this Engineer Manual should be directed to the proponent at the following address.

Headquarters, U.S. Army Corps of Engineers  
Attn: CECW-EG  
20 Massachusetts Ave., NW  
Washington, DC 20314-1000

## Chapter 2 Geophysical Methodology

### 2-1. Uses of Geophysical Surveys

#### *a. Objectives.*

(1) Three classes of objectives are addressed by geophysical surveys: the measurement of geologic features, the in situ determination of engineering properties, and the detection of hidden cultural features. Geologic features may include faults, bedrock lows, discontinuities and voids, and groundwater. Engineering properties that can be determined in situ include elastic moduli, electrical resistivity and, to a lesser degree, magnetic and density properties. Hidden cultural features available for geophysical detection and characterization include buried underground tanks and pipes, contaminant plumes, and landfill boundaries.

(2) Applied geophysics can contribute to the solution of most geotechnical engineering and environmental problems. The geophysical technique does not often directly measure the parameter needed to solve the problem under consideration. Each geophysical procedure measures a contrast. A few problems of interest in engineering may be developed directly from the measured contrast, i.e. finding the resistivity for design of a grounding mat of an electrical power grid. The vast majority of objectives are inferred from the known geologic data and the measured geophysical contrast. Some surveyed contrasts that provide indirect hypotheses are:

(a) Media velocities from seismic methods to determine the top of rock.

(b) Streaming potentials from the self-potential technique to locate a flowing reservoir conduit in a dam abutment.

(c) High conductivities measured with a terrain conductivity meter to locate an inorganic plume on the groundwater surface.

(d) High apparent conductivity assessed with a metal detector which infers a large metallic cache of possibly buried drums.

(e) Low density contrast measured with a gravimeter due to a suspected abandoned shallow coal mine.

*b. General observations.* Several general observations should be kept in mind when considering applications of geophysical methods.

(1) Resolution, that is the ability of the geophysical measurements to differentiate between two similar geologic situations, varies widely between geophysical methods. Resolution is a function of time and effort expended and may be improved up to a limit, usually far in excess of the resources available to conduct the study. Ambiguity usually indicates a practical limit on geophysical results before the lack of resolution becomes a factor.

(2) Most geophysical methods do not directly measure the parameter desired by the project manager, geologist or engineer. Resistivity and acoustic bursts (for acoustic emissions) are exceptions. The correlation of measured geophysical contrasts with geologic inferences most often is empirical and certainly is dependent on the quality of both the results and the hypotheses. Usually an inverse solution is determined in geophysical exploration. Inversion implies that a cause was inferred from an effect. The physical property, the cause, is inferred from the field survey readings, the effects. Inverse resolutions are not unique conclusions, and provide a most likely solution selected from numerous possibilities. Forward solutions proceed from cause to effect and are unique determinations. Forward analyses are often preliminary evaluations to predict amplitudes and relations from possible physical conditions. Forward solutions may be used subsequent to field surveys to assess hypothesis variants among geologic alternatives.

(3) The interpretation of geophysical contrasts is based on geologic assumptions. Ambiguity is inherent in the geophysical interpretation process. Preparation of geophysical models almost always assumes the following:

(a) Earth materials have distinct subsurface boundaries.

(b) A material is homogeneous (having the same properties throughout).

(c) The unit is isotropic (properties are independent of direction).

These assumptions are, in many cases, at variance with the reality of geologic occurrences. Units may grade from one material type to another with no distinct surface between two materials. At some scale, inhomogeneities



exist in practically all units. Properties may occasionally vary greatly in magnitude with direction, such as in shales. Ambiguity, however, can be summarized as an equivalence of geometry/size and a material's properties. Structure may be reevaluated by changing physical parameters. Ambiguity applies to all geophysical methods, and is most conveniently resolved by understanding geologic reality in the interpretation. The extent to which these presumptions are valid or the magnitude that the assumptions are in error will have a direct bearing on the conclusions.

(4) It is important to differentiate between accuracy and precision in geophysical results. Geophysical measurements are very precise. The measurements can be repeated to a remarkable degree on another day, even by another field crew. If accuracy is evaluated as the convergence of the geophysical interpretation with measured geologic data, then geophysical results are not particularly accurate by themselves. However, when appropriate subsurface investigations are integrated with geophysical measurements, large volumes of material can be explored both accurately and cost-effectively.

(5) There is no substitute for specific geologic or engineering observations (such as borings, test pits, trenches, geophysical well logging, and cross-hole tests), because of the empirical correlation between results and the inferred objective solution. These borings or other tests are used to validate and calibrate the geophysical results, and ultimately to improve the accuracy of the integrated conclusions. Except where accuracy considerations are not important, some form of external calibration of the empirical geophysical assumptions is required.

(6) Interpretation is a continuous process throughout geophysical investigations. The adequacy of the field data to achieve the project objectives is interpreted on the spot by the field geophysicists. Data processing, the steps of preparing the field data for geophysical interpretation, often includes judgements and observations based on the experience of the processor. Implementation of a geophysical model, which satisfactorily accounts for the geophysical observations, fits only the narrowest definition of interpretation. Correlation of the geophysical model with available ground truth can be a laborious interpretative process, especially since iterations of both the geophysical models and the geologic model are usually required. Production of the final product in a form useful to the customer (engineer or geologist) is the most necessary interpretative step.

(7) Applied geophysics is only one step in a phased, sequential approach in performing a geologically based task. Any goal requires basic data, a problem statement, investigation of the problem and solution development. Problems in geological, geotechnical or environmental projects require some basic geological information prior to use of geophysical techniques. The determined geophysical contrasts are evaluated and a solution inferred for the likely environment. This hypothesis itself may require geologic assessment with borings or other field exploration. The planning of the phased, sequential solution will provide the best solution at the lowest cost.

*c. Geophysical methods.* Geophysical methods can be classified as active or passive techniques. Active techniques impart some energy or effect into the earth and measure the earth materials' response. Passive measurements record the strengths of various natural fields which are continuous in existence. Active techniques generally produce more accurate results or more detailed solutions due to the ability to control the size and location of the active source.

(1) There are scores of geophysical techniques which have demonstrated commercial success. In addition, innumerable variations of well-known techniques have been applied in special cases. This manual cites many surface, subsurface, and airborne geophysical methods. The included procedures have been utilized most often or have significant applicability to engineering, environmental, and geologic problems.

(a) Classified by physical effect measured, the following surficial techniques are considered herein:

- Seismic (sonic) methods, Chapter 3.
- Electrical and electromagnetic procedures, Chapter 4, with natural electrical fields (self-potential), resistivity (AC and DC fields), and dielectric constant (radar) theory.
- Gravitational field techniques, Chapter 5.
- Magnetic field methods, Chapter 6.

(b) Geophysical measures can also be applied in the subsurface (Chapter 7) and above the earth's surface (Chapters 8 and 9). Down-hole application of geophysics provides in situ measurements adjacent to the borehole or across the medium to the surface. Subsurface applied

geophysics gains detailed insight into the adjoining earth materials. Airborne geophysics is usually not as detailed as surface procedures but offers the distinct advantages of rapid coverage without surface contact.

(c) Vibration theory is considered in Chapter 10. Consideration of earthquake problems, blasting and machine foundations, acoustic emission theory, and non-destructive testing are sections of Chapter 10. These topics are unified under vibration theory, but are accomplished by differing program approaches.

(2) The number of geologic issues considered are limited to the problems most commonly encountered in an engineering or environmental context, since the number of geologic problems is vastly larger than the number of geophysical methods. The accompanying matrix of Table 2-1 displays the cited methods versus the problem types, and evaluates the applicability of the method. One cannot rely blindly on the applicability of this table, because geology is the most important ingredient of the selection of method. This matrix will suggest potential geophysical techniques for particular needs. Geologic input, rock property estimates, modeling, interference effects, and budgetary constraints are co-determining factors of method selection. In an attempt to reduce the impact of geology, the evaluation assumes that a moderate degree of geologic knowledge is known before the matrix is consulted.

*d. Contracting considerations.* Most geophysical work is done by geophysical contractors. Even in-house work is usually done by specialists and the following discussion applies to internal, as well as external, contracting.

(1) The most important part of the contracting process is the preparation of a set of written objectives. The primary pitfall is the tendency of geophysicists to focus on what can be measured, and not on the needs of the customer. If siting monitoring wells on bedrock lows is the objective, detailed bedrock lithology is probably unimportant. The action of writing down the explicit desired final results will often radically change the approach to the problem.

(2) The scope of work also requires a common understanding between contractor and purchaser. However, undue restrictions in the scope of work may prevent an alteration of parameters, quantities, techniques, or methods. Such alterations are common on geophysical

projects. Because of the close cooperation required between the customer and the producer, daily reports (including preliminary results) are almost always required.

(3) Less important, but critical factors subject to negotiation, are: standby time, inclement weather payments, contents of field reports, liability, terms of payment, rights-of entry, responsibility for locating underground utilities, deadlines, and rates. Geophysical daily rates are usually straightforward. The productivity of field crews, however, is dependent on some or all of the following factors: terrain, vegetation, hazardous waste, insects and other biohazards, weather (particularly season), logistics, commute time or access to the field location, third-party observers, experience and resourcefulness of field crew, and interference with geophysical measurements (noise, often related to industrial or urban location).

(4) The geophysicist(s) must have access to all relevant information concerning the site. This data includes: site geology, site maps, boring logs, sources and contaminant types that are known or presumed, hazards and safety conditions impacting field work, etc. The development of field work and the hypotheses from the processed geophysical material depend upon validation of the known conditions. Field safety and hazard avoidance may only occur when the field crew has knowledge of all field conditions. Significant liability reverts to the government when all known information is not shared with the geophysical crew.

(5) A site visit is recommended and should be undertaken by an experienced estimator of geophysical costs. Many geophysical contracts are let on a line-mile, per-station, or lump-sum basis. However, if the common objective is neither the bankruptcy of the contractor nor the overcharging of the customer, usually a method can be found to "share the misery" on difficult projects. There is no substitute for experience and trust to supplement written documents purporting to cover all eventualities.

(6) A field-release clause may be a useful vehicle for both the customer and the geophysical contractor. This clause allows contract termination, if the contractor's ability to assess the objective after a short field evaluation is unlikely. Careful scrutiny of the field results near a ground truth area allows the contract to be site-justified, the objective revised, or the contract to be ended. The contract is modified by the consequences of the field-release evaluation.

**Table 2-1  
Decision Matrix of Surficial Geophysical Methods for Specific Investigations**

	Lithology	Top of Bedrock	Rippability	Detection of Water Surface	Fault Detection	Suspected Voids or Cavity Detection	In Situ Elastic Moduli (Velocities)	Material Boundaries, Dip, ...	Linear Subsurface Water Conduits	Landfill Boundaries	Large Ferrous Bodies-Tanks	Conductive Bodies, Ores, Plumes, ...
Seismic Refraction	S	W	W	S	S		W	S				
Seismic Reflection	S	S	S		S	S		W				
SP									W			S
DC Resistivity	S	S		S	S	S		S		W	S	S
Electro-Magnetics					S			S	W	S	S	W
Ground Penetrating Radar		S		S	S	S		S	S	S	S	
Gravity					S	S		S				
Magnetics					S					W	W	

W - works well in most materials and natural configurations.  
S - works under special circumstances of favorable materials or configurations.  
Blank - not recommended.

(7) Effectively written contracts provide the clear objective of the geophysical work and the minimum reporting requirements.

## 2-2. Responsibilities of the Project Team

The objective of any investigation is maintained by exchange of information between the customer and the geophysical contractor. The customer directs the inquiry, but is rarely a specialist in the application of particular procedures.

*a. Interdisciplinary team.* Geophysical exploration is a highly specialized field. Few geophysicists are equally adept at all facets of geophysics. The project manager, the technical specialist (usually an engineer or geologist), and the geophysicist(s) form an interdisciplinary team to meet the objective.

*b. Stated objective.* The project manager is required to have a known and written objective. The technical specialist correlates the site information and identifies tasks to be completed to reach project goals. Engineering

and geologic requirements are evaluated by the specialist and the role of geophysics in satisfying those requirements in detail. A phased approach including preliminary geologic investigations, geophysical contracting, and final engineering evaluation is developed. The geophysical contractor accomplishes the objective established by the manager, as developed from phased site information directed by the specialist.

*c. Geophysical sequence.* The geophysical exploration should be considered early in the development of site characterization. Monetary and time efficiency will be greatest when the geophysical surveys are part of a phased program, especially at large and/or geologically complex sites. Early geophysical exploration allows some subsequent geologic, engineering, or environmental verification. Problems studied late in the field assessment may have little funding for their resolution remaining in budgets to perform necessary work. Further, there will be little advantage from geophysics performed late in exploration programs, as compared to early geophysical application where subsequent investigations may be revised in location and detail.

## Chapter 3 Seismic Procedures

### 3-1. General Seismic Methods

Seismic methods are the most commonly conducted geophysical surveys for engineering investigations. Most students of geophysics learn the analogies of optical laws to seismic wave propagation. Seismic refraction provides engineers and geologists with the most basic of geologic data via simple procedures with common equipment.

*a. Seismic waves.* Any mechanical vibration sensed by personal perception is initiated from a source and travels to the location where the vibration is noted. The vibration is merely a change in the stress state due to some input disturbance. The vibration emanates in all directions that support displacement. The vibration readily passes from one medium to another, and from solids to liquids or gasses and in reverse. A vacuum cannot support mechanical vibratory waves, while electromagnetic waves transit through a vacuum. The direction of travel is called the ray, ray vector, or raypath. A source produces motion in all directions and the locus of first disturbances will form a spherical shell or wave front in a uniform material. There are two major classes of seismic waves: body waves, which pass through the volume of a material; and, surface waves, that exist only near a boundary.

#### (1) Body waves.

(a) The fastest traveling of all seismic waves is the compressional or pressure or primary wave (P-wave). The particle motion of P-waves is extension (dilation) and compression along the propagating direction. P-waves travel through all media that support seismic waves; air waves or noise in gasses, including the atmosphere, are P-waves. Compressional waves in fluids, e.g. water and air, are commonly referred to as acoustic waves.

(b) The second wave type to reach a point through a body is the secondary or transverse or shear wave (S-wave). S-waves travel slightly slower than P-waves in solids. S-waves have particle motion perpendicular to the propagating direction, like the obvious movement of a rope as a displacement speeds along its length. These transverse waves can only transit material that has shear strength. S-waves do not exist in liquids and gasses, as these media have no shear strength.

(c) S-waves may be produced by a traction source or by conversion of P-waves at boundaries. The dominant particle displacement is vertical for SV-waves traveling in a horizontal plane. Particle displacements are horizontal for SH-waves traveling in the vertical plane. SH-waves are often generated for S-wave refraction evaluations of engineering sites.

(d) Elastic body waves passing through homogeneous, isotropic media have well-defined equations of motion. Most geophysical texts, including Grant and West (1965), include displacement potential and wave equations. Utilizing these equations, computations for the wave speed may be uniquely determined. Field surveys can readily obtain wave velocities,  $V_p$  and  $V_s$ ; velocities are in units of length per time, usually meters/second (m/s). A homogeneous, isotropic medium's engineering properties of Young's or elastic modulus (E) and shear modulus (G) and either density ( $p_b$ ) OR Poisson's ratio ( $\nu$ ) can be determined, if  $V_p$  and  $V_s$  are known. The units of these measures are: moduli in pressure, usually pascals (Pa); density in mass per volume, grams/cubic meter ( $\text{g/m}^3 = 10^{-6} \text{ mg/m}^3$ ); and,  $\nu$ , dimensionless. Manipulation of equations from Grant and West (1965) yields

$$\nu = [(V_p/V_s)^2 - 2] / \{2[(V_p/V_s)^2 - 1]\} \quad (3-1)$$

$$E = p_b V_p^2 (1-2\nu)(1+\nu)/(1-\nu) \quad (3-2)$$

$$G = E/[2(1+\nu)] \quad (3-3)$$

$$p_b = G/V_s^2 \quad (3-4)$$

Note that these are not independent equations. Knowing two velocities uniquely determines only TWO unknowns of  $p_b$ ,  $\nu$ , or  $E$ . Shear modulus is dependent on two other values. Poisson's ratio must be from 0.0 to a value less than 0.5 from Equations 3-1 and 3-2. For units at the surface,  $p_b$  can be determined from samples or for the subsurface from boring samples or downhole logging (see paragraph 7-1k(11)). Estimates may be assumed for  $\nu$  by material type. Usually the possible range of  $p_b$  (also called unit mass) is approximated and  $\nu$  is estimated. Equations 3-1 through 3-4 may be compared to the approximate values with some judgement applied; a similar downhole logging technique is developed in paragraph 7-1k(15)(b). Table 3-1 provides some typical values selected from: Hemen and Hatheway (1992) for  $V_p$ ; Das (1994) for dry  $p_b$  of soils; Blake (1975) for  $p_{b,dry}$  of rock; and Prakash (1981) for  $\nu$ . Other estimates of  $p_b$  are contained in Table 5-1 for gravity methods. Blake (1975)

**Table 3-1**  
**Typical/Representative Field Values of  $V_p$ ,  $\rho_b$ , and  $\nu$  for Various Materials**

Material	$V_p$ (m/s)	$\rho_{b,dry}$ (mg/m <sup>3</sup> )	$\nu$
Air	330		
Damp loam	300-750		
Dry sand	450-900	1.6-2.0	0.3-0.35
Clay	900-1,800	1.3-1.8	-0.5
Fresh, shallow water	1,430-1,490	1.0	
Saturated, loose sand	1,500		
Basal/ lodgement till	1,700-2,300	2.3	
Rock			0.15-0.25
Weathered igneous and metamorphic rock	450-3,700		
Weathered sedimentary rock	600-3,000		
Shale	800-3,700		
Sandstone	2,200-4,000	1.9-2.7	
Metamorphic rock	2,400-6,000		
Unweathered basalt	2,600-4,300	2.2-3.0	
Dolostone and limestone	4,300-6,700	2.5-3.0	
Unweathered granite	4,800-6,700	2.6-3.1	
Steel	6,000		

offers laboratory values of all these parameters, but field values will vary considerably from the lab estimates.

(2) Surface waves. Two recognized disturbances which exist only at “surfaces” or interfaces are Love and Rayleigh waves. Traveling only at the boundary, these waves attenuate rapidly with distance from the surface. Surface waves travel slower than body waves. Love waves travel along the surfaces of layered media, and are most often faster than Rayleigh waves. Love waves have particle displacement similar to SH-waves. Rayleigh waves exhibit vertical and horizontal displacement in the vertical plane of raypath. A point in the path of a Rayleigh wave moves back, down, forward, and up repetitively in an ellipse like ocean waves.

(a) Rayleigh waves are developed by harmonic oscillators, as steady-state motion is achieved around the oscillator’s block foundation. The phase measurement of

the wave allows determination of the wavelengths for differing frequencies of the oscillator. A procedure exists for  $G$  to be computed from these measurements.

(b) Surface waves are produced by surface impacts, explosions and wave form changes at boundaries. Love and Rayleigh waves are also portions of the surface wave train in earthquakes. These surface waves may carry greater energy content than body waves. These wave types arrive last, following the body waves, but can produce larger horizontal displacements in surface structures. Therefore surface waves may cause more damage from earthquake vibrations.

*b. Wave theory.* A seismic disturbance moves away from a source location; the locus of points defining the expanding disturbance is termed the wavefront. At any point on a wavefront, the vibration acts as a new source and causes displacements in surrounding positions. The vector normal to the wavefront is the raypath through that point, and is the direction of propagation.

(1) Upon striking a boundary between differing material properties, wave energy is transmitted, reflected, and converted. The properties of the two media and the angle at which the incident raypath strikes will determine the amount of energy: reflected off the surface, refracted into the adjoining material, lost as heat, and changed to other wave types.

(2) An S-wave in rock approaching a boundary of a lake will have an S-wave reflection, a P-wave reflection, and a likely P-wave refraction into the lake water (depending on the properties and incident angle). Since the rock-water boundary will displace, energy will pass into the lake, but the water cannot support an S-wave. The reflected S-wave departs from the boundary at the same angle normal to the boundary as the arriving S-wave struck.

(3) In the case of a P-wave incident on a boundary between two rock types (of differing elastic properties) there may be little conversion to S-waves. Snell’s Law provides the angles of reflection and refraction for both the P- and S-waves. [Zoeppritz’s equations provide the energy conversion for the body wave forms.] In the rock on the source side (No. 1), the velocities are  $V_{p1}$  and  $V_{s1}$ ; the second rock material (No. 2) has properties of  $V_{p2}$  and  $V_{s2}$ . Then for the incident P-wave ( $P1i$ ), Snell’s Law provides the angles of reflections in rock No. 1 and refraction in rock No. 2 as

$$\begin{aligned} \frac{\sin \alpha_{p1i}}{V_{p1i}} &= \frac{\sin \alpha_{p1}}{V_{p1}} = \frac{\sin \alpha_{s1}}{V_{s1}} \\ &= \frac{\sin \alpha_{p2}}{V_{p2}} = \frac{\sin \alpha_{s2}}{V_{s2}} \end{aligned} \quad (3-5)$$

(a) The second and third terms of Equation 3-5 are reflections within material No. 1; the fourth and fifth terms are refractions into medium No. 2. Note that none of the angles can exceed 90 deg, since none of the sine terms can be over 1.0, and  $\alpha_{p1i} = \alpha_{p1}$ .

(b) Two important considerations develop from understanding Equation 3-5. First is the concept of critical refraction. If rock No. 1 has a lower velocity than rock No. 2 or  $V_{p1} < V_{p2}$ , then from Equation 3-5  $\sin \alpha_{p2} > \sin \alpha_{p1i}$  and the refracted  $\alpha_{p2} > \alpha_{p1i}$ , the incident angle. Yet  $\sin \alpha_{p2}$  cannot exceed 1.00. The critical incident angle causes the refraction to occur right along the boundary at 90 deg from the normal to the surface. The critical angle is that particular incident angle such that  $\sin \alpha_{p2} = 1.0$  and  $\alpha_{p2} = 90$  deg, or  $\alpha_{(p1i)cr} = \sin^{-1}(V_{p1}/V_{p2})$ . Secondly, any incident angle  $> \alpha_{(p1i)cr}$  from the normal will cause total reflection back into the source-side material, since  $\sin \alpha_{p2} \nlessdot 1.0$ . For the latter case, all the P-wave energy will be retained in medium No. 1.

(4) Other wave phenomena occur in the subsurface. Diffractions develop at the end of sharp boundaries. Scattering occurs due to inhomogeneities within the medium. As individual objects shrink in size, their effect on scatter is reduced. Objects with mean dimension smaller than one fourth of the wavelength will have little effect on the wave. Losses of energy or attenuation occur with distance of wave passage. Higher frequency waves lose energy more rapidly than waves of lower frequencies, in general.

(5) The wave travels outward from the source in all directions supporting displacements. Energy dissipation is a function of the distance traveled, as the wave propagates away from the source. At boundaries the disturbance passes into other media. If a wave can pass from a particular point A to another point B, Fermat's principle indicates that the raypath taken is the one taking the minimum amount of time. Stated otherwise, the first arrival between two points occurs on the path of least time. In crossing boundaries of media with different properties, the path will not be the shortest distance (a straight line) due to refractions. The actual raypath will have the shortest travel time. Recall that every point on a wavefront is a

new source; thus, azimuths other than that of the fastest arrival will follow paths to other locations for the ever-expanding wave.

*c. Seismic equipment.* Digital electronics have continued to allow the production of better seismic equipment. Newer equipment is hardier, more productive, and able to store greater amounts of data. The choice of seismograph, sensors called geophones, storage medium, and source of the seismic wave depend on the survey being undertaken. The sophistication of the survey, in part, governs the choice of the equipment and the field crew size necessary to obtain the measurements. Cost rises as more elaborate equipment is used. However, there are efficiencies to be gained in proper choice of source, number of geophone emplacements for each line, crew size, channel capacity of the seismograph, and requirements of the field in terrain type and cultural noise.

#### (1) Sources.

(a) The seismic source may be a hammer repetitively striking an aluminum plate or weighted plank, drop weights of varying sizes, a rifle shot, a harmonic oscillator, waterborne mechanisms, or explosives. The energy disturbance for seismic work is most often called the "shot," an archaic term from petroleum seismic exploration. Reference to the "shot" does not necessarily mean an explosive or rifle source was used. The type of survey dictates some source parameters. Smaller mass, higher frequency sources are preferable. Higher frequencies give shorter wavelengths and more precision in choosing arrivals and estimating depths. Yet sufficient energy needs to be entered to obtain a strong return at the end of the survey line.

(b) The type of source for a particular survey is usually known prior to going into the field. A geophysical contractor normally should be given latitude in selecting or changing the source necessary for the task. The client should not hesitate in placing limits on the contractor's indiscriminate use of some sources. In residential or industrial areas perhaps the maximum explosive charge should be limited. The depth of drilling shot holes for explosives or rifle shots may need to be limited; contractors should be cautious not to exceed requirements of permits, utility easements, and contract agreements.

(2) Geophones. The sensor receiving seismic energy is the geophone (hydrophone in waterborne surveys) or phone. These sensors are either accelerometers or velocity transducers, and convert ground shaking into a voltage response. Typically, the amplification of the ground is

many orders of magnitude, but accomplished on a relative basis. The absolute value of particle acceleration cannot be determined, unless the geophones are calibrated.

(a) Most geophones are vertical, single-axis sensors to receive the incoming wave form from beneath the surface. Some geophones have horizontal-axis response for S-wave or surface wave assessments. Triaxial phones, capable of measuring absolute response, are used in specialized surveys. Geophones are chosen for their frequency band response.

(b) The line, spread, or string of phones may contain one to scores of sensors depending on the type of survey. The individual channel of recording normally will have a single phone. Multiple phones per channel may aid in reducing wind noise or airblast or in amplifying deep reflections.

(c) The type, location and number of phones in the spread is invariably left to the field geophysicists to select, modify and adjust. There is rarely any need for the survey purchaser to be involved with decisions concerning the geophones.

(3) Seismographs.

(a) The equipment that records input geophone voltages in a timed sequence is the seismograph. Current practice uses seismographs that store the channels' signals as digital data in discrete time units. Earlier seismographs would record directly to paper or photographic film. Stacking, inputting, and processing the vast volumes of data and archiving the information for the client virtually require digital seismographs.

(b) The seismograph system may be an elaborate amalgam of equipment to trigger or sense the source, digitize geophone signals, store multichannel data, and provide some level of processing display. Sophisticated seismograph equipment is not normally required for engineering and environmental surveys. One major exception is the equipment for subbottom surveys.

(c) The seismic client will have little to do with selection of the appropriate seismograph. The client should state in the contract an acceptable form of providing the field work data. The submitted field information is usually in an electronic form often with a paper graphic version.

(4) Processing. Data processing of seismic information can be as simple as tabular equations for seismic refraction. Processing is normally the most substantial matter the geophysicists will resolve, except for the interpretation.

(a) The client should not require any particular type of seismic processing. The client normally would be advised to know prior to contracting whether the geophysicists will be using off-the-shelf software or privately developed algorithms. Avoid the use of proprietary processing that is not available to the client.

(b) The processing output and interpretation display is a subject of negotiation. The contract should normally specify the minimum level of performance desired by the client.

### **3-2. Seismic Refraction**

*a. Introduction.* In a homogeneous medium a bundle of seismic energy travels in a straight line. Upon striking a boundary (between two media of differing seismic properties) at an angle, the direction of travel is changed as it is in the refraction of light at the surface of a pond. Seismic refraction uses this change of direction to derive subsurface information. The path of the energy is denoted by arrows or rays in Figure 3-1. The method of seismic refraction consists of the recording of the time of arrival of the first impulses from a shot at a set of detectors distributed on the surface. On Figure 3-1, a particular set of raypaths are of interest. Those raypaths go downward to the boundary and are refracted along the boundary and return to the surface to impact the detectors. The first arrivals near the shot will have paths directly from the shot to the detector. If the lower material has a higher velocity ( $V_2 > V_1$  in Figure 3-1), rays traveling along the boundary will be the first to arrive at receivers away from the shot. If the time of arrival is plotted on a time-distance curve such as Figure 3-2, the rate of change of arrival times between detectors is seen to be proportional to  $V_2$ , the velocity of the lower material beyond the point identified as  $X_c$  in Figure 3-2.

*b. Theory.*

(1) "Crossover distance"  $X_c$  is defined from a plot of the first arrivals versus distance (Figure 3-2) as the point where the slope of the arrival time curve changes. For the idealized case shown, the curve representing the direct



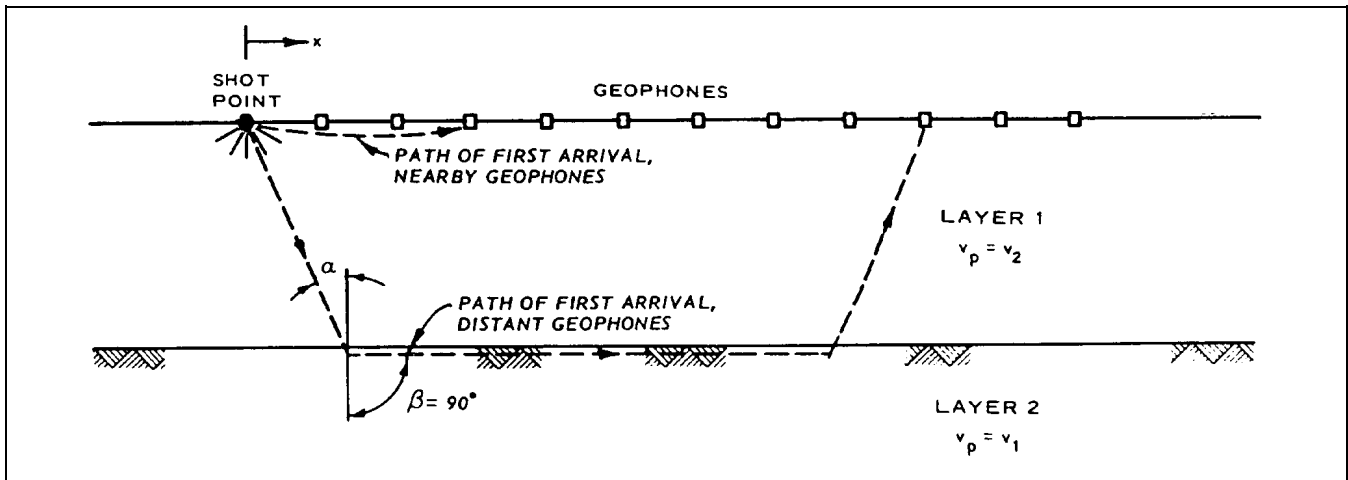

Figure 3-1. Schematic of seismic refraction survey

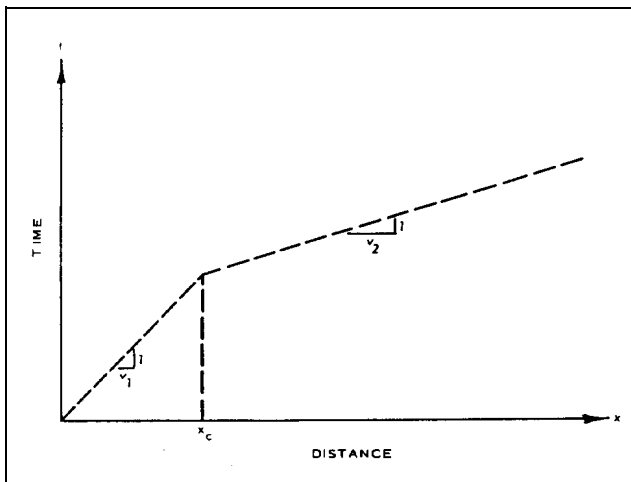

Figure 3-2. Time-versus-distance plot for seismic refraction survey of Figure 3-1

wave is a straight line with a slope equal to the reciprocal of the velocity of the surface layer  $V_1$ . For those raypaths refracted through the second layer, Figure 3-3 demonstrates that the distance traveled in the surface layer is the same for all geophones. Therefore, the travel-time difference from one geophone to the next is the time required for the wave to travel in the lower layer along a horizontal path whose length is the same as the distance between the two geophones. The portion of the curve representing the refracted wave is thus a straight line with a slope equal to the reciprocal of the velocity of the wave in the second layer. The crossover distance is the point where the first arrival is made up of refracted energy.

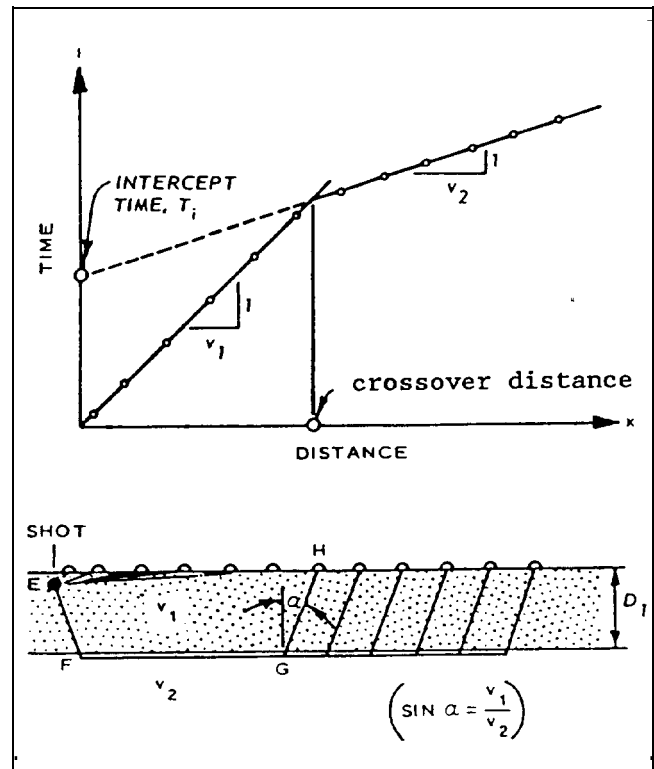

Figure 3-3. Simple two-layer case with plane, parallel boundaries, and corresponding time-distance curve (Redpath 1973)

(2) By consideration of Figure 3-3 two important equations can be identified, one for the intercept time and one for the crossover distance. The expression for travel

time in the refracted layer for the case of the plane layer parallel to the surface is given by

$$T_{sr} = (1/V_2) D_{sr} + 2D_1 (V_2^2 - V_1^2)^{1/2} / (V_1 V_2)$$

where

$T_{sr}$  = time to travel from source to receiver  
 (beyond the crossover distance)

$D_{sr}$  = distance from source to receiver

$V_{1 \text{ or } 2}$  = velocity of layer 1 or 2

$D_1$  = depth to first, flat lying interface

By analogy with a straight line whose equation is  $y = mx + b$ , the intercept time is the second term in the above equation:

$$T_i = 2D_1 (V_2^2 - V_1^2)^{1/2} / V_1 V_2$$

or

$$D_1 = (T_i/2) (V_1 V_2) / (V_2^2 - V_1^2)^{1/2} \quad (3-6)$$

where

$T_i$  = intercept time

These equations assume knowledge of  $V_2$  which is easily derived from the travel time curve for this case of flat, plane layers only.  $V_2$  is the inverse of the slope of the travel-time curve beyond the crossover distance (see Figure 3-3). Equation 3-6 can be used for a rudimentary form of interpretation and depth estimation as is discussed below in Section 3-2d.

(3) The other equation of interest is that for the crossover distance:

$$D_1 = (X_c/2) \{ (V_2 - V_1) / (V_2 + V_1) \}^{1/2} \quad (3-7)$$

where

$X_c$  = crossover distance

$D_1$  = depth to a horizontal refracting interface

and the other variables are defined above.

Equation 3-7 is most useful for survey design. Note that information about the lower layer is derived from arrivals beyond the crossover distance. Thus, the length of the refraction line must be longer than the  $X_c$  indicated by this equation.

(4) Figure 3-4 is a plot of velocity ratio ( $V_2/V_1$ ) versus crossover distance to depth ratio ( $X_c/D_1$ ). From that plot, if  $V_1$  is 1,500 m/s and  $V_2$  is 3,000 m/s, the crossover distance will be about 3.4 times the depth. Thus if the boundary under investigation averages 10 m of depth, data about the depth to the second layer would be recorded beyond 35 m (3.4 times 10 m) from the shot. A refraction line longer than 35 m (70 to 100 m is suggested) would be required to investigate the properties of the second layer.

c. *Interpretational methods.* Interpretational methods for refraction can be broadly grouped into the following three classes:

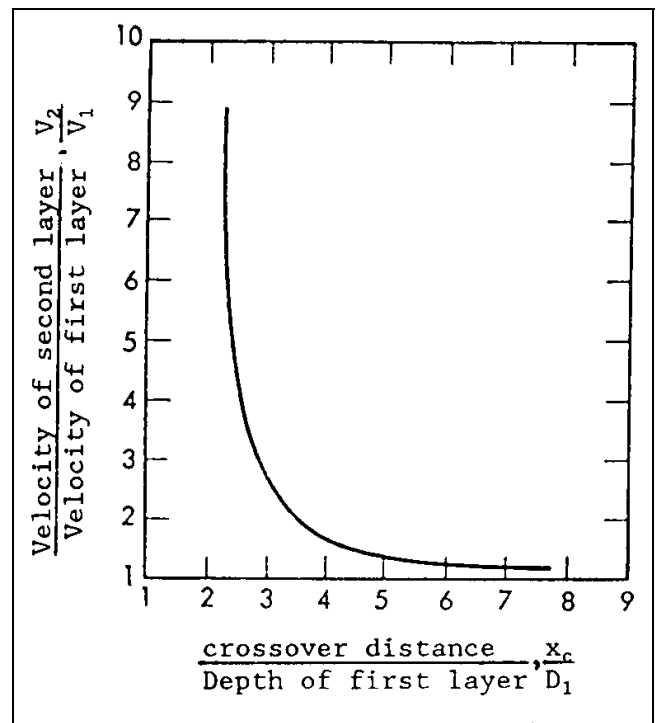

**Figure 3-4. Plot of ratio of crossover distance to depth of first layer as a function of velocity contrast (Redpath 1973)**

- (1) Intercept-time methods.
- (2) Reciprocal or delay-time methods.
- (3) Ray-tracing.

The level of computation required becomes progressively larger from method to method. Intercept-time methods can be done with pencil and calculator (or at most a spreadsheet computer program). Reciprocal time methods vary from a simple version (given below) to a generalized

version, which taxes most personal computers. Ray-tracing methods, in their most elaborate form, require significant computational resources.

d. *Time-intercept methods.* The basic equation for the time-intercept method is given above in paragraph 3-2b(2). It is interesting to note that Equation 3-7 for the crossover distance can also be solved for depth. This equation can be used to interpret data when, for some reason, the shot initiation time was not recorded (unknown cap delay, etc.).

(1) Single-dipping layer case. Incorporation of dip, as in Figure 3-5, yields several complications:

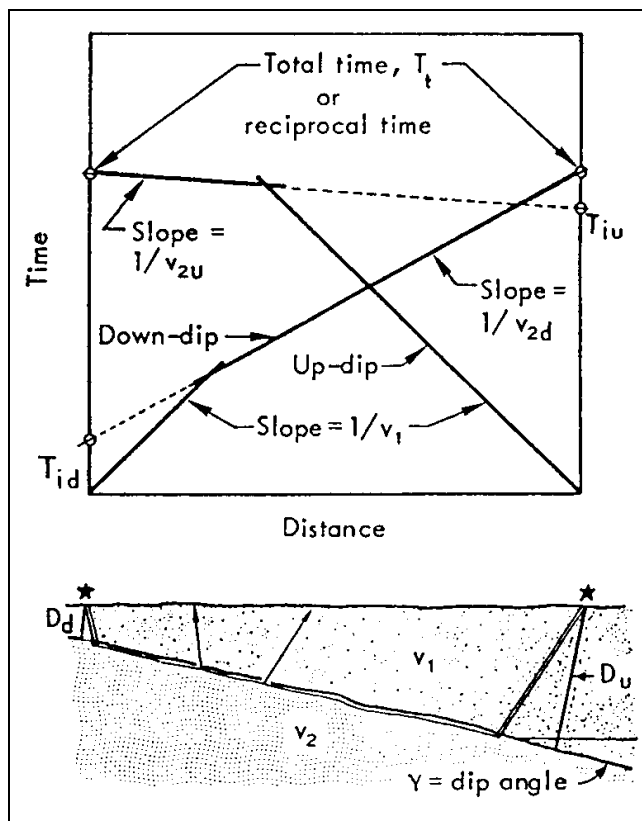

Figure 3-5. Example of dipping interface and concepts of "reverse shooting" and "apparent velocity" (Redpath 1973)

(a) Observed velocities of the lower layer are apparent velocities (corresponding to  $V_{2u}$  and  $V_{2d}$  in Figure 3-5) and vary significantly with dip (higher than the true velocity for up-dip, lower for down-dip).

(b) Depths, if determined from intercept times, are slant depths (corresponding to  $D_D$  and  $D_U$  in Figure 3-5) and not depths beneath the shotpoint.

(c) Reversed shots are required, as shots in only one direction measure an apparent velocity ( $V_{2u}$  or  $V_{2d}$ ) for the second layer.

Equations for the slant depths are:

$$D_u = V_1 T_{iu} / (2 \cos \alpha) \quad (3-8)$$

$$D_d = V_1 T_{id} / (2 \cos \alpha)$$

where

$D_u$  = slant depth under the up-dip shot

$D_d$  = slant depth under the down-dip shot

$V_1$  = velocity of the surface material

$T_{iu}$  = up-dip intercept time

$T_{id}$  = down-dip intercept time

$$\cos \alpha = (V_2^2 - V_1^2)^{1/2} / V_2$$

A useful approximation for  $V_2$  (which cannot be measured directly from the travel time curves) is

$$V_2 = (2V_{2u}V_{2d}) / (V_{2u} + V_{2d}) \cos \delta \quad (3-9)$$

where

$V_2$  = approximation to the velocity of the lower medium

$V_{2u}$  = apparent velocity of the lower medium measured up-dip

$V_{2d}$  = apparent velocity of the lower medium measured down-dip

$\delta$  = the approximate angle of dip of the section

An equation for  $\delta$  is

$$\delta = (1/2)(\sin^{-1}(V_1/V_{2d}) - \sin^{-1}(V_1/V_{2u}))$$

Often the cosine of  $\delta$  is approximated as 1.0, thus implying low dips. It should be stressed that the primary assumption in the use of intercept-time methods is that THE LAYER BOUNDARY IS PLANAR. Note that this assumption allows us to use information derived from observations (arrivals) beyond the crossover distance to derive a depth which is assigned to the vicinity of the

shot point. Nevertheless, these methods are useful for a pencil and paper estimate of depths and for a reality check on the more esoteric interpretational techniques.

(2) Multilayer cases. A multilayer case is illustrated in Figure 3-6 for flat-lying layers. Because of the ubiquity of a water layer, most shallow engineering surveys are three-layer cases. The principles of GRM remain the same, with overlap (arrivals from both directions) for all layers necessary. For flat-lying layers, the following time travel equations are useful for modeling purposes. The thickness  $D_1$  of the first layer is found by using the two-layer case and either the intercept time  $T_{i2}$  of the second line segment or the critical distance  $X_{c2}$  determined from the first two line segments. This thickness is used in computing that of the next lower layer  $D_2$  as follows:

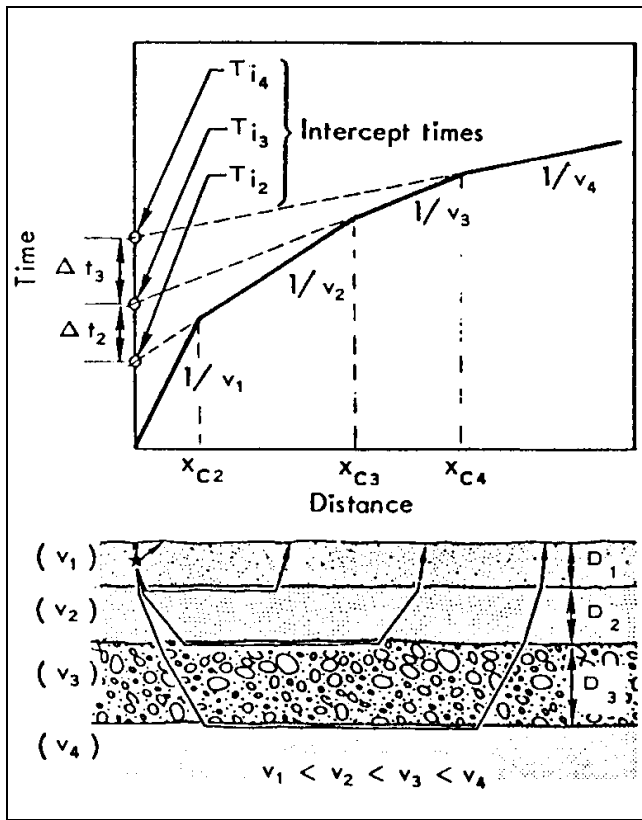

Figure 3-6. Schematic of multiple-layer case and corresponding time-distance curve (Redpath 1973)

$$D_2 = \frac{T_{i3} V_2 V_3}{2\sqrt{V_3^2 - V_2^2}} - D_1 \left( \frac{V_2}{V_1} \right) \sqrt{\frac{V_3^2 - V_1^2}{V_3^2 - V_2^2}} \quad (3-10)$$

where

$V_n$  = velocity of the nth layer

$T_{in}$  = nth intercept time

The equivalent of the above equation, in terms of critical distance, is:

$$D_2 = \frac{X_{c3}}{2} \sqrt{\frac{V_3 - V_2}{V_3 + V_2}} + \frac{D_1}{V_1} \left( \frac{V_3 \sqrt{V_2^2 - V_1^2} - V_2 \sqrt{V_3^2 - V_1^2}}{\sqrt{V_3^2 - V_2^2}} \right) \quad (3-11)$$

where

$D_n$  = depth to the nth refractor

$X_{cn}$  = nth crossover distance

The computations can be extended to deeper layers by use of either of the general equations:

$$D_n = \frac{T_{in-1} V_n V_{n-1}}{2\sqrt{V_{n-1}^2 - V_n^2}} - \sum_{j=1}^{n-1} D_j \left( \frac{V_n}{V_j} \right) \sqrt{\frac{V_{n-1}^2 - V_j^2}{V_{n-1}^2 - V_n^2}} \quad (3-12)$$

and

$$D_n = \frac{X_{cn-1}}{2} \sqrt{\frac{V_{n-1} - V_n}{V_{n-1} + V_n}} + \sum_{j=1}^{n-1} \frac{D_j}{V_j} \left( \frac{V_{n-1} \sqrt{V_n^2 - V_j^2} - V_n \sqrt{V_{n-1}^2 - V_j^2}}{\sqrt{V_{n-1}^2 - V_n^2}} \right) \quad (3-13)$$

Because the equations in this form contain the thicknesses of shallower layers, the computation begins with the first layer and progresses downward. Note that these equations do not incorporate dip. The equations for dipping plane layers are found in Palmer (1980).

*e. Reciprocal methods.* Reciprocal methods include more than 20 methods of interpretation, including those

lumped under the heading of delay-time methods (which may or may not require the measurement of a reciprocal time). The definition of reciprocal time is the travel time along the refractor from one shotpoint to another shotpoint.

(1) Simple reciprocal method. Figure 3-7 illustrates one version of the method. From the figure it can be seen that  $T_{AG} + T_{BG} - T_{AB}$  is equal to the sum of the slant times plus a small time corresponding to travel between the two points where the raypaths emerge from the refractor. For flay-lying, near-plane refractors, these times can be converted to a distance by the equation

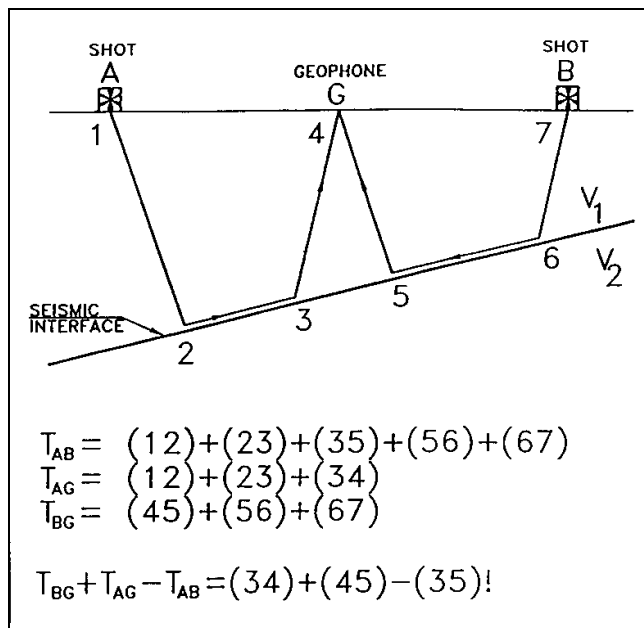

Figure 3-7. Development of simple reciprocal-time method equations

$$Z_G \approx (2V_1 / \cos \alpha)(T_{AG} + T_{BG} - T_{AB})$$

where

$Z_G$  = distance to the refractor from the geophone G

$T_{AB}$  = travel time from shotpoint A to shotpoint B

$T_{AG}$  = travel time from shotpoint A to geophone G

$T_{BG}$  = travel time from shotpoint B to geophone G

$V_1$  = velocity of the upper layer

$\cos \alpha$  is given by  $(V_2^2 - V_1^2)^{1/2} / V_2$

Note that the calculation of  $\cos \alpha$  requires the value of  $V_2$ . As above, a satisfactory approximation is given by Equation 3-9. The angle  $\delta$  is an approximation of the dip for the whole line.

(2) Calculations of depths using this method can easily be completed using a calculator and pencil and paper. Two caveats are in order for this version of reciprocal time methods. One is that "Tab" must be the time on the same refractor from shotpoint to shotpoint. In the presence of deeper refractors, care must be exercised that the reciprocal time is accurate. Secondly, note that the approximations are based on "low" dip. Generally 10-15 deg is an acceptable range.

(3) The distance obtained is measured from the location of the geophone in three dimensions. Thus, there is no requirement for a datum as the distance (depth) is measured from the geophone elevation. Note that the direction is not specified, thus an arc of acceptable points on the refractor is actually defined by this distance. It is instructive to prepare a display of the loci of acceptable solutions for an irregular refractor which is made up of the arcs for all of the geophones along a line (Figure 3-8).

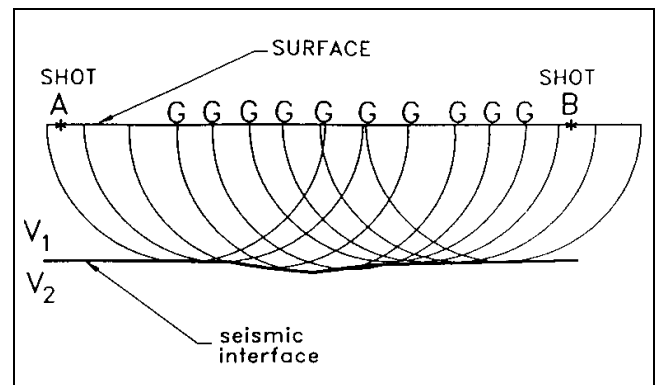

Figure 3-8. Illustration of loci of time depths

(4) Generalized reciprocal method (GRM). Detailed consideration of the above simplified method reveals two major problems when it is applied to extreme topography on the ground surface or subsurface interfaces. First in the determination of  $V_2$ , the above method utilized an average  $V_2$  over a large section of the travel-time curve. Secondly, in the derivation, the segment on the refractor (segment 3-5 in Figure 3-7) was ignored. The generalized reciprocal method or GRM (Palmer 1980) was developed to overcome these and other shortcomings of simpler methods.

(5) Palmer's method derives two functions: the velocity analysis function and the time-depth analysis function. One facet of the method is the use of arrivals at geophone points on either side of the geophone being considered (positions X and Y in Figure 3-9).

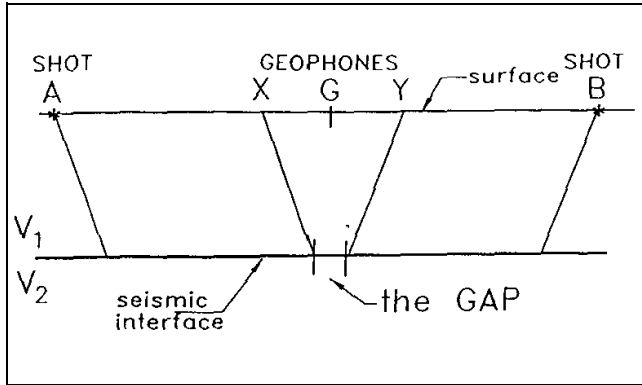

Figure 3-9. Spatial relationships in the GRM methods

(6) Velocity analysis function. Figure 3-10 indicates the derivation of the velocity analysis function. Following the previous nomenclature, this function is formed for  $T_{AB} - T_{AX} - T_{BY}$ . From Figure 3-10, it is seen that this time represents travel time from the shot A to a point on the refractor. If this time is plotted versus geophone position, an accurate  $V_2$ , irrespective of dip or refractor topography can be derived (Figure 3-10). One variable of this arrangement is  $XY$ . Figure 3-11 depicts how this factor affects the calculation of  $V_2$ . If  $XY$  is chosen so that the exit point on the refractor is common, the travel time, and thus the calculation of  $V_2$ , is dependent only on the material itself. If an incorrect  $XY$  such as  $X'Y'$  is chosen, structure of arbitrary shape is incorporated in the travel time and thus in the velocity calculation.

(7) Most computer programs performing a GRM prepare an estimate of the travel time given above as a function of  $XY$ . Under the assumption that  $V_2$  is constant or slowly varying, inspection of these curves will indicate which  $XY$  is correct. The  $XY$  showing maximum smoothness (less structure) will conform to the geophysical assumption that is valid for most geology. This part of the process has a twofold purpose, to map  $V_2$  across the spread, and to estimate  $XY$ , an important factor to be used in the next section.

(8) Time-depth analysis function. Figure 3-12 indicates the definition of the time-depth analysis function  $T_G$ :

$$T_G = T_{AY} + T_{BX} - T_{AB} - XY/V_2$$

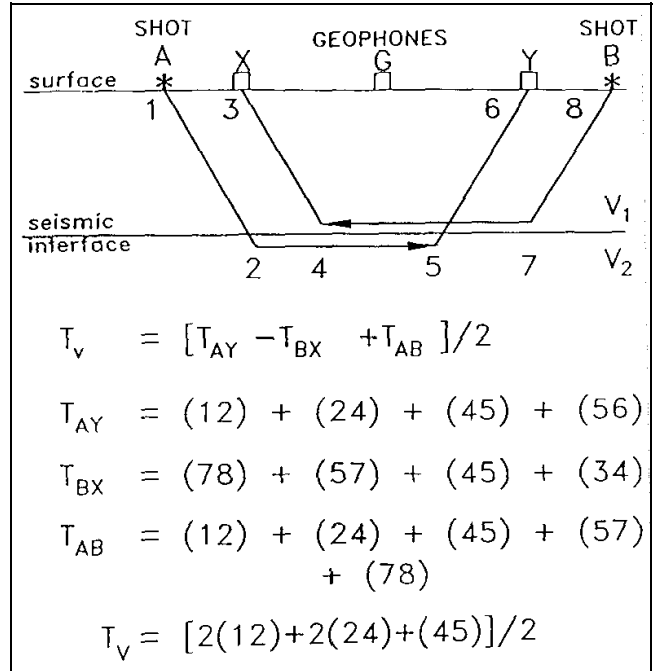

Figure 3-10. Definition of the velocity analysis function

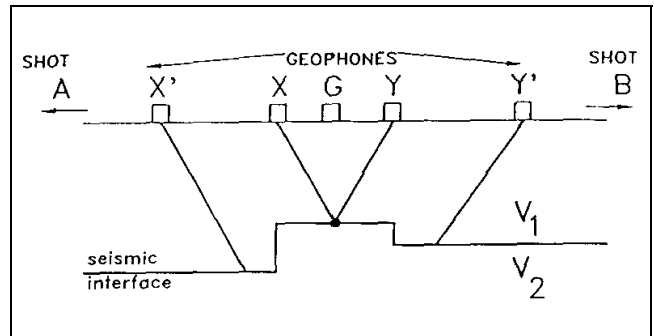

Figure 3-11. Illustration of error in determination of velocity analysis function

where the variables are defined above.

(9) From the analysis in Figure 3-13, it is seen that  $T_G$  represents the two travel times for the slant depths and a correction factor for the distance traveled at  $V_2$  (4-5 in Figure 3-13). This time-depth is analogous to the one developed in the simpler reciprocal method given above but one which can be converted to a depth with a more robust approximation. Before attacking that problem, consider the effects of  $XY$  on the calculation of  $T_G$ . Figure 3-14 indicates that if  $XY$  is chosen so that the exit points are the same in both directions, the effects of any propagation at  $V_2$  are minimized and the actual structure is mapped. If  $X'Y'$  is chosen, a smoothing of consecutive time-depths will occur.

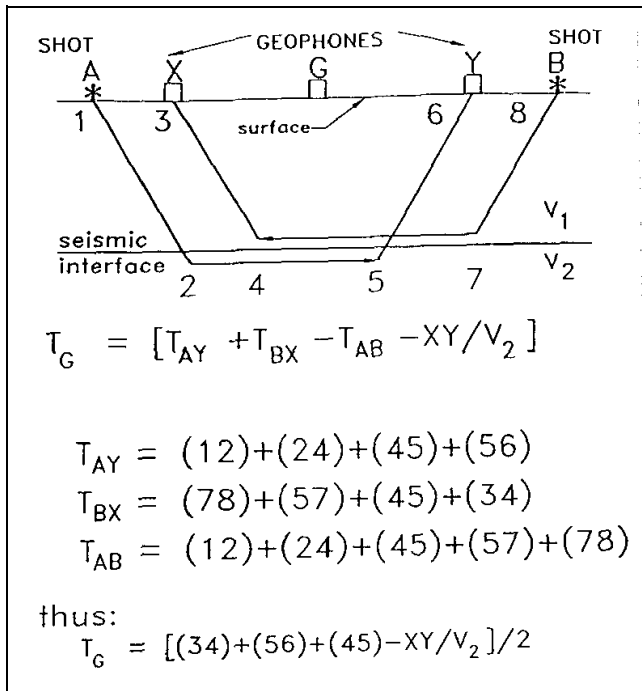

Figure 3-12. Definition of time-depth analysis function

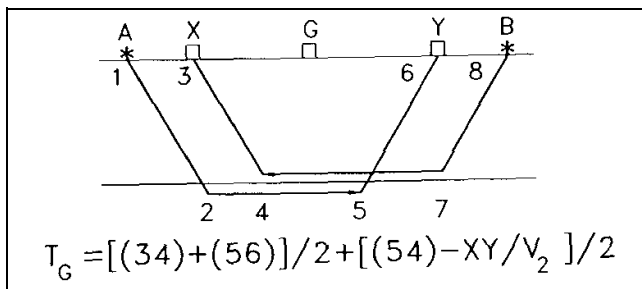

Figure 3-13. Relationships in the time-depth determinations

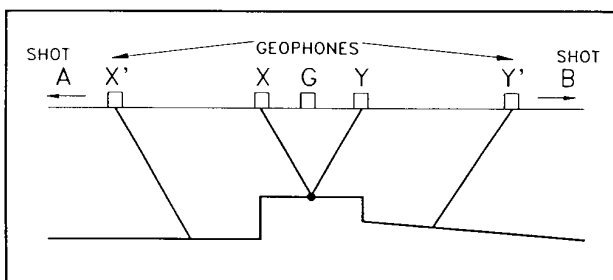

Figure 3-14. Illustration of error in determination of time-depth analysis function

(10) Most computer programs calculate the time depths for several sets of XY's. Under the assumption

that the structure is irregular, the set of time depths with "maximum roughness" is chosen. Thus another estimate of XY is obtained in addition to the one obtained from the velocity analysis function.

(11) Optimum XY. If a model is completely defined; that is, depths and velocities are given, the best XY; that is, the XY with a common exit point on the refractor, can be calculated for flat-lying layers. Figure 3-15 indicates a simple derivation of XY for the flat-lying case. This value of XY, the third in the series, is called the optimum XY. A consistent, complete interpretation will produce a near equal set of XY's. Hidden layers and velocity inversions (both defined later) will manifest themselves as variations in the appropriate XY's.

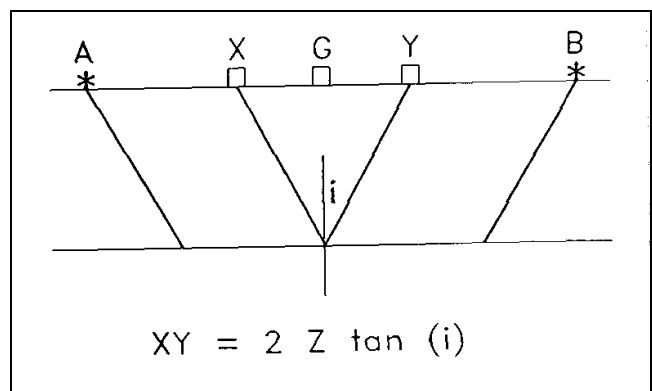

Figure 3-15. Definition of optimum XY

(12) As before, the conversion of time-depths to actual depths requires a velocity corresponding to the slant-distance travel in the upper layer. Palmer gives an acceptable approximation as

$$Z_G = T_G V_1 V_2 / (V_2^2 - V_1^2)^{1/2}$$

which is a sound approximation for low dip angles (up to about 15 deg). As in the previous derivation, this distance is independent of direction and determines only a loci of possible refractor locations (see Figure 3-8).

(13) A full GRM interpretation requires the following data:

(a) An arrival time from the same refractor from both directions at each geophone.

(b) A reciprocal time for energy traveling on that refractor.

(c) A closely spaced set of geophones so that a variety of XY's can be calculated.

(14) These requirements imply a significant increase in the field effort. Geophone spacings of one fourth to one eighth of the depth to the refractor may be required. The number of shots is determined by requirement 1 above, arrival times from both directions on the same refractor. Shot-to-shot distances longer than twice the crossover distance for the first refractor are required. If deeper refractors are present, the shot-to-shot distances must be less than the crossover distance of the deeper refractor. For poorly expressed (almost hidden) and thin layers, the number of shots required may be cost-prohibitive.

*f. Ray-tracing methods.* Ray-tracing programs usually derive some first approximation of a model based on one of the methods described above. A calculation of the expected arrival time at a geophone based on the starting model is then calculated. This calculation becomes quite involved as the complexity of the model increases. As there is no closed form solution for the calculations, iterative methods of generating raypaths are used and convergence must sometimes be forced as the models become more complex.

(1) After the model times have been calculated for the arrivals at the geophones, some form of model adjustment is made which will cause the calculated times to become closer to the observed times. Once the adjustment is made, the process starts over again with calculation of travel times based on the adjusted model. This process is a form of geophysical inversion, i.e., production of a geophysical model which accounts for the observations by calculation of the responses of a model and adjustment of that model. Successful geophysical inversions have several general properties:

(a) The number of observations is generally several times larger than the number of parameters to be determined (that is, the number of shots and observed travel times is far larger than the number of velocities, layers, and inflection points on the layers).

(b) The geophysical model is substantially similar to the geological model being measured (i.e. the approximately flat-lying, low-dip geophysical model is not forced on a geological model of vertical bedding with significant horizontal velocity changes between geophones).

(2) Ray-tracing programs using the appropriate approximations necessary for computation on personal computers are available and are stiff competition for programs based on generalized reciprocal methods.

*g. Models.* A pitfall of the reciprocal time methods is that they do not lend themselves to the generation of a forward model. Calculations based on Equation 3-6 are often sufficient and will be illustrated here.

(1) A geophysical investigation is proposed based on a geological model consisting of:

- (a) An alluvial layer 5 to 8 m thick.
- (b) Basalt bedrock.
- (c) Groundwater 3 to 9 m from the surface.

The problem is to map low spots in the bedrock for siting monitoring wells.

(2) The problem is first converted to a geophysical model.

	Thickness (m)		Velocity (m/s)	
	Min	Max	Min	Max
First layer (alluvium above the water surface)	3	8	450	750
Second layer (water- saturated alluvium)	0	5	1,500	1,700
Third layer (bedrock surface)	--	--	3,000	4,300

(a) The following subtle assumptions are implicit in this geophysical model:

- Alluvium (above the groundwater surface) is fairly dense, thus potentially higher velocities of 450 to 750 m/s are postulated.
- Where saturated (possibly as shallow as 3-m depth), the alluvium will have a velocity near that of water, 1,500 m/s (the second layer may be absent (0-m thickness), when the water surface is beneath the basalt's depth - as shallow as 5-m depth).
- The top of the basalt is not weathered and the basalt is generally homogeneous (thus velocities



between 3,000 and 4,300 m/s are indicated, independent of the groundwater surface level).

Depth and velocity values larger or smaller than those given are tested to define the limits of the investigation program.

(b) Four cases are considered:

- Models 1a and 1b: Dry models (layer 2 absent) with alluvial thicknesses of 3 and 8 m. Variation in the bedrock velocity is accounted. Travel time curves for Model 1 are illustrated in Figure 3-16.
- Models 2a and 2b: Wet (layer 2 present) models with 8 m of alluvium, 5 m of it saturated, and the upper 3 m unsaturated. The bottom layer's velocity is held at 3,000 m/s and the surface layer's velocities of 450 and 750 m/s are considered. Travel time curves for Model 2 are found on the bottom of Figure 3-16.

(c) Given these model travel-time curves, the following generalizations can be derived:

- Arrivals from the surface layer are only present within 9 m of the shotpoint (3-m geophone spacings are barely small enough to get enough data on the velocity of the surface layer).
- Only a small portion of the travel-time curve is due to refraction from the water layer (thus geophone spacings of 3 m would probably not be small enough to resolve the layer).

(3) Based on the modeling, the following programs could be proposed:

(a) If the layers are flat, contiguous, no faults are suspected, and any bedrock lows are thought to be broad swales (wavelengths greater than 60 m), then a shooting plan based on time-intercept interpretations is possible. (Because of the narrow window available for both surface and water-layer arrivals, geophone intervals of less than 3 m are recommended. As data will be obtained at each shotpoint, shotpoint spacing and line spacing are functions of the data density required. A typical setup might be 2.5-m or smaller geophone spacings, 24-channel recording and shots at both ends and in the middle of each spread of 24 receivers. Note that reversed shots are required (dip is expected) and that arrivals from the water layers may be present on only some of the travel-time curves (see next section on blind layers).

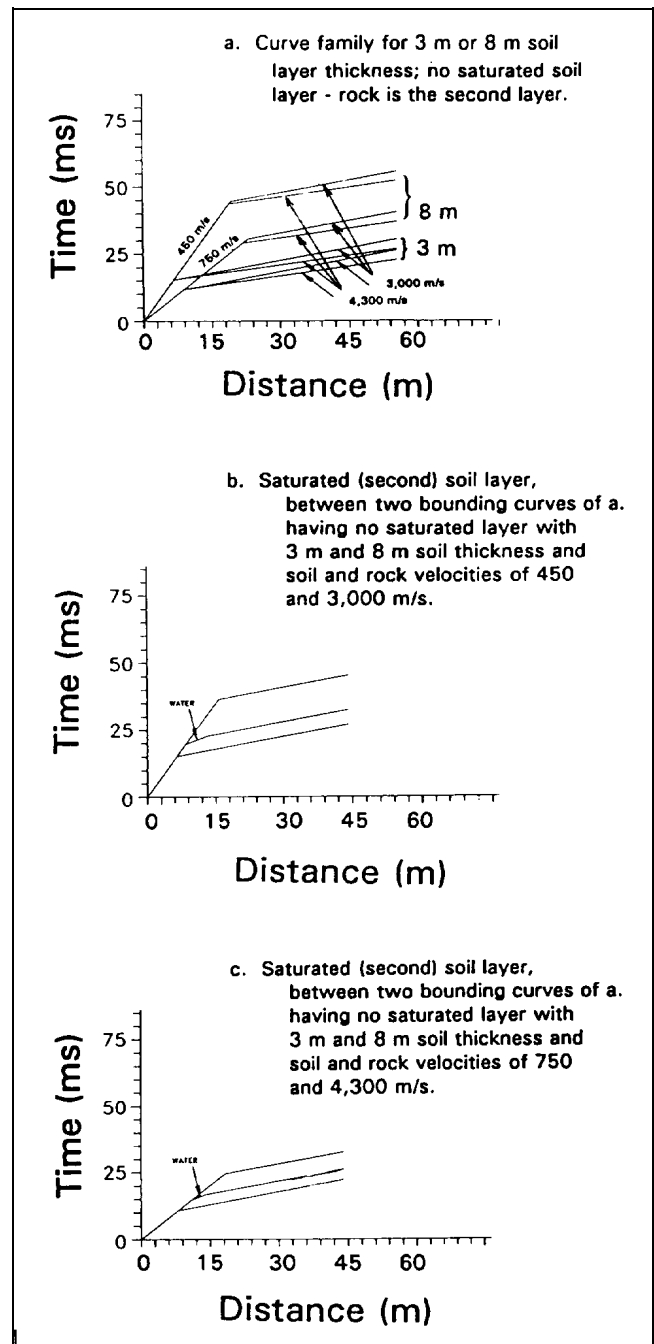

**Figure 3-16. Models of travel-time curves. Time in ms; distance in units of ft (0.3 m = 1.0 ft)**

(b) If the geologic model includes channels cut into the basalt and if the surface of the basalt can exhibit significant structure (say 2- to 3-m elevation changes of channel banks), then a full GRM approach should be taken. The GRM approach to this problem includes the following:

- Geophone spacings of 1.5 m are chosen (to generate a representative set of *XY* values, a small interval is necessary).
- One pair of shotpoints offset from the ends of the spread by at least 25 m (thus each geophone will have an arrival from both directions from the high-velocity layer).
- Several sets of shotpoints about 20 m apart. Water arrivals are not present over a very wide range of distances (7 to 12 m in the best case in the models). Thus, shot pairs at these spacings will have to be repeated at least three or four times per spread to get adequate data about the water-bearing layer (see paragraph 3-2i(2)(a) on blind layers).

Thus, a minimum of 10 source locations into a 24-channel spread of 35-m length will be required to generate data adequate for a GRM interpretation. Note that a careful monitoring of the field data is required as the velocities and depths are not usually constant across basaltic terrain.

*h. Field work.* For routine engineering-scale surveys, two to four persons are engaged on a seismic refraction crew. A crew of two will be considerably slower than a crew of three; a crew of four marginally faster than a crew of three unless extensive shothole preparation is necessary. Several fine points of field work to be considered are:

(1) In addition to surveying of the relative locations of shotpoints and geophones to a few percent of the geophone interval, the absolute location of the line should be tied to permanent fiducials at several points. How much error is significant depends on the scale of the problem and the velocities involved. One millisecond (ms) represents 60 cm of travel at 600 m/s, but 3 m at 3,000 m/s. A 30-cm survey error similarly contributes 1/2 to 1/10 ms of time error. The scale of the problem is important. Where closely spaced geophones (3 m or less) and high-frequency signals are used, a 30-cm error is not acceptable. For crustal-scale problems, 30-cm survey error is insignificant.

(2) Electrical noise, usually 60 Hz (cycles per second) in the United States, may be dealt with by the use of internal filters in the seismograph. All filters, analog or digital, cause some time delay of the seismic impulse. Thus, filters should not be adjusted in the course of a survey except in the most unusual circumstance. If not

adjusted, the filter delay becomes part of the accuracy problem, not a precision problem.

(3) Source strength can be adjusted by a variety of techniques; more explosives should be the last technique implemented. Improved coupling for hammer plates or shots (usually by digging a shallow hole), selection of an alternate shot point, more hammer blows, bigger hammers, and other techniques which will occur to the resourceful geophysicist should be tried first. Note that the theoretical variance of random noise due to an increased number of hammer blows decreases as the square root of the number of blows. Thus, unless the shotpoint is particularly important or the cost of physical labor negligible, a practical maximum number of blows is between 10 and 25.

(4) Wet weather causes productivity problems for equipment and personnel. Most geophone-to-cable connections are not waterproof and it is easy to develop a geophone-to-geophone ground loop. The direct impact of raindrops on geophones is easily recorded.

(5) Frozen ground can contribute a high-speed, near-surface path which will obscure the contribution of deeper layers. The P-wave velocity of ice is near 3,800 m/s.

(6) Wind effects can be minimized by putting geophone cables flat down on the ground, anchoring geophone wires, and removing measuring tapes, which flutter in the wind. Geophone burial is a labor-intensive but moderately effective method of dealing with the wind if the wind is not coupled to the ground by nearby vegetation. Sometimes filters will assist in the removal of high-frequency wind or water noise, but paragraph 3-2h(2) above should be considered when using filters.

(7) While human errors cannot be eliminated, the consequences of carelessly placed geophones, improperly recorded locations, and generally sloppy work should be impressed on the entire field crew so that the results produced will be meaningful.

(8) The acoustic wave transmitted through the air may be the first arrival in cases where very low-velocity alluvium is present. In shear-wave work, velocities are often below the velocity of sound in air (345 m/s at standard conditions). Geophone burial and recognition of the acoustic wave when picking the records are mitigation for this source of noise. The air arrival will often cause a first-break of opposite polarity to that caused by transmission through earth materials.

*i. Interpretation.*

(1) Evaluation of programs. While the geophysical capabilities of commercially available interpretation programs are an obviously important part of any buying decision, the ease of use and applicability of the so-called “front-end” and “back-end” of the program should be carefully considered. Specifically:

(a) Refraction field efforts, even of moderate size, generate enormous amounts of data.

(b) Post-analysis output may be the most important part of the project.

It is imperative to minimize the manual handling of the data. The geometry is entered in the seismograph in the field, a picking program is used to find the first breaks, and these data streams converge in the analysis program. Convenient editing and correction facilities, graphical displays to confirm the correctness of the data entry, and seamless integration are important. A wide variety of printers and plotters for post-analyses should be supported, including the generic digital graphics interchange formats. No matter how good the plate output of the program looks in demonstration, eventually the user will have to do CAD work to get information in the desired form.

(2) Pitfalls. The two most difficult geologic conditions for accurate refraction work are the existence of a thin water-saturated zone just above the bedrock and the existence of a weathered zone at the top of bedrock. These two difficult problems are members of the class of blind zone and hidden layer problems.

(a) Blind zone. The model of paragraph 3-2g is redrawn in Figure 3-17 to emphasize the area immediately above the refractor (shaded). This area is known as the blind zone. Calculation reveals that depending on thickness and velocity, no information (arrivals) will be received from this shaded layer. For velocities lower than  $V_1$ , clearly no refraction will occur. For velocities greater than  $V_1$  but less than  $V_2$ , the travel time curves for a thin zone are shown in Figure 3-18. As thickness or velocity increases, the solid line in Figure 3-18 occurs at earlier times until first arrival information (however sparse) is received from the shaded area. All refractors have a blind zone whose size depends on the depth and velocity distribution.

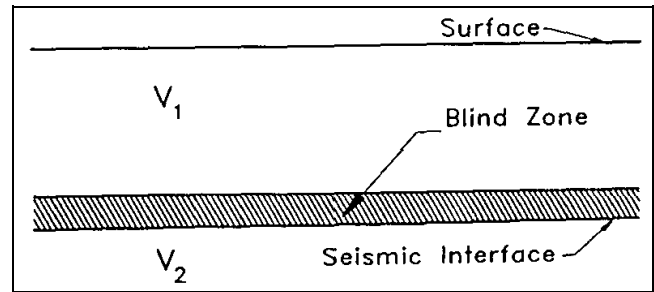

Figure 3-17. Illustration of locating blind zones

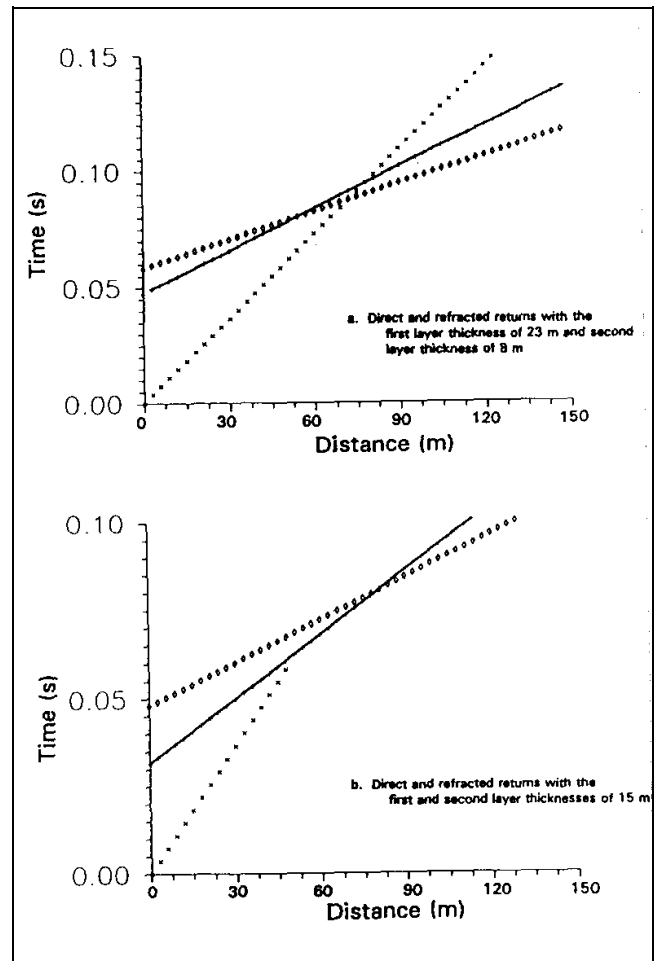

Figure 3-18. Travel-time curves for the hidden-zone problem (0.3 m = 1.0 ft)

(b) Hidden layer. Within all blind zones, there may be a hidden layer of water or weathered bedrock which cannot be detected by the refraction work. Obviously, if the velocity in the blind zone is equal to  $V_1$ , there is no

problem and the interpretation proceeds without error. Other hidden layer issues are the following:

- Water is particularly troublesome, because it often increases the velocity of poorly indurated alluvium to an intermediate velocity between that of unsaturated alluvium (usually 300 to 900 m/s) and bedrock (usually above 2,000 m/s). (The acoustic velocity for water at standard conditions is about 1,500 m/s.)
- Weathered bedrock can act similar to saturated soil. The potential for very rapid lateral changes in the thickness of the weathered layer makes refraction work in saprolitic and similar terrains a difficult proposition. Careful planning and added drilling work could be required.

(c) Two-dimensional assumption. The assumption in the interpretation methods discussed above is that the problem is two-dimensional, i.e., there is no variation of the rock properties or geometry perpendicular to the line. However, the dips measured along lines are apparent dips and a correction is needed to recover true dip.

(d) Inhomogeneity. Some materials, especially glacial deposits or thick man-made layers of uncompacted sediments, will exhibit a continuous increase in velocity with depth. Travel-time curves with a continuous curve or change of slope are an indicator of this situation. Where an approximation of this type of travel-time curve by straight line segments is unsatisfactory, methodology does exist to derive velocity functions of the form of a linear increase with depth or with two-way travel time from the curved travel-time curves (Duska 1963; Hollister 1967).

(3) Case examples. Several common geologic situations which can produce confusing travel-time curves are illustrated in Figures 3-19 to 3-23. Note that other, perhaps less geologically plausible, models could be derived to fit the travel-time curves shown.

(a) Figure 3-19 indicates a simple change in dip. Note that three velocities are recorded, but only two materials are present. Figure 3-20 represents one-half of a buried stream channel and, perhaps in the context of Figure 3-19, is not hard to understand. However, note that four velocities are present. Because the opposite bank of the stream may be present, perhaps on the same spread, the picture can get very complicated.

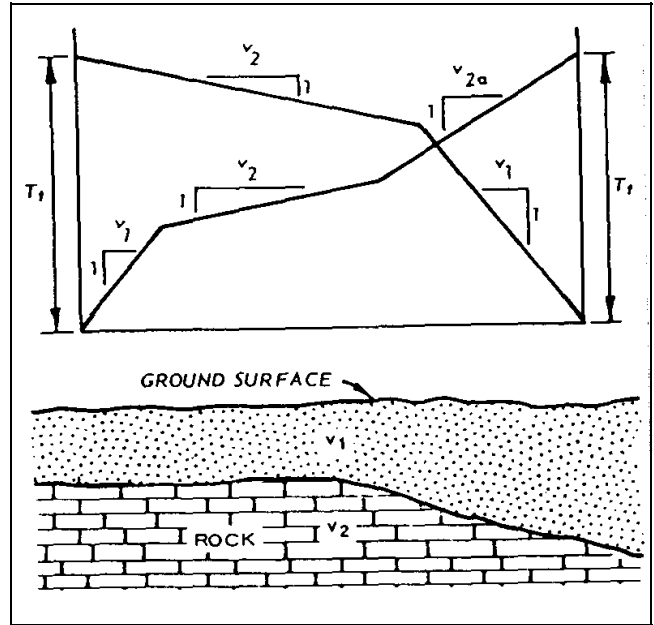

Figure 3-19. Change in dip of refractor surface

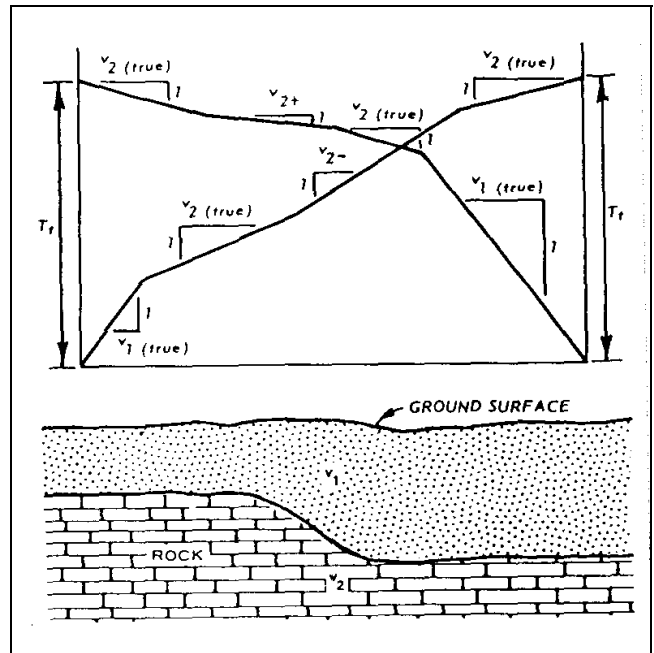

Figure 3-20. Subsurface stream channel

(b) Figures 3-21 and 3-22 indicate another set of models for travel-time curves. Figure 3-22 models a discontinuity in the rock surface and the resultant travel-time curves. Note that the discontinuity causes a delay in both directions while the fault both advances and delays

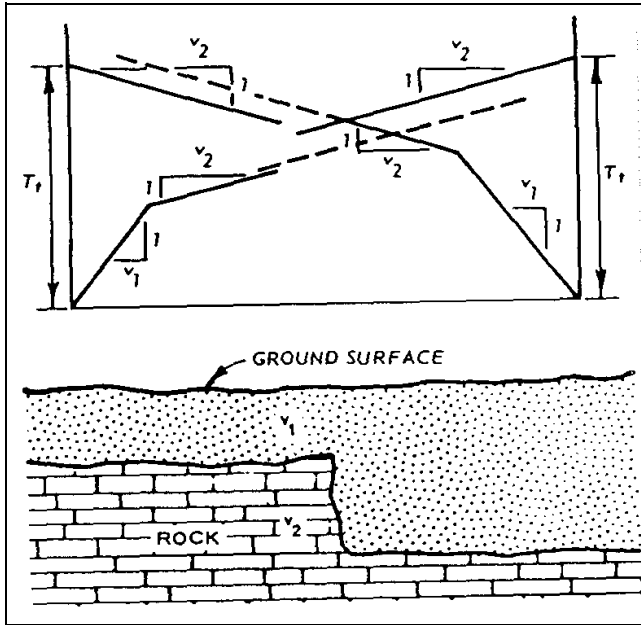

Figure 3-21. Subsurface cliff

the trend of the travel-time curves. One warning about the attempted detection of voids or discontinuities is in order. Fermat's principle says that the discontinuity must extend significantly perpendicular to the profile in order that no fast path detour is present that will minimize the observed delays.

(c) Figure 3-23 is a common setup where a single spread spans a channel. Three velocities are recorded (two of them apparent), if shots are fired only at the ends. When doing cross-channel work, a center shot is usually required to derive the true velocities and geometry from the data recorded.

g. *Shear waves.*

(1) Shear wave (S-wave) measurements have several advantages in engineering and environmental work.

(a) The engineer can relate S-wave velocities more easily to shear moduli and other properties used in engineering calculations. If both compressional (P-wave) and S-wave velocities are measured, Poisson's ratio and other engineering constants can be derived.

(b) In saturated, unconsolidated materials, P-wave velocities are often controlled by water velocity. As S-wave propagation is generally unaffected by the presence of a liquid, S-wave studies are not complicated by

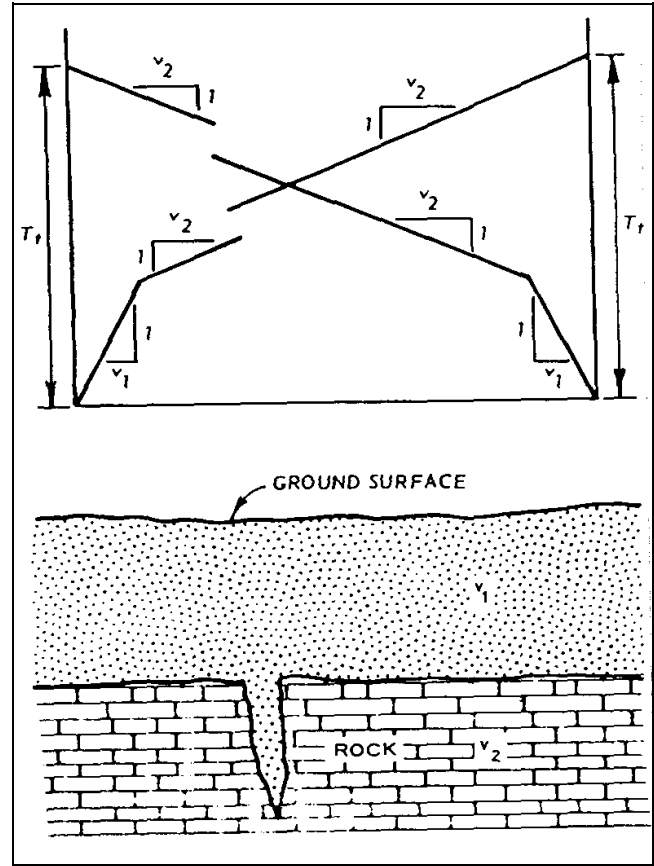

Figure 3-22. Offset in time-distance plot due to discontinuity in rock surface

the location of the water surface. A difficult three-layer P-wave case can become a routine two-layer S-wave case.

(c) As the S-wave measurement by its nature includes a large volume of in situ material, the bulk velocity measurement may be more relevant to the performance of engineered materials than point samples.

(d) S-wave studies are interpreted in the same way as P-wave studies. Differences consist mostly of field technique and some data display methods which will be discussed below.

(2) S-Wave Field Work and Data Recording. S-wave sources have one advantage and one disadvantage which merit discussion. In general, S-wave sources are not as energetic as P-wave sources—there is no “more explosives” alternative to turn to in S-wave work. While large mechanical contraptions have been designed to impart an impressive traction to the ground, their signal strength and reliability remain suspect. The advantage

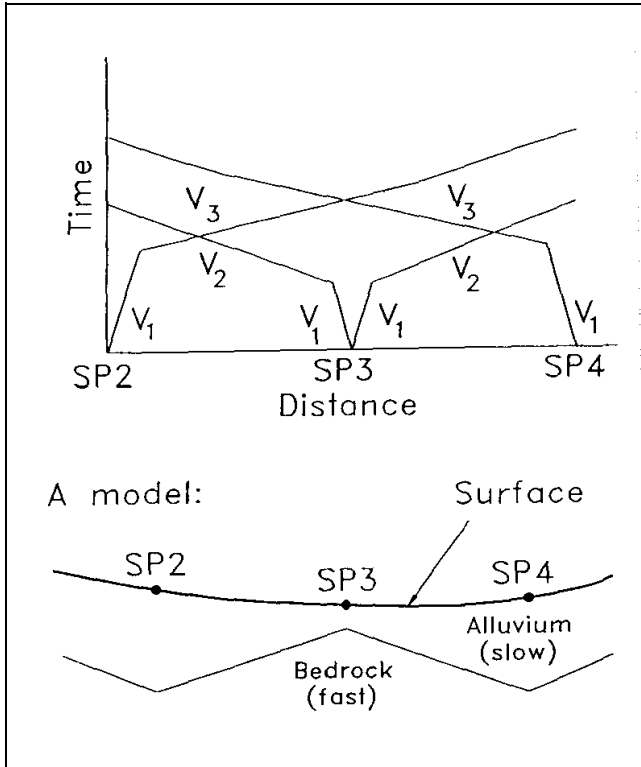

Figure 3-23. Cross-channel travel-time schematic

that S-wave sources have is that they have two polarities, both of which can be stacked together to produce record enhancement.

(3) SH-waves, the waves that have particle motion perpendicular to the line of geophones (see Figure 3-24), are preferred for shallow refraction work. This choice minimizes the conversion of S-waves to P-waves at any interface encountered. Thus, a source which produces a traction perpendicular to the line and parallel to the surface is specified (see Figure 3-24). A truck-weighted plank struck on the end with a hammer is the classical source. Portable versions of this type of source and other energetic mechanical sources are available.

(a) Receivers with their sensitive axis oriented perpendicular to the line are also used. Horizontal axis geophones are required, and leveling of each geophone is generally necessary. The geophone axis should be carefully aligned perpendicular to the line and with common polarity (direction).

(b) To utilize the switchable polarity of the source, one field technique is as follows:

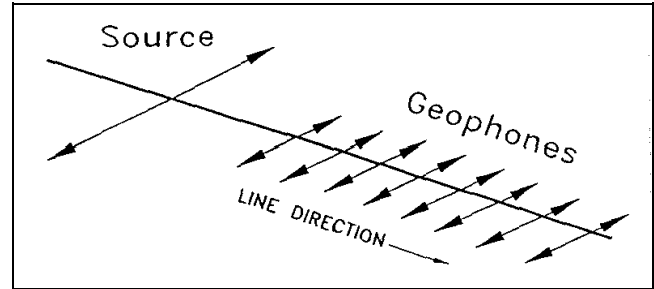

Figure 3-24. Source and geophone directions for SH waves

- Shoot (hit) the source in the direction of the polarity of the geophones (stack enough hits to produce reasonable first-breaks with an apparent velocity expected for the known geology of the area. Pitfalls in this stage are the prominent air-blast (345 m/s) and a P-wave water refraction (about 1,600 m/s). Neither of these is the target but either may be the most prominent portion of the record. This first shot is recorded (saved to disk on most modern seismographs) and is called the positive-source-positive-spread record).
- Without erasing the seismograph's contents, move to the other side of the source (this move changes the polarity of the source. Also change the recording polarity of the spread (in most seismographs, this change is accomplished by turning a convenient software switch). To the extent possible, the number of hits and source signature are repeated with the reversed polarity source stacking the data onto the positive-positive record. Save this record as the "stacked" record).
- Clear the seismograph and record the same record (negative source only) as in the previous step. (This record is called the negative-source negative-spread record and is also saved.)

Thus, three records are recorded for each shotpoint. The stacked records enhance the S-wave information and suppress the P-wave information. This suppression takes place because the reversal of the polarity of the source and receivers amplifies the S-wave, but any P-wave energy which has constant polarity is subtracted due to the polarity change. This procedure is illustrated in Figure 3-25.

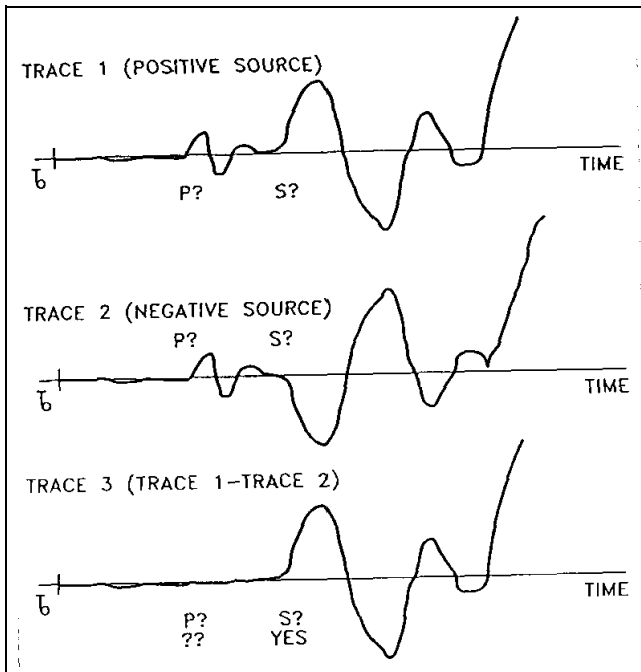

Figure 3-25. Multiple S-wave recordings

(c) If the stacked record is of good quality, only cursory examination of the other two records is necessary. However, it is often necessary to use the other records to positively identify the S-wave arrivals if P-wave interference is present. A dual-trace presentation is used to confirm the S-wave arrival.

(4) A sample dual-trace presentation is shown in Figure 3-26. The negative-negative record has been plotted with reversed (again) polarity. Thus any P-wave energy should cause the two traces to move together but any S-wave energy should cause the two traces to diverge. Where the two traces diverge, positive confirmation of S-wave energy is attained. Each shot record may have to be played out in this format to attain positive identification of the S-wave energy.

(5) Additional Considerations. Two fine points of S-wave work are:

(a) Considerable noise suppression of the air-blast and other converted waves can be realized by covering the geophones with some dirt.

(b) Efforts to couple the traction plank or other device to the ground are worthwhile. In soft farmland, the coupling is generally good, but on a rutted gravel road the amount of S-wave energy generated may be small without some shovel work.

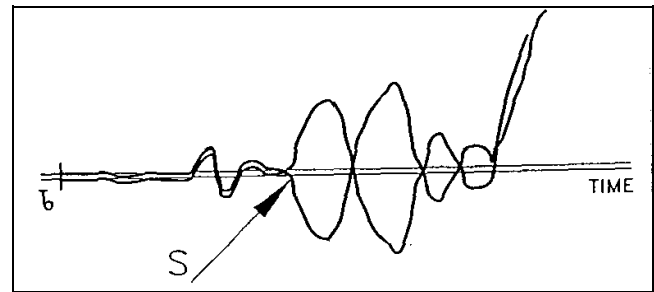

Figure 3-26. Dual-trace display

(6) Shear-wave example. A common record in S-wave studies is indicated in Figure 3-27. Arrivals as picked are plotted and the velocity of sound in air is shown for reference. Obviously, sound is going to be a problem at two points on the record.

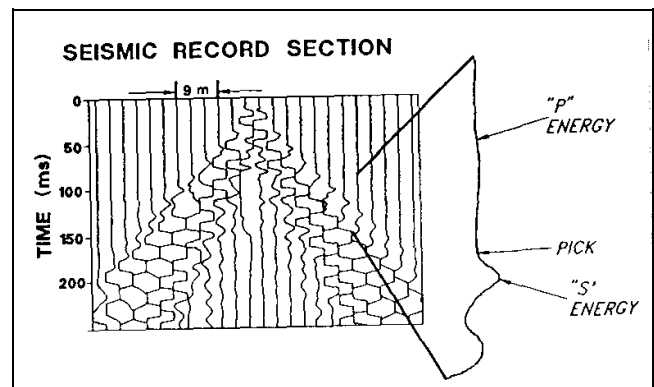

Figure 3-27. Example of shear-wave record. Expanded trace identifies "S" and "P" energy confirmed by dual trace plots

### 3-3. Shallow Seismic Reflection

A portion of the seismic energy striking an interface between two differing materials will be reflected from the interface. The ratio of the reflected energy to incident energy is called the reflection coefficient. The reflection coefficient is defined in terms of the densities and seismic velocities of the two materials as:

$$R = (p_{b2}V_2 - p_{b1}V_1)/(p_{b2}V_2 + p_{b1}V_1) \quad (3-14)$$

where

$R$  = reflection coefficient

$p_{b1}, p_{b2}$  = densities of the first and second layers, respectively

$V_1, V_2$  = seismic velocities of the first and second layers, respectively

Modern reflection methods can ordinarily detect isolated interfaces whose reflection coefficients are as small as  $\pm 0.02$ .

a. Reflection principles.

(1) The physical process of reflection is illustrated in Figure 3-28, where the raypaths from the successive layers are shown. As in Figure 3-28, there are commonly several layers beneath the earth's surface which contribute reflections to a single seismogram. Thus, seismic reflection data are more complex than refraction data because it is these later arrivals that yield information about the deeper layers. At later times in the record, more noise is present thus making the reflections difficult to extract from the unprocessed record.

(2) Figure 3-29 indicates the paths of arrivals that would be recorded on a multichannel seismograph. Note that Figure 3-29 indicates that the subsurface coverage is exactly one half of the surface distance across the geophone spread. The subsurface sampling interval is one half of the distance between geophones on the surface.

(3) Another important feature of modern reflection-data acquisition is illustrated by Figure 3-30. If multiple shots, S1 and S2, are recorded by multiple receivers, R1 and R2, and the geometry is as shown in the figure, the reflector point for both rays is the same. However, the raypaths are not the same length, thus the reflection will occur at different times on the two traces. This time delay, whose magnitude is indicative of the subsurface velocities, is called normal-moveout. With an appropriate time shift, called the normal-moveout correction, the two traces (S1 to R2 and S2 to R1) can be summed, greatly enhancing the reflected energy and canceling spurious noise.

(a) This method is called the common reflection point, common midpoint, or common depth point (CDP) method. If all receiver locations are used as shot points, the multiplicity of data on one subsurface point (called CDP fold) is equal to one half of the number of recording channels. Thus, a 24-channel seismograph will record 12-fold data if a shot corresponding to every receiver position is shot into a full spread. Thus, for 12-fold data every subsurface point will have 12 separate traces added, after appropriate time shifting, to represent that point.

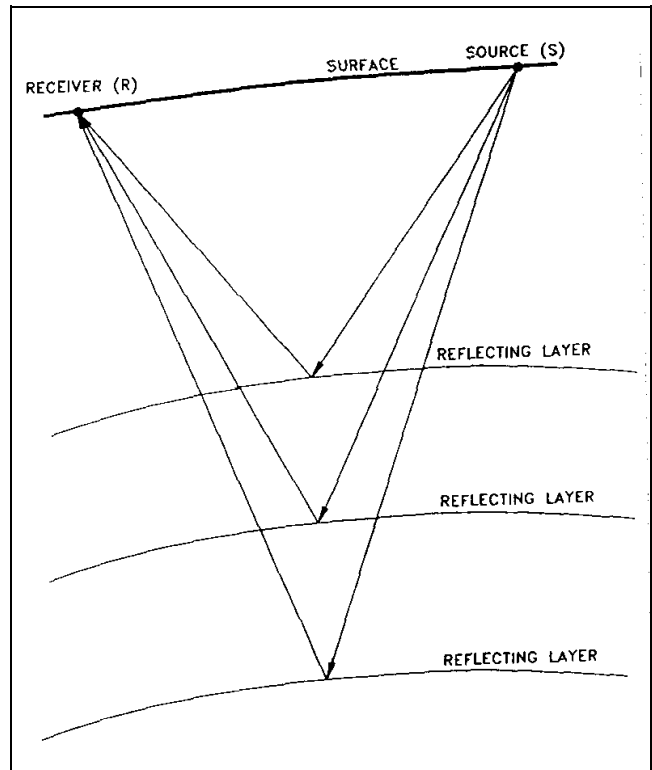

Figure 3-28. Schematic of seismic reflection method

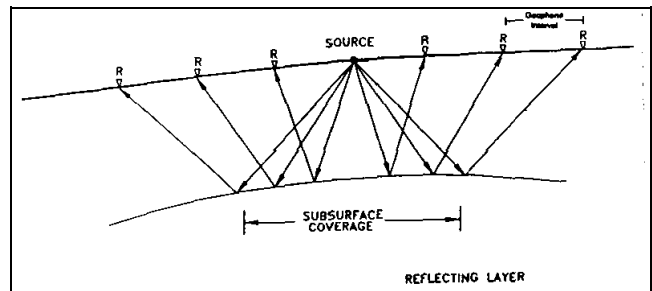

Figure 3-29. Multi-channel recordings for seismic reflection

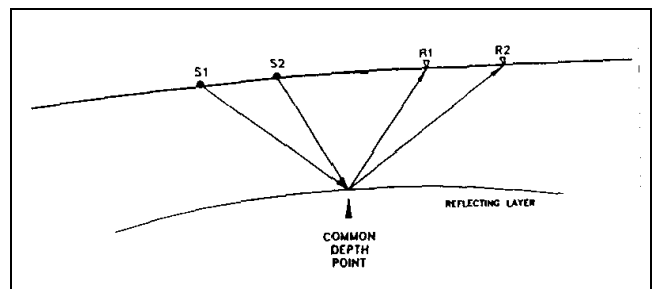

Figure 3-30. Illustration of common-depth point recording



(b) Arrivals on a seismic reflection record can be seen in Figure 3-31. The receivers are arranged to one side of a shot which is 15 m from the first geophone. Various arrivals are identified on Figure 3-31. Note that the gain is increased down the trace to maintain the signals at about the same size by a process known as automatic gain control (AGC). One side of the traces is shaded to enhance the continuity between traces.

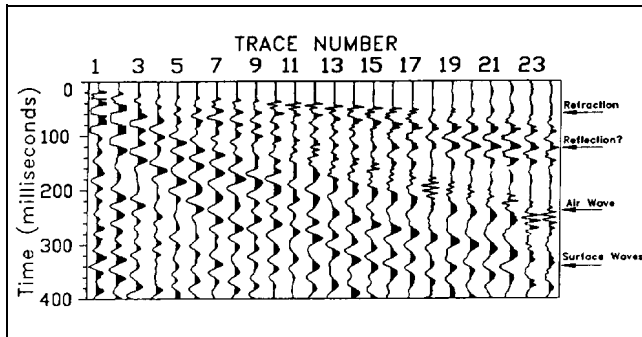

Figure 3-31. Sample seismic reflection record

(4) The ultimate product of a seismic reflection job is a corrected cross section with reflection events in their true subsurface positions. Though more than 60 years of development have gone into the seismic reflection method in the search for petroleum, the use of reflection for the shallow subsurface (less than 50 m) remains an art. This manual cannot give every detail of the acquisition and processing of shallow seismic reflection data. Thus the difference between deep petroleum-oriented reflection and shallow reflection work suitable for engineering and environmental applications will be stressed.

(5) Cost and frequency bandwidth are the principal differences between the two applications of seismic reflection. One measure of the nominal frequency content of a pulse is the inverse of the time between successive peaks. In the shallow subsurface the exploration objectives are often at depths of 15 to 45 m. At 450 m/s, a wave with 10 ms peak to peak (nominal frequency of 100 Hz) is 45 m long. To detect (much less differentiate between) shallow, closely spaced layers, pulses with nominal frequencies at or above 200 Hz may be required. A value of 1,500 m/s is used as a representative velocity corresponding to saturated, unconsolidated materials because without saturated sediments, both attenuation and lateral variability make reflection generally difficult.

*b. Common offset reflection methods.* A technique for obtaining onefold reflection data is called the common-offset method or common-offset gather (COG). It is

instructive to review the method, but it has fallen into disuse because of the decreased cost of CDP surveys and the difficulty of quantitative interpretation in most cases.

(1) Figure 3-32 illustrates time-distance curves for the seismic waves which can be recorded. In the optimum offset distance range, the reflected and refracted arrivals will be isolated in time. Note that no quantitative scales are shown as the distances, velocities, and wave modes are distinct at each site. Thus testing is necessary to establish the existence and location of the optimum offset window.

(2) Figure 3-33 illustrates the COG method. After the optimum offset distance is selected, the source and receiver are moved across the surface. Note that the subsurface coverage is one-fold and there is no provision for noise cancellation. Figure 3-34 is a set of data presented as common offset data. The offset between geophone and shot is 14 m (45 ft). Note that the acoustic wave (visible as an arrival near 40 ms) is attenuated (the shot was buried for this record). Note the prominent reflection near 225 ms that splits into two arrivals near line distance 610 m. Such qualitative changes are the usual interpretative result of a common offset survey. No depth scale is furnished.

*c. Field techniques.* A shallow seismic reflection crew consists of three to five persons. The equipment used allows two to three times the number of active receivers to be distributed along the line. A switch (called a roll-along switch) allows the seismograph operator to select the particular set of geophones required for a particular shot from a much larger set of geophones that have been previously laid out. The operator can then switch the active array down the line as the position of the shot progresses. Often the time for a repeat cycle of the source and the archiving time of the seismograph are the determining factors in the production rates. With enough equipment, one or two persons can be continually moving equipment forward on the line while a shooter and an observer are sequencing through the available equipment.

(1) If the requirements for relative and absolute surveying are taken care of at a separate time, excellent production rates, in terms of number of shotpoints per day, can be achieved. Rates of 1/min or 400-500/normal field day can be achieved. Note that the spacing of these shot points may be only 0.6 to 1.2 m, so the linear progress may be only about 300 m of line for very shallow surveys. Also note that the amount of data acquired is

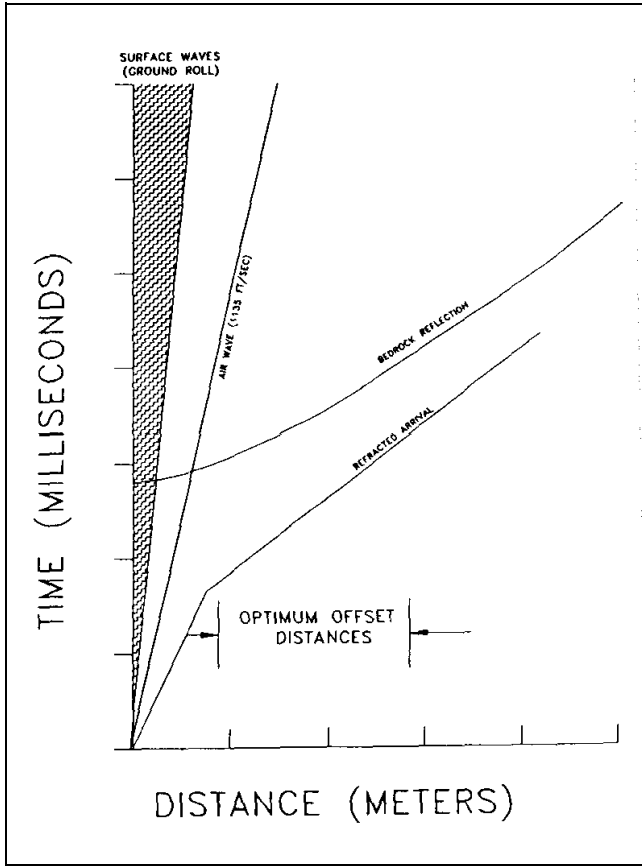

Figure 3-32. Optimum offset distance determination for the common-offset method

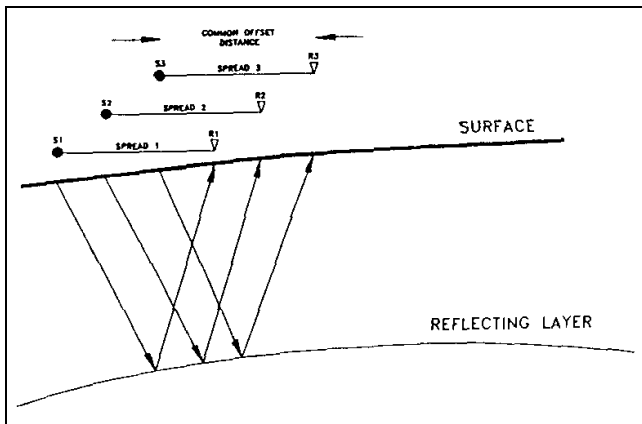

Figure 3-33. Common-offset method schematic

enormous. A 24-channel record sampled every 1/8 ms that is 200 ms long consists of nearly 60,000 thirty-two-bit numbers or upwards of 240 KB/record. Three hundred records may represent more than 75 MB of data for 1 day of shooting.

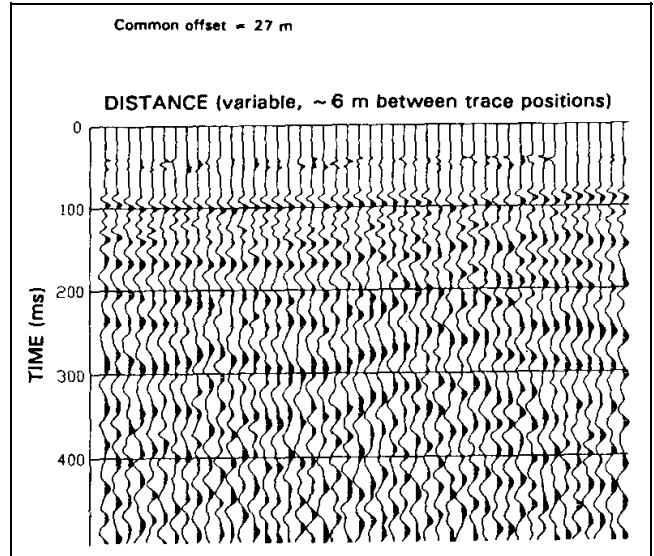

Figure 3-34. Sample common-offset record

(2) Field data acquisition parameters are highly site specific. Up to a full day of testing with a knowledgeable consultant experienced in shallow seismic work may be required. The objective of these tests is identifiable, demonstrable reflections on the raw records. If arrivals consistent with reflections from the zone of interest cannot be seen, the chances that processing will recover useful data are slim.

(3) One useful testing technique is the walkaway noise test. A closely spaced set of receivers is set out with a geophone interval equal to 1 or 2 percent of the depth of interest - often as little as 30 or 60 cm for engineering applications. By firing shots at different distances from this spread, a well-sampled long-offset spread can be generated. Variables can include geophone arrays, shot patterns, high and low-cut filters, and AGC windows, among others.

(4) Because one objective is to preserve frequency content, Table 3-2 is offered as a comparison between petroleum-oriented and engineering-oriented data acquisition. The remarks column indicates the reason for the differences.

*d. Processing.* Processing is typically done by professionals using special purpose computers. These techniques are expensive but technically robust and excellent results can be achieved. Exposition of all the processing variables is well beyond the scope of this manual. However a close association of the geophysicist, the processor,

**Table 3-2**  
**Seismic Reflection Use Differences by Methodology**

	Petroleum	Engineering	Remarks
Explosive seismic source	10-25 kg or more in a distributed pattern in deep holes	20 to 50 g, single shot	To increase frequency content
Mechanical seismic source	1-7 vibrators 5-15,000 kg peak force 10-100 Hz sweep	Hammer and Plats, guns <sup>1</sup>	Cost, increased frequency
Geophones	Arrays of 12-48 phones; 25-40 Hz fundamental frequency; 3-20 m spacing	Single or 3-5 geophones 50-100 Hz fundamental frequency; 1-3 m spacing	To preserve frequency content
Recorders	Instantaneous floating point, 48-1,000 channels	Instantaneous floating point, 24-96 channels	Cost
Passband analog filters	10-110 Hz	100-500 Hz	To increase frequency content
Sample interval	1-2 ms	1/4-1/8 ms	Higher frequencies

<sup>1</sup> High-frequency vibrators are becoming available in 1994.

and the consumer is absolutely essential if the results are to be useful. Well logs, known depths, results from ancillary methods, and the expected results should be furnished to the processor. At least one iteration of the results should be used to ensure that the final outcome is successful.

(1) One important conclusion of the processing is a true depth section. The production of depth sections requires conversion of the times of the reflections to depths by derivation of a velocity profile. Well logs and check shots are often necessary to confirm the accuracy of this conversion.

(2) These warnings are important because powerful processing algorithms can produce very appealing but erroneous results. Most data processors are oriented to petroleum exploration and volume production. The effort and cooperation required by both the geophysicist and the processor are beyond that normal in exploration scenarios.

*e. General conclusions-seismic reflection.*

(1) It is possible to obtain seismic reflections from very shallow depths, perhaps as shallow as 3 to 5 m.

(2) Variations in field techniques are required depending on depth.

(3) Containment of the air-blast is essential in shallow reflection work.

(4) Success is greatly increased if shots and phones are near or in the saturated zone.

(5) Severe low-cut filters and arrays of a small number (1-5) of geophones are required.

(6) Generally, reflections should be visible on the field records after all recording parameters are optimized.

(7) Data processing should be guided by the appearance of the field records and extreme care should be used not to stack refractions or other unwanted artifacts as reflections.

**3-4. Surface Wave Methods**

*a. Rayleigh wave methods.* A wide variety of seismic waves propagate along the surface of the earth. They are called surface waves because their amplitude decreases exponentially with increasing depth. The Rayleigh wave is important in engineering studies because of its simplicity and because of the close relationship of its velocity to the shear-wave velocity for earth materials. As most earth materials have Poisson's ratios in the range of 0.25 to 0.48, the approximation of Rayleigh wave velocities as shear-wave velocities causes less than a 10-percent error.

(1) Rayleigh wave studies for engineering purposes have most often been made in the past by direct observation of the Rayleigh wave velocities. One method consists of excitation of a monochromatic wave train and the direct observation of the travel time of this wave train between two points. As the frequency is known, the wavelength is determined by dividing the velocity by the frequency.

(2) The assumption that the depth of investigation is equal to one-half of the wavelength can be used to generate a velocity profile with depth. This last assumption is somewhat supported by surface wave theory, but more modern and comprehensive methods are available for inversion of Rayleigh-wave observations. Similar data can be obtained from impulsive sources if the recording is made at sufficient distance such that the surface wave-train has separated into its separate frequency components.

*b. Spectral analysis of surface waves (SASW).* The promise, both theoretical and observational, of surface wave methods has resulted in significant applications of technology to their exploitation. The problem is twofold:

(1) To determine, as a function of frequency, the velocity of surface waves traveling along the surface (this curve, often presented as wavelength versus phase velocity, is called a dispersion curve).

(2) From the dispersion curve, determine an earth structure that would exhibit such dispersion. This inversion, which is ordinarily done by forward modeling, has been automated with varying degrees of success.

*c. Measurement of phase velocity.* Spectral analysis, via the Fourier transform, can break down any time-domain function into its constituent frequencies. Cross-spectral analysis yields two valuable outputs from the simultaneous spectral analysis of two time functions. One output is the phase difference between the two time functions as a function of frequency. This phase difference spectrum can be converted to a time difference (as a function of frequency) by use of the relationship:

$$\Delta t(f) = \Phi(f)/2\pi f$$

where

$\Delta t(f)$  = frequency-dependent time difference

$\Phi(f)$  = cross-spectral phase at frequency  $f$

$f$  = frequency to which the time difference applies

(1) If the two time functions analyzed are the seismic signals recorded at two geophones a distance  $d$  apart, then the velocity, as a function of frequency, is given by:

$$V(f) = d/t(f)$$

where

$d$  = distance between geophones

$t(f)$  = term determined from the cross-spectral phase

If the wavelength ( $\lambda$ ) is required, it is given by

$$\lambda(f) = V(f)/f$$

(2) As these mathematical operations are carried out for a variety of frequencies, an extensive dispersion curve is generated. The second output of the cross-spectral analysis that is useful in this work is the coherence function. This output measures the similarity of the two inputs as a function of frequency. Normalized to lie between 0 and 1, a coherency of greater than 0.9 is often required for effective phase difference estimates.

(a) Once the dispersion curve is in hand, the calculation-intensive inversion process can proceed. While the assumption given above of depth equal to one half the wavelength may be adequate if relatively few data are available, the direct calculation of a sample dispersion curve from a layered model is necessary to account for the abundance of data that can be recorded by a modern seismic system. Whether or not the inversion is automated, the requirements for a good geophysical inversion should be followed and more observations than parameters should be selected.

(b) Calculation methods for the inversion are beyond the scope of this manual. The model used is a set of flat-lying layers made up of thicknesses and shear-wave velocities. More layers are typically used than are suspected to be present and one useful iteration is to consolidate the model layers into a geologically consistent model and repeat the inversion for the velocities only.

(3) The advantages of this method are:

(a) High frequencies (1-300 Hz) can be used, resulting in definition of very thin layers.

(b) The refraction requirement of increasing velocities with depth is not present; thus, velocities which decrease with depth are detectable.

By using both of these advantages, this method has been used to investigate pavement substrate strength. An example of typical data obtained by an SASW experiment is shown in Figure 3-35. The scatter of these data is smaller than typical SASW data. Models obtained by two different inversion schemes are shown in Figure 3-36

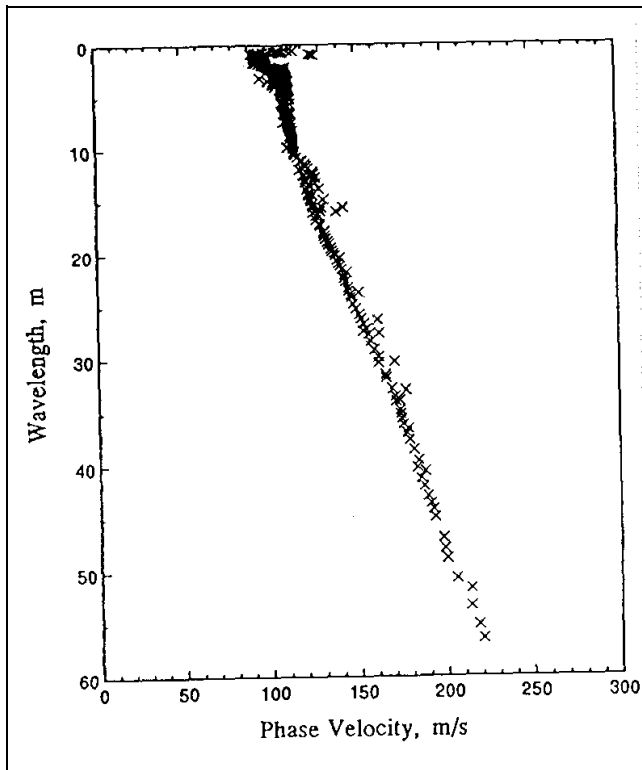

Figure 3-35. Typical SASW data

along with some crosshole data for comparison. Note that the agreement is excellent above 20 m of depth.

*d. Field work.* To date (1994) no commercial SASW equipment has been offered for sale. Most crews are equipped with a two- or four-channel spectrum analyzer, which provides the cross-spectral phase and coherence information. The degree of automation of the subsequent processing varies widely from laborious manual entry of the phase velocities into an analysis program to automated acquisition and preliminary processing. The inversion process similarly can be based on forward modeling with lots of human interaction or true inversion by computer after some manual smoothing.

(1) A typical SASW crew consists of two persons, one to operate and coordinate the source and one to monitor the quality of the results. Typical field procedures are to place two (or four) geophones or accelerometers close together and to turn on the source. The source may be any mechanical source of high-frequency energy; moving bulldozers, dirt whackers, hammer blows, and vibrators have been used. Some discretion is advised as the source must operate for long periods of time and the physics of what is happening are important. Rayleigh waves have

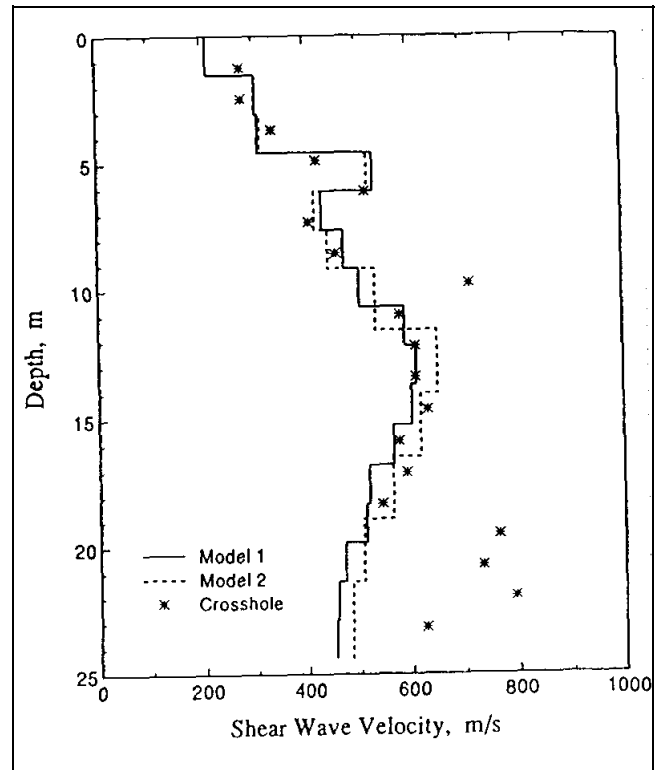

Figure 3-36. Inversion results of typical SASW data

predominantly vertical motion; thus, a source whose impedance is matched to the soil and whose energy is concentrated in the direction and frequency band of interest will be more successful.

(2) Phase velocities are determined for waves with wavelength from 0.5 to 3 times the distance between the geophones. Then the phones are moved apart, usually increasing the separation by a factor of two. Thus, overlapping data are acquired and the validity of the process is checked. This process continues until the wavelength being measured is equal to the required depth of investigation. Then the apparatus is moved to the next station where a sounding is required. After processing, a vertical profile of the shear-wave velocities is produced.

*e. Pitfalls.*

(1) The assumption of plane layers from the source to the recording point may not be accurate.

(2) Higher modes of the Rayleigh wave may be recorded. The usual processing assumption is that the fundamental mode has been measured.

(3) Spreading the geophones across a lateral inhomogeneity will produce complications beyond the scope of the method.

(4) Very high frequencies may be difficult to generate and record.

### 3-5. Subbottom Profiling

A variant of seismic reflection used at the surface of water bodies is subbottom profiling or imaging. The advantage of this technique is the ability to tow the seismic source on a "sled" or catamaran and to tow the line of hydrophones. This procedure makes rapid, continuous reflection soundings of the units below the bottom of the water body, in other words, the "subbottom." This method and significant processing requirements have been recently developed by Ballard et al. (1993) of the U.S. Army Engineer Waterways Experiment Station (WES). The equipment, acquisition, and processing system reduce the need for overwater boring programs. The developed WES imaging procedure resolves "material type, density, and thickness" (Ballard et al. 1993).

*a. Theory and use.* The acoustic impedance method may be exploited with other forms of Equations 3-2 and 3-14 to determine parameters of the soft aqueous materials. The acoustic impedance  $z$  for a unit is the product of its  $\rho_b$  and  $V_p$ . The reflection coefficient  $R$  from a particular horizon is

$$R = (E_{refl}/E_{inc})^{1/2} = [(z_i - z_j)/(z_i + z_j)] \quad (3-15)$$

where

$E_{refl}$  = energy reflected at the i-j unit boundary

$E_{inc}$  = incident energy at the i-j unit boundary

$z_i$  = acoustic impedance of the i (lower) material

$z_j$  = acoustic impedance of the j (upper) medium

At the highest boundary, the water-bottom interface,  $z_{j,water}$  is known to be  $1.5 \times 10^9$  g/(m<sup>2</sup>s). Since the  $E_{refl,1-2}$  can be determined and  $E_{inc,1-2}$  and  $z_{1,water}$  are known,  $z_{i,2}$  may be determined.  $V_{p,2}$  may be assessed from the depth of the 2-3 boundary and thus  $\rho_{i,2}$  may be resolved. The material properties of lower units can be found in succession from the reflections of deeper layers.

(1) A variety of different strength sources are available for waterborne use. By increasing strength, these

sources are: pingers, boomers, sparkers, and airguns. While there is some strength overlap among these sources, in general, as energy increases, the wave's dominant period increases. For the larger source strength, therefore, the ability to resolve detail is impaired as period and wavelength become larger. The resolving accuracy of the system may change by more than an order of magnitude from <0.2 m for a pinger to >1.0 m for an airgun.

(a) The WES Subbottoming System has two sources: a 3.5- and 7.0-kHz pinger and a 0.5- to 2.5-kHz broad spectrum boomer. The pinger can attain resolutions to 0.2 m, while the boomer has a resolution on the order of 1/2 m.

(b) The conflicting impact of energy sources is the energy available for penetration and deeper reflections. The boomer's greater energy content and broad spectrum allow significantly greater depth returns. Some near-bottom sediments contain organic material that readily absorbs energy. Higher energy sources may allow penetration of these materials.

(2) Data collection is enormous with a towed subbottoming system. Graphic displays print real-time reflector returns to the hydrophone set. Recording systems retrieve the data for later processing. The field recorders graph time of source firing versus time of arrival returns. Figure 3-37 provides the field print for Oakland Harbor (Ballard, McGee, and Whalin 1992).

(a) Office processing of the field data determines the subbottoming properties empirically. The empiricisms are reduced when more sampling (boring) data are available to assess unit  $\rho$  and loss parameters for modeling. The processing imposes the Global Positioning System (GPS) locations upon the time of firing records to approximately locate the individual "shot" along the towed boat path. The seismic evaluation resolves the layer  $V_p$  and unit depths. From the firing surface locations and unit depths, the field graphs are correlated to tow path distance versus reflector depths. Figure 3-38 shows cross sections of the Gulfport Ship Channel, Mississippi. These are fence diagrams of depth and material types once all parallel and crossing surveys are resolved.

(b) WES processing capabilities now allow 3-dimensional surfaces to be mathematically appraised from the fence diagrams. These computer volumetric depictions are convenient for visualizing the subsurface deposition. More importantly, direct volume estimates and project development can be created.

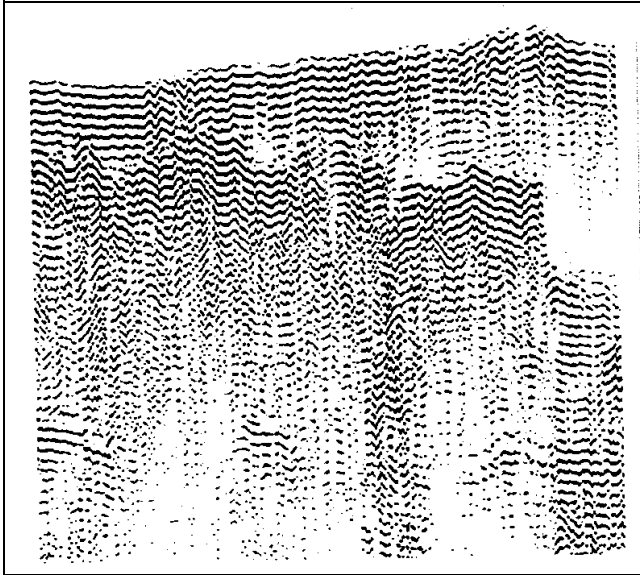

Figure 3-37. Reflected subbottoming signal amplitude cross section-3.5 kHz in Oakland Harbor, California (Ballard, McGee, and Whalin 1992)

*b. Availability.* Research at the U.S. Army Engineer Waterways Experiment Station (WES) has developed oil exploration techniques for engineering projects.

(1) The original research interest was dredging material properties. The current system has been combined with GPS to locate the continuous ship positions for knowing the source/hydrophone locations.

(2) WES has a Subbottom Imaging System to provide data for engineering projects in coastal, river and lake environments. The WES Subbottoming System is ship-mounted, so that it can be shipped overland to differing marine environments.

(3) The subbottoming technique can be applied to a large variety of water bodies. Saltwater harbors and shipping channels and river waterways were the original objective for the dredging research. The developed system has broad applicability to locks and dams, reservoir projects, and engineering projects such as location of pipelines.

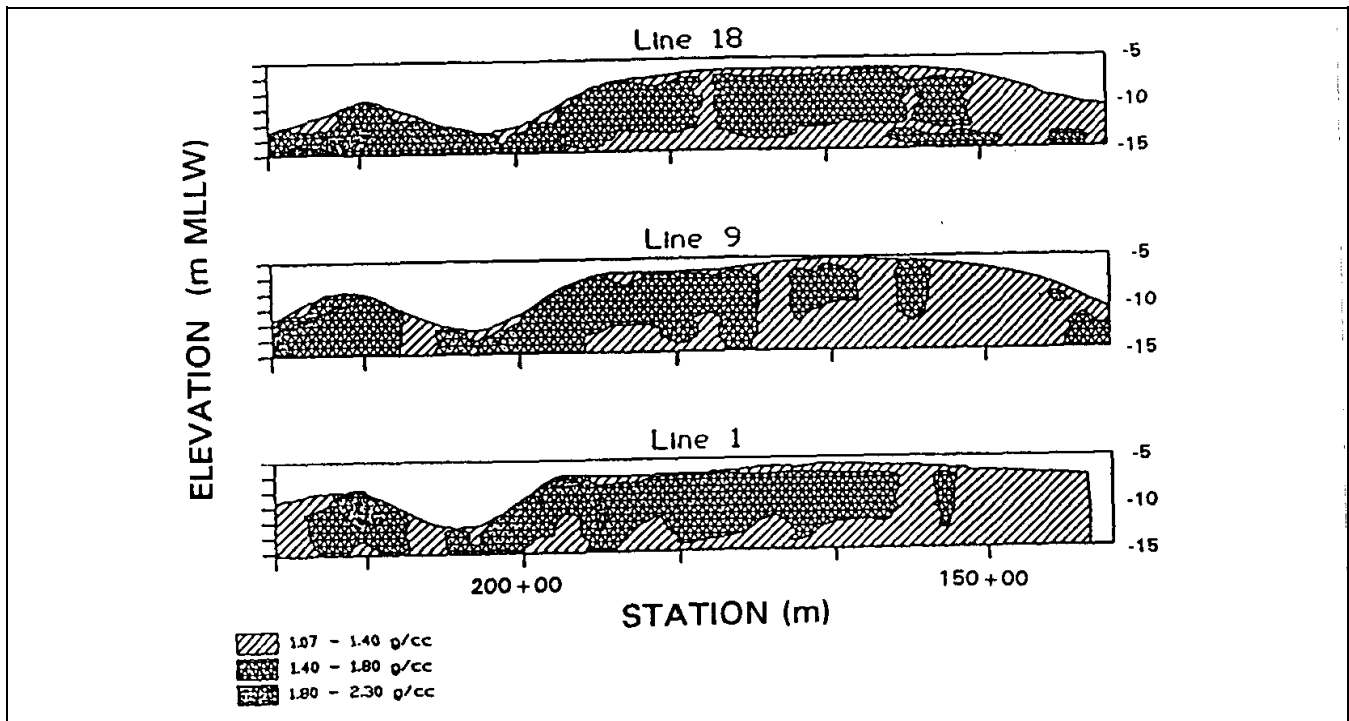

Figure 3-38. Density cross sections in Gulfport Ship Channel, Mississippi (Ballard, McGee, and Whalin 1992)

## Chapter 4 Electrical and Electromagnetic Methods

### 4-1. Introduction

Electrical geophysical prospecting methods detect the surface effects produced by electric current flow in the ground. Using electrical methods, one may measure potentials, currents, and electromagnetic fields which occur naturally or are introduced artificially in the ground. In addition, the measurements can be made in a variety of ways to determine a variety of results. There is a much greater variety of electrical and electromagnetic techniques available than in the other prospecting methods, where only a single field of force or anomalous property is used. Basically, however, it is the enormous variation in electrical resistivity found in different rocks and minerals which makes these techniques possible (Telford et al. 1976).

*a. Electrical properties of rocks.* All materials, including soil and rock, have an intrinsic property, resistivity, that governs the relation between the current density and the gradient of the electrical potential. Variations in the resistivity of earth materials, either vertically or laterally, produce variations in the relations between the applied current and the potential distribution as measured on the surface, and thereby reveal something about the composition, extent, and physical properties of the subsurface materials. The various electrical geophysical techniques distinguish materials through whatever contrast exists in their electrical properties. Materials that differ geologically, such as described in a lithologic log from a drill hole, may or may not differ electrically, and therefore may or may not be distinguished by an electrical resistivity survey. Properties that affect the resistivity of a soil or rock include porosity, water content, composition (clay mineral and metal content), salinity of the pore water, and grain size distribution.

(1) In an electrically conductive body that lends itself to description as a one-dimensional body, such as an ordinary wire, the relationship between the current and potential distribution is described by Ohm's law:

$$V = IR \quad (4-1)$$

where

$V$  = difference of potential between two points on the wire

$I$  = current through the wire

$R$  = resistance measured between the same two points as the difference of potential

The resistance ( $R$ ) of a length of wire is given by

$$R = \rho \frac{L}{A} \quad (4-2)$$

where

$\rho$  = resistivity of the medium composing the wire

$L$  = length

$A$  = area of the conducting cross section

Note that if  $R$  is expressed in ohms ( $\Omega$ ) the resistivity has the dimensions of ohms multiplied by a unit of length. It is commonly expressed in  $\Omega\text{m}$  but may be given in  $\Omega\text{-cm}$  or  $\Omega\text{-ft}$ . The conductivity ( $\sigma$ ) of a material is defined as the reciprocal of its resistivity ( $\rho$ ). Resistivity is thus seen to be an intrinsic property of a material, in the same sense that density and elastic moduli are intrinsic properties.

(2) In most earth materials, the conduction of electric current takes place virtually entirely in the water occupying the pore spaces or joint openings, since most soil- and rock-forming minerals are essentially nonconductive. Clays and a few other minerals, notably magnetite, specular hematite, carbon, pyrite, and other metallic sulfides, may be found in sufficient concentration to contribute measurably to the conductivity of the soil or rock.

(3) Water, in a pure state, is virtually nonconductive but forms a conductive electrolyte with the presence of chemical salts in solution, and the conductivity is proportional to the salinity. The effect of increasing temperature is to increase the conductivity of the electrolyte. When the pore water freezes, there is an increase in resistivity, perhaps by a factor of  $10^4$  or  $10^5$ , depending on the salinity. However, in soil or rock this effect is diminished by the fact that the pore water does not all freeze at the same time, and there is usually some unfrozen water present even at temperatures considerably below freezing. The presence of dissolved salts and the adsorption of water on grain surfaces act to reduce the freezing temperature. Even so, electrical resistivity surveys made on frozen ground are likely to encounter difficulties because of the



high resistivity of the frozen surface layer and high contact resistance at the electrodes. On the other hand, the effect of freezing on resistivity makes the resistivity method very useful in determining the depth of the frozen layer. It is very helpful in the interpretation of such surveys to have comparison data obtained when the ground is unfrozen.

(4) Since the conduction of current in soil and rock is through the electrolyte contained in the pores, resistivity is governed largely by the porosity, or void ratio, of the material and the geometry of the pores. Pore space may be in the form of intergranular voids, joint or fracture openings, and blind pores, such as bubbles or vugs. Only the interconnected pores effectively contribute to conductivity, and the geometry of the interconnections, or the tortuosity of current pathways, further affects it. The resistivity  $\rho$  of a saturated porous material can be expressed as

$$\rho = F\rho_w \quad (4-3)$$

where

$F$  = "formation factor"

$\rho_w$  = resistivity of pore water

The formation factor is a function only of the properties of the porous medium, primarily the porosity and pore geometry. An empirical relation, "Archie's Law," is sometimes used to describe this relationship:

$$F = a\phi^{-m} \quad (4-4)$$

where

$a$  and  $m$  = empirical constants that depend on the geometry of the pores

$\phi$  = porosity of the material

Values of  $a$  in the range of 0.47 to 2.3 can be found in the literature. The value of  $m$  is generally considered to be a function of the kind of cementation present and is reported to vary from 1.3 for completely uncemented soils or sediments to 2.6 for highly cemented rocks, such as dense limestones. Equations 4-3 and 4-4 are not usually useful for quantitative interpretation of data from surface electrical surveys but are offered here to help clarify the role of the pore spaces in controlling resistivity.

(5) Bodies of clay or shale generally have lower resistivity than soils or rocks composed of bulky mineral grains. Although the clay particles themselves are non-conductive when dry, the conductivity of pore water in clays is increased by the desorption of exchangeable cations from the clay particle surfaces.

(6) Table 4-1 shows some typical ranges of resistivity values for manmade materials and natural minerals and rocks, similar to numerous tables found in the literature (van Blaricon 1980; Telford et al. 1976; Keller and Frischknecht 1966). The ranges of values shown are those commonly encountered but do not represent extreme values. It may be inferred from the values listed that the user would expect to find in a typical resistivity survey low resistivities for the soil layers, with underlying bedrock producing higher resistivities. Usually, this will be the case, but the particular conditions of a site may change the resistivity relationships. For example, coarse sand or gravel, if it is dry, may have a resistivity like that of igneous rocks, while a layer of weathered rock may be more conductive than the soil overlying it. In any attempt to interpret resistivities in terms of soil types or lithology, consideration should be given to the various factors that affect resistivity.

**Table 4-1**  
**Typical Electrical Resistivities of Earth Materials**

Material	Resistivity ( $\Omega m$ )
Clay	1-20
Sand, wet to moist	20-200
Shale	1-500
Porous limestone	100-1,000
Dense limestone	1,000-1,000,000
Metamorphic rocks	50-1,000,000
Igneous rocks	100-1,000,000

*b. Classification.*

(1) The number of electrical methods used since the first application around 1830 (Parasnis 1962) is truly large; they include self-potential (SP), telluric currents and magnetotellurics, resistivity, equipotential and mise-à-la-masse, electromagnetic (EM), and induced polarization (IP). Because of the large number of methods, there are many ways of classifying them for discussion. One common method is by the type of energy source involved, that is, natural or artificial. Of the methods listed above, the first two are grouped under natural sources and the rest as artificial. Another classification, which will be used here, is to group by whether the data are measured in the time domain or the frequency domain. Only techniques in

common use today for solving engineering, geotechnical, and environmental problems will be treated in this discussion, thus omitting telluric current techniques, magnetotellurics, and many of the EM methods.

(2) Time domain methods (often abbreviated as TDEM or TEM) are those in which the magnitude only or magnitude and shape of the received signal is measured. The techniques in this class are discussed under the headings DC resistivity, induced polarization, time-domain electromagnetics, and self-potential. Frequency domain methods (often abbreviated as FDEM or FEM) are those in which the frequency content of the received signal is measured. Generally FDEM methods are continuous source methods, and measurements are made while the source is on. The measurement is of magnitude at a given frequency. Techniques in this class are discussed under the headings of VLF, terrain conductivity, and metal detectors.

*c. Resistivity methods versus electromagnetic methods.* Before discussing the individual methods it is useful to outline the main differences between the resistivity (including induced polarization) methods and the electromagnetic methods. With resistivity methods, the source consists of electrical current injected into the ground through two electrodes. The transmitted current wave form may be DC, low frequency sinusoidal (up to about 20 Hz), or rectangular, as in induced polarization surveys with a frequency of about 0.1 Hz. The energizer, therefore, is the electrical current injected into the ground through current electrodes.

(1) With electromagnetic methods, the source most commonly consists of a closed loop of wire in which AC current flows. It can be a small, portable transmitter coil up to 1 m in diameter, in which case there are many turns of wire. Alternately, the source can be a large transmitter loop on the ground, as large as 1 km in diameter. The frequency of the transmitter current can range from about 0.1 to about 10,000 Hz. Instruments commonly used for engineering applications (such as the EM-31, EM-34, and EM-38) use the small, multiturn type of coil and frequencies above 2,500 Hz. Electric current in the transmitter loop generates a magnetic field. The magnetic field is the energizer in electromagnetic methods as compared with electric current in resistivity methods.

(2) In terms of response, with resistivity methods, anomalies result from resistivity contrasts. For example, if a target with a resistivity of 10  $\Omega\text{m}$  is in a host rock

with a resistivity of 100  $\Omega\text{m}$ , the same anomaly results as if the target had a resistivity of 100  $\Omega\text{m}$  in a host rock with a resistivity of 1,000  $\Omega\text{m}$ . In both cases, there is a resistivity contrast of 10. This example holds as long as the transmitter frequency is low enough that there is no appreciable electromagnetic induction in the rocks. With electromagnetic methods, anomalies are due more to absolute resistivity rather than resistivity contrasts. The two examples mentioned previously for resistivity methods would not produce the same anomalies with electromagnetic methods (Klein and Lajoie 1980).

#### 4-2. Self-Potential Method

*a. General.* Various potentials are produced in native ground or within the subsurface altered by our actions. Natural potentials occur about dissimilar materials, near varying concentrations of electrolytic solutions, and due to the flow of fluids. Sulfide ore bodies have been sought by the self potential generated by ore bodies acting as batteries. Other occurrences produce spontaneous potentials, which may be mapped to determine the information about the subsurface. Spontaneous potentials can be produced by mineralization differences, electrochemical action, geothermal activity, and bioelectric generation of vegetation.

(1) Four different electrical potentials are recognized. Electrokinetic, or streaming, potential is due to the flow of a fluid with certain electrical properties passing through a pipe or porous medium with different electrical properties (Figure 4-1). Liquid-junction, or diffusion, potential is caused by the displacement of ionic solutions of dissimilar concentrations. Mineralization, or electrolytic contact, potential is produced at the surface of a conductor with another medium. Nernst, or shale, potential occurs when similar conductors have a solution of differing concentrations about them. Telford, Geldart and Sheriff (1990) provide equations for differing potentials. Generally, the SP method is qualitative and does not attempt to quantify the anomalous volume size, owing to the unknown volumetric shapes, concentration/density of various masses, and electrical properties of the sought causative media.

(2) Recognition of different spontaneous-potential sources is important to eliminate noise, the low background voltages. Some engineering and environmental occurrences may be mapped by contouring surficial voltages between base/reference electrode(s) and the mobile electrodes. Flow of gasses and fluids in pipes, leakage of a reservoir within the foundation or abutment of a dam,

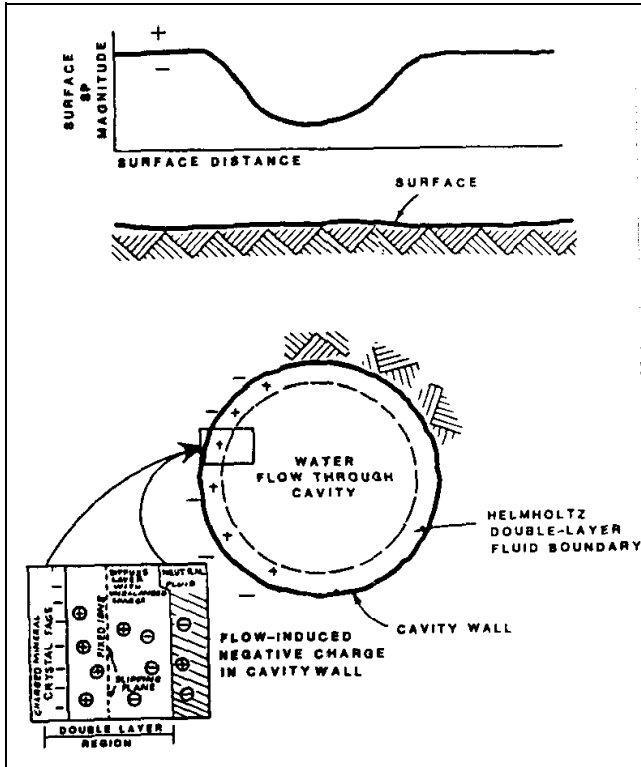

Figure 4-1. Schematic of flow-induced negative streaming potentials (Erchul and Slifer 1989)

movement of ionic fluids to or within the groundwater, flow of geothermal fluids, and movement of water into or through a karst system can be the origin of streaming potentials. These potentials may exceed the background voltage variation of a site.

*b. Equipment and procedures.* A simple SP survey consists of a base electrode position and a roving electrode to determine potential differences on a gridded survey or along profile lines. The required equipment merely includes electrodes, wire and a precise millivolt meter.

(1) Nonpolarizing electrodes. The electrodes in contact with the ground surface should be the nonpolarizing type, also called porous pots. Porous pots are metal electrodes suspended in a supersaturated solution of their own salts (such as a copper electrode suspended in copper sulfate) within a porous container. These pots produce very low electrolytic contact potential, such that the background voltage is as small as possible. Tinker and Rasor manufacture models of porcelain nonpolarizing electrodes that are reliable and sealed to avoid evaporation of the salt solution.

(a) Sealed pots can keep their supersaturated solutions for more than a week, even in arid locales. Refilling of the pots' solution must occur before a day's work due to the possible contact potential change while performing a measurement set. A useful procedure is to mix remaining fluids from pots in a single container, add new solution to the pots' mixture, and use the mixed solution to fill the pots. Then all pots contain the same solution mix.

(b) Multiple pots are purchased such that breakage and cleaning may be accomplished readily in the field. Only one set of a base and mobile electrode are used at any one measurement loop/grid. Base station pots are usually larger in size to assure constant electrical contact through the time of use of that station. Mobile or traveling pots are often smaller in volume of salt solution and size.

(c) Copper-clad steel electrodes are used in a variety of electrical surveys. Steel electrodes should be avoided in SP investigations. Contact potential of these electrodes is quite high and variable in the soil at various stations of the survey.

(2) Survey wire.

(a) The wire used in SP surveys must be strong, hardy, and of low resistance. Wire needs to have sufficient tensile strength to be able to withstand long-term pulls of survey work for multiple sites. For some field use, heavy twine or light rope may need to be twisted and knotted to long lengths of wire to add strength. Survey wire must have abrasion-resistant insulator wrapping. Pulling the wire over roadway surfaces can expose bare wire. Usually random bare wire positions will not fully ground to the soil, and the effects will be variable as differing lengths of wire are unreel and occupy differing positions for the survey. This error will only modify the signal by a few to tens of millivolts (mV). Twisted two-conductor, 18-gauge, multistrand (not solid conductor) copper wire has been found to be strong and abrasion resistant.

(b) Resistance will be constant for survey wire between stations, if the wire for a reading set is not permanently stretched in length, does not develop insulator leaks and is not repaired. Repairs to wire should be made when needed because of bare wire or severe plastic stretching of the wire. Repairs and addition of wire to lengthen the survey use should only be made between measurement loops/grids. No changes to the wire may be

made during a loop or grid of readings without reoccupation of those positions. Wire accidentally severed requires a remeasurement of that complete set of circuit stations.

(3) Millivolt meter.

(a) An inexpensive, high-input-impedance voltmeter is used to read the potential in the millivolt range. Actual field voltage will be in error when the source potential is within an order of magnitude of the meter's input impedance. The meter uses a bias current to measure the desired potential. The input impedance should exceed 50 M $\Omega$ . Higher input impedances are desirable due to the impedance reduction of air's moisture. The resolution of the meter should be 0.1 or 1.0 mV.

(b) Several useful options on meters are available. Digital voltmeters are more easily read. Water-resistant or sealed meters are extremely beneficial in field use. Notch filters about 60 Hz will reduce stray alternating current (AC) potentials in industrial areas or near power lines.

*b. Field deployment.* Background potentials for these surveys may be at a level of a few tens of millivolts. Source self-potentials must exceed the background to be apparent. Potentials exceeding 1.0 V have occurred for shallow or downhole measurements of large sources. When large potentials are expected or have been found at the site with nonpolarizing electrodes, the easier to use copper-clad steel electrodes have been substituted for porous pots, but steel electrodes are not recommended. Contact potentials of the steel electrodes and reversing electrode positions are required systematically for steel electrodes. Large errors may develop from the use of steel electrodes (Corwin 1989).

(1) Measurements with the electrodes may require a system of reversing the electrode position to resolve contact potentials at the electrodes. Previously measured locations may need to be remeasured on a systematic or periodic basis. Reoccupation of stations is necessary when very accurate surveys are being conducted and for sites with temporal potential changes or spatial variations of electrode potential.

(2) Changes temporally in the electrodes or due to the field's self potential require the survey to be conducted in a gridded or loop array. Loops should have closure voltages of zero or only a few milli-volts. High closure potential requires remeasuring several to all of the loop stations. Station reoccupation should be in the same exact position of the earlier reading(s). Unclosed lines

should be avoided. Reoccupation of particular station intervals should be made when closed loops are not possible.

(a) The traveling electrode should periodically remeasure the base location to observe contact potential, dirty electrodes, or other system changes. Reversing the survey electrodes or changing the wire polarity should only change the voltage polarity.

(b) Electrodes may have contact differences due to varying soil types, chemical variations, or soil moisture. Temporal and temperature variations are also possible, which may require the reoccupation of some of the survey positions on some arranged loop configuration. Electrode potentials have minor shifts with temperature changes (Ewing 1939).

(c) Variation in the flow of fluid due to rainfall, reservoir elevation changes, channelization of flow, or change of surface elevation where measurements are obtained are sources of variation of streaming potential. Self potentials may have temporal or spatial changes due to thunderstorm cloud passage, dissemination of mineralization or electrolytic concentration, and in the groundwater flow conduits and location. High telluric potential variations may require the SP survey to be delayed for a day.

(3) Some simple procedures are required to perform accurate and precise SP surveys. Good maintenance of porous pots, wires, and voltmeters must be observed through the survey.

(a) The traveling pot needs to be kept clean of soil with each position. Contact with moist soil, or more elaborate measures for good electrical contact with roadways or rock, must be assured. A water vessel or "skin" may be carried to moisten the soil hole and clean the porcelain surface.

(b) Wire reels speed the pulling of cable and wire recovery for changing loops, and lessen wear on the cable. Reversing the wire polarity for some measurements and reoccupation of adjacent stations assures the cable has not been grounded or stripped. Repair and checking of the wire must be made between loops and is easily done when rewinding the cable reel.

(c) Quality assurance in the field is conducted by reoccupation of loop closure points with the same base position. Repeated and reversed readings of particular

loop-end stations and checking base locations provide statistics for the assessment of measurement quality.

(4) Grid surveys offer some advantages in planning SP surveys. Changes in elevation (changing the distance to the potential source) and cognizance of cultural effects can be minimized with planning survey grids or loops. AC power lines, metal fences, and underground utilities are cultural features that affect the potential field extraneous to the normal sources of interest.

*c. Interpretation.* Most SP investigations use a qualitative evaluation of the profile amplitudes or grid contours to evaluate self- and streaming-potential anomalies. Flow sources produce potentials in the direction of flow: fluid inflow produces negative relative potentials, as would greater distance from the flow tube; outflow of the fluid results in positive potentials.

(1) Quantitative interpretations for a dam embankment with possible underseepage would be determined from the profiles across the crest. Negative anomalies may be indicative of flow from the reservoir at some depth. The width of the half-amplitude provides a depth estimate. Outflow at the toe of an embankment or at shallow depths beneath the toe would produce positive, narrow anomalies. Mineral or cultural utilities produce varying surface potentials depending on the source.

(2) Semiquantitative, forward solutions may be estimated by equations or programs (Corwin 1989, Wilt and Butler 1990) for sphere, line, and plate potential configurations. These solutions of potential configurations aid in evaluation of the corrected field readings, but are solutions of the data set taken.

*d. Sample field surveys.*

(1) Geothermal use of the SP method is documented in Corwin and Hoover (1979). Erchul and Slifer (1989) provide the included example for karst surveys. The leakage of water from a reservoir (Butler et al. 1989, Llopis and Butler 1988) through an abutment and the movement of rainfall into and through a karst system produce streaming potentials. High reservoir leakage through rock or soil forms the greatest streaming potential when confined flow conduits develop instead of diffuse flow through pore space. SP surveys have been recommended for grouting location, split spacing and effectiveness.<sup>1</sup> The self-potential due to water flow is a direct

<sup>1</sup> Personal Communication, September 1992, David G. Taylor, Strata Services, St. Charles, MO.

parameter for the grouting remediation of reservoir leakage.

(2) SP methods can be very useful for karst groundwater regimes in quick surveys of a site or in long-term surveys during a rainy season. Sinkholes can be pathways of surface water flow. The subsurface flow in karst can be erratic. Figure 4-2 shows the ability of an SP survey to resolve groundwater flow. Note the grid approach used in the survey for this site. There can be a qualitative evaluation of the flow volume in different subsurface routes if the ground surface may be assumed parallel to the surface through the irregular flow paths.

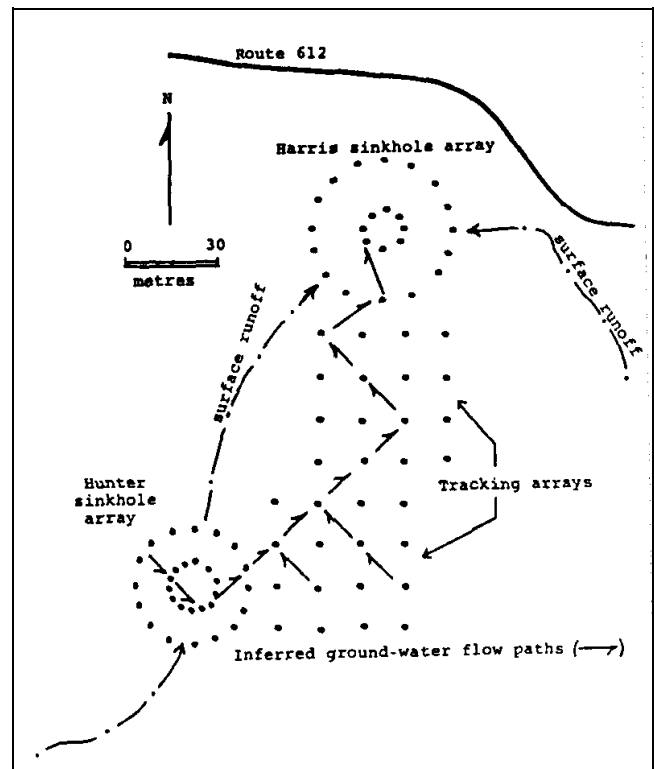

Figure 4-2. Electrode configurations at the Harris-Hunter sinkhole site, showing groundwater flowpaths inferred by SP anomalies (Erchul and Slifer 1989)

### 4-3. Equipotential and Mise-a-la-masse Methods

*a. Introduction.*

(1) According to Parasnis (1973), the equipotential method was one of the first electrical methods and was used as far back as 1912 by Schlumberger. As explained elsewhere in this volume, when electric energy is applied to two points at the ground surface, an electric current will flow between them because of their difference in

potential. If the medium between the two electrodes is homogeneous, the current and potential distribution is regular and may be calculated. When good or poor conductors are imbedded in this homogeneous medium, a distortion of the electrical field occurs. Good conductors have a tendency to attract the current lines toward them while poor conductors force current flow away. Theoretically, it should be possible to detect bodies of different conductivity by measuring the geometric pattern of these current lines. In practice this cannot be done with sufficient accuracy; it is necessary to determine the direction in which no current flows by locating points which have no potential difference (Heiland 1940). The lines of identical potential, called "equipotential lines," are at right angles to the current lines. The equipotentials are circles in the immediate vicinity of the electrodes.

(2) In the past, equipotentials were traced individually in the field by using a null galvanometer, but such a procedure was tedious and time-consuming. The modern practice is to measure the electric voltage at each observation point with respect to a fixed point, plot the results, and draw contours. The equipotential method was used extensively in the early days of geophysics, but has been

almost completely replaced by modern resistivity and electromagnetic methods. When the method is used, it is usually in a reconnaissance mode and quantitative interpretation of equipotential surveys is rarely attempted.

*b. Mise-a-la-masse.* One variant of the method, called mise-a-la-masse, is still used in mining exploration and occasionally in geotechnical applications. The name, which may be translated as "excitation of the mass," describes an electrode array which uses the conductive mass under investigation as one of the current electrodes. In mining, the conductive mass is a mineral body exposed in a pit or drill hole. In geotechnical applications the object under investigation might be one end of an abandoned metal waste pipe. The second current electrode is placed a large distance away. "Large" usually means five or ten times the size of the mass being investigated. The potential distribution from these two current electrodes will, to some extent, reflect the geometry of the conductive mass and would be expected to yield some information concerning the shape and extent of the body. The left-hand part of Figure 4-3 (Parasnis 1973) shows the equipotentials around a subsurface point electrode in a homogeneous isotropic earth. The right-hand part shows

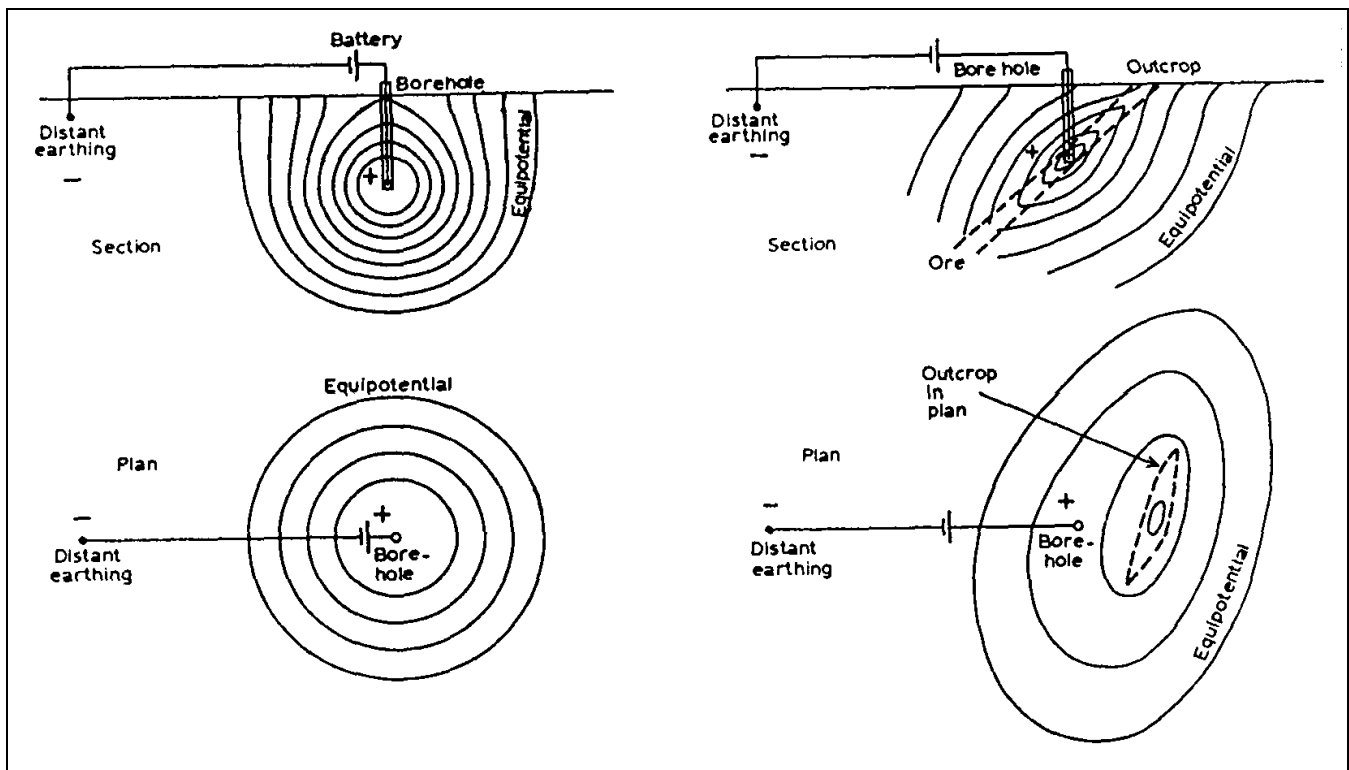

Figure 4-3. Principle of the mise-a-la-masse method. Right side of figure shows the distortion of the equipotential lines due to a conductive ore body (Parasnis 1973; copyright permission granted by Elsevier Science)

(schematically) the distribution of potentials such as might be expected when the point current electrode is placed in a conducting body situated in an otherwise homogeneous earth of lesser conductivity. In this case, the equipotentials tend to follow the ore body and on the ground surface the centroid of the equipotential map does not coincide with the point on the ground vertically above the electrode in the borehole.

(1) Example 1 - buried ammunition magazine. While classic equipotential surveys have all but been replaced by the *mise-a-la-masse* variant, there are occasions when passing an electric current directly through the mass under investigation might be ill-advised. Such a case is shown in Figure 4-4, in which Heiland (1940) shows the results of a classic equipotential survey over an abandoned ammunition magazine. Distortion of the equipotential lines clearly outlines the magazine, and shows that expensive and/or sophisticated techniques are not always necessary.

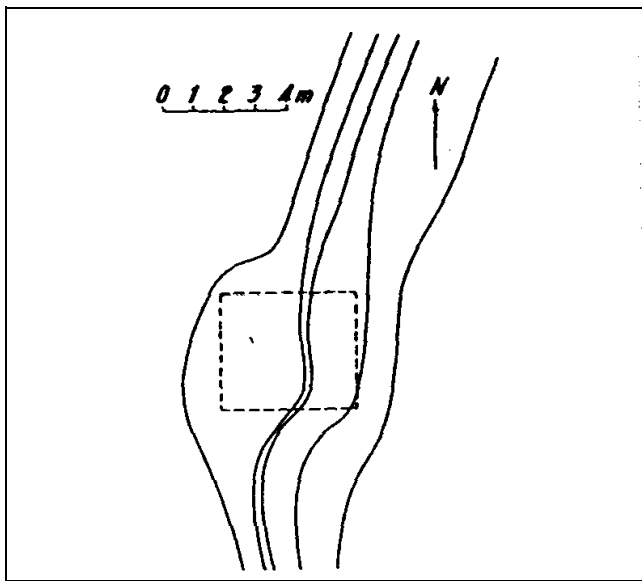

Figure 4-4. Location of a buried ammunition magazine by equipotential methods (Heiland 1940)

(2) Example 2 - advance of groundwater from an infiltration pit. Only one example of *mise-a-la-masse* used for groundwater investigations was found in the literature. Cahyna, Mazac, and Vendhodova (1990) claim *mise-a-la-masse* survey was successfully used to determine the prevailing direction of groundwater leaving an infiltration pit, but unfortunately no figures are included.

(3) Example 3 - partially exposed buried conductors. The need sometimes arises in hazardous-waste site

restoration to trace the extent of buried metal objects such as pipes, cables, and tanks. Often electromagnetic and/or magnetic methods are used to trace these objects, but a special opportunity arises for surveying by *mise-a-la-masse* when part of the object under investigation has been partially exposed at the surface or in a drill hole. Although no geotechnical examples were found in the literature, one of the numerous mining examples will be used, as the results should be similar. Hallof (1980) shows the results of a *mise-a-la-masse* survey at York Harbour, Newfoundland, where sulfides were exposed in underground workings. The objective was to find where the ore most closely approached the surface and if the H-1 zone and the H-2 zone were the lower portions of a single zone near the surface. Figure 4-5 shows the equipotential pattern for the near current electrode located at depth but NOT in one of the ore zones. The pattern is nearly circular and its center is immediately above the current electrode at depth. This was not the case when the current electrode was placed first in the H-1 zone (Figure 4-6) and then in the H-2 zone (not shown). In both cases the center of the surface potential distribution is considerably to the east of the underground position of the mineralization. Further, since almost exactly the same potential distribution was measured for both locations for the current electrode at depth, both zone H-1 and zone H-2 are probably part of a single mineralization that has its most shallow position beneath the center of the surface potential pattern.

#### 4-4. Resistivity Methods

*a. Introduction.* Surface electrical resistivity surveying is based on the principle that the distribution of electrical potential in the ground around a current-carrying electrode depends on the electrical resistivities and distribution of the surrounding soils and rocks. The usual practice in the field is to apply an electrical direct current (DC) between two electrodes implanted in the ground and to measure the difference of potential between two additional electrodes that do not carry current. Usually, the potential electrodes are in line between the current electrodes, but in principle, they can be located anywhere. The current used is either direct current, commutated direct current (i.e., a square-wave alternating current), AC of low frequency (typically about 20 Hz). All analysis and interpretation are done on the basis of direct currents. The distribution of potential can be related theoretically to ground resistivities and their distribution for some simple cases; notably, the case of a horizontally stratified ground and the case of homogeneous masses separated by vertical planes (e.g., a vertical fault with a large throw or a

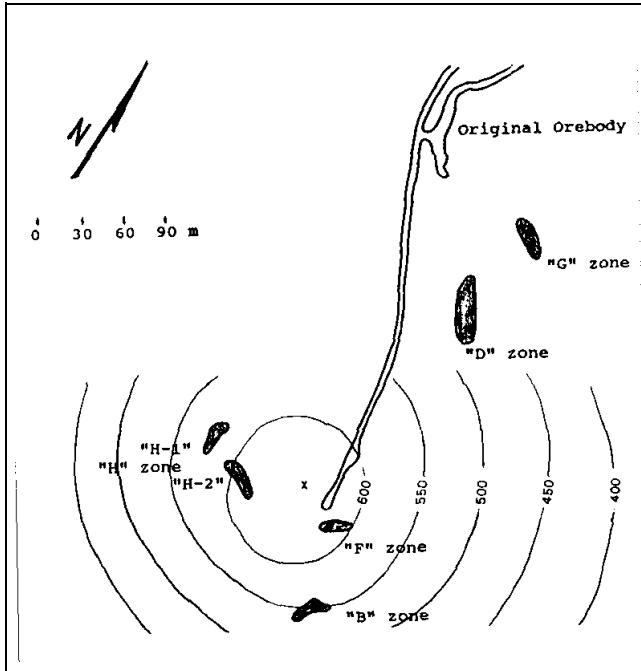

Figure 4-5. Potential pattern from current source in test position (modified from Hallof (1980))

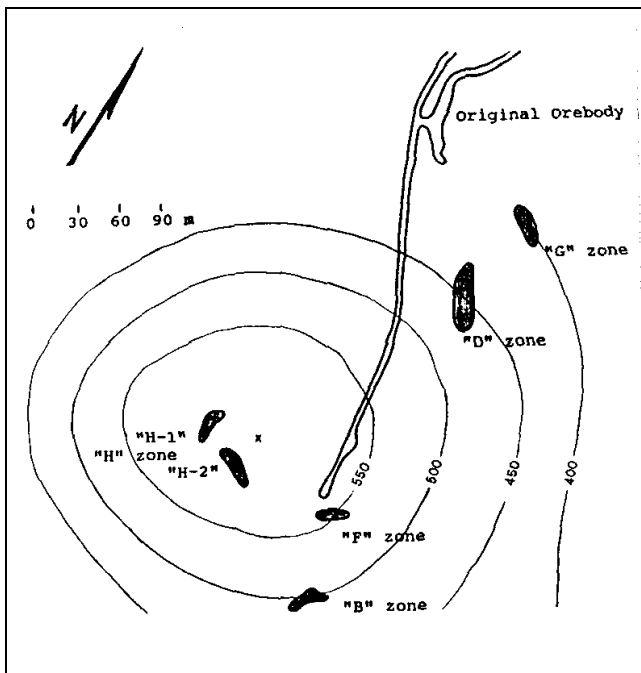

Figure 4-6. Potential pattern from current source in H-1 zone (modified from Hallof (1980))

vertical dike). For other kinds of resistivity distributions, interpretation is usually done by qualitative comparison of observed response with that of idealized hypothetical models or on the basis of empirical methods.

(1) Mineral grains composing soils and rocks are essentially nonconductive, except in some exotic materials such as metallic ores, so the resistivity of soils and rocks is governed primarily by the amount of pore water, its resistivity, and the arrangement of the pores. To the extent that differences of lithology are accompanied by differences of resistivity, resistivity surveys can be useful in detecting bodies of anomalous materials or in estimating the depths of bedrock surfaces. In coarse granular soils, the groundwater surface is generally marked by an abrupt change in water saturation and thus by a change of resistivity. In fine-grained soils, however, there may be no such resistivity change coinciding with a piezometric surface. Generally, since the resistivity of a soil or rock is controlled primarily by the pore water conditions, there are wide ranges in resistivity for any particular soil or rock type, and resistivity values cannot be directly interpreted in terms of soil type or lithology. Commonly, however, zones of distinctive resistivity can be associated with specific soil or rock units on the basis of local field or drill hole information, and resistivity surveys can be used profitably to extend field investigations into areas with very limited or nonexistent data. Also, resistivity surveys may be used as a reconnaissance method, to detect anomalies that can be further investigated by complementary geophysical methods and/or drill holes.

(2) The electrical resistivity method has some inherent limitations that affect the resolution and accuracy that may be expected from it. Like all methods using measurements of a potential field, the value of a measurement obtained at any location represents a weighted average of the effects produced over a large volume of material, with the nearby portions contributing most heavily. This tends to produce smooth curves, which do not lend themselves to high resolution for interpretations. There is another feature common to all potential field geophysical methods; a particular distribution of potential at the ground surface does not generally have a unique interpretation. While these limitations should be recognized, the non-uniqueness or ambiguity of the resistivity method is scarcely less than with the other geophysical methods. For these reasons, it is always advisable to use several complementary geophysical methods in an integrated exploration program rather than relying on a single exploration method.



b. Theory.

(1) Data from resistivity surveys are customarily presented and interpreted in the form of values of apparent resistivity  $\rho_a$ . Apparent resistivity is defined as the resistivity of an electrically homogeneous and isotropic half-space that would yield the measured relationship between the applied current and the potential difference for a particular arrangement and spacing of electrodes. An equation giving the apparent resistivity in terms of applied current, distribution of potential, and arrangement of electrodes can be arrived at through an examination of the potential distribution due to a single current electrode. The effect of an electrode pair (or any other combination) can be found by superposition. Consider a single point electrode, located on the boundary of a semi-infinite, electrically homogeneous medium, which represents a fictitious homogeneous earth. If the electrode carries a current  $I$ , measured in amperes (a), the potential at any point in the medium or on the boundary is given by

$$U = \rho \frac{I}{2\pi r} \quad (4-5)$$

where

$U$  = potential, in V

$\rho$  = resistivity of the medium

$r$  = distance from the electrode

The mathematical demonstration for the derivation of the equation may be found in textbooks on geophysics, such as Keller and Frischknecht (1966).

(a) For an electrode pair with current  $I$  at electrode A, and  $-I$  at electrode B (Figure 4-7), the potential at a point is given by the algebraic sum of the individual contributions:

$$U = \frac{\rho I}{2\pi r_A} - \frac{\rho I}{2\pi r_B} = \frac{\rho I}{2\pi} \left[ \frac{1}{r_A} - \frac{1}{r_B} \right] \quad (4-6)$$

where

$r_A$  and  $r_B$  = distances from the point to electrodes A and B

Figure 4-7 illustrates the electric field around the two electrodes in terms of equipotentials and current lines.

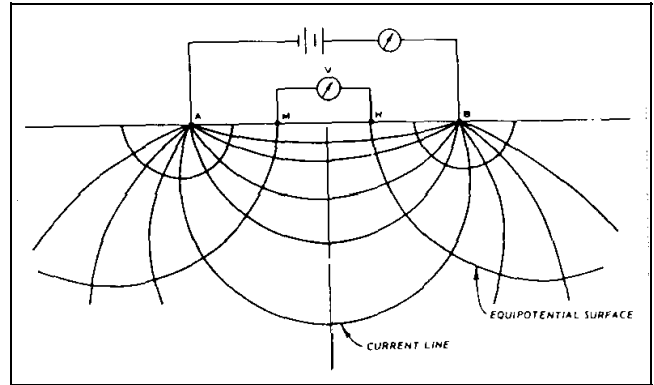

Figure 4-7. Equipotentials and current lines for a pair of current electrodes A and B on a homogeneous half-space

The equipotentials represent imagery shells, or bowls, surrounding the current electrodes, and on any one of which the electrical potential is everywhere equal. The current lines represent a sampling of the infinitely many paths followed by the current, paths that are defined by the condition that they must be everywhere normal to the equipotential surfaces.

(b) In addition to current electrodes A and B, Figure 4-7 shows a pair of electrodes M and N, which carry no current, but between which the potential difference  $V$  may be measured. Following the previous equation, the potential difference  $V$  may be written

$$V = U_M - U_N = \frac{\rho I}{2\pi} \left[ \frac{1}{AM} - \frac{1}{BM} + \frac{1}{BN} - \frac{1}{AN} \right] \quad (4-7)$$

where

$U_M$  and  $U_N$  = potentials at M and N

$AM$  = distance between electrodes A and M,  
etc.

These distances are always the actual distances between the respective electrodes, whether or not they lie on a line. The quantity inside the brackets is a function only of the various electrode spacings. The quantity is denoted  $1/K$ , which allows rewriting the equation as

$$V = \frac{\rho I}{2\pi} \frac{1}{K} \quad (4-8)$$

where

$K$  = array geometric factor

Equation 4-8 can be solved for  $\rho$  to obtain

$$\rho = 2\pi K \frac{V}{I} \quad (4-9)$$

The resistivity of the medium can be found from measured values of  $V$ ,  $I$ , and  $K$ , the geometric factor.  $K$  is a function only of the geometry of the electrode arrangement.

(2) Apparent resistivity.

(a) Wherever these measurements are made over a real heterogeneous earth, as distinguished from the fictitious homogeneous half-space, the symbol  $\rho$  is replaced by  $\rho_a$  for apparent resistivity. The resistivity surveying problem is, reduced to its essence, the use of apparent resistivity values from field observations at various locations and with various electrode configurations to estimate the true resistivities of the several earth materials present at a site and to locate their boundaries spatially below the surface of the site.

(b) An electrode array with constant spacing is used to investigate lateral changes in apparent resistivity reflecting lateral geologic variability or localized anomalous features. To investigate changes in resistivity with depth, the size of the electrode array is varied. The apparent resistivity is affected by material at increasingly greater depths (hence larger volume) as the electrode spacing is increased. Because of this effect, a plot of apparent resistivity against electrode spacing can be used to indicate vertical variations in resistivity.

(3) The types of electrode arrays that are most commonly used (Schlumberger, Wenner, and dipole-dipole) are illustrated in Figure 4-8. There are other electrode configurations which are used experimentally or for non-geotechnical problems or are not in wide popularity today. Some of these include the Lee, half-Schlumberger, polar dipole, bipole dipole, and gradient arrays. In any case, the geometric factor for any four-electrode system can be found from Equation 4-7 and can be developed for more

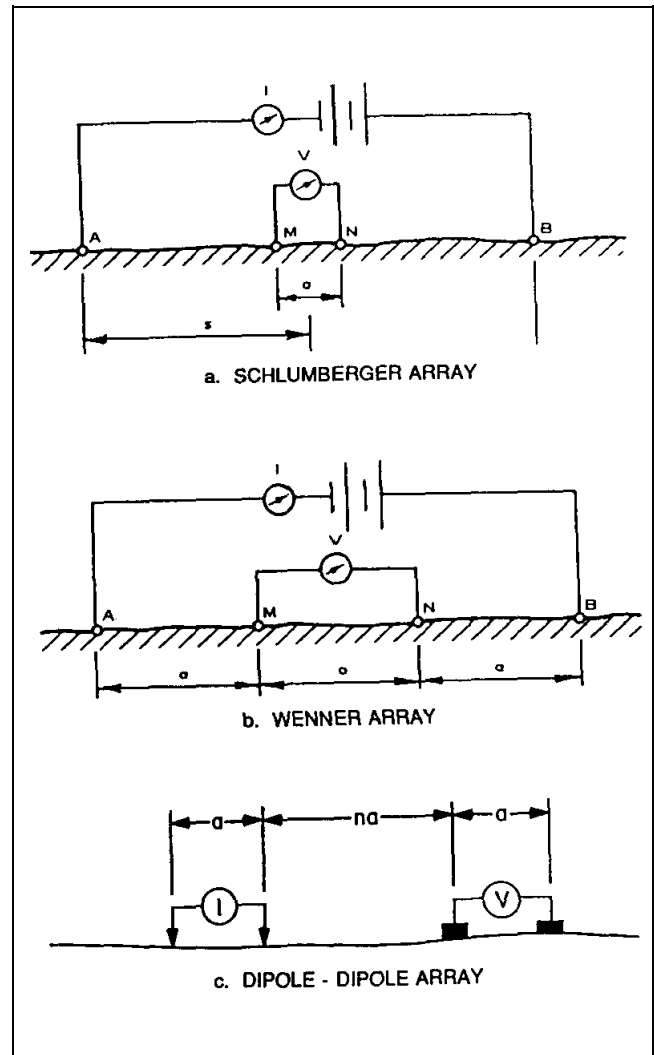

**Figure 4-8. Electrode (array) configurations for resistivity measurements**

complicated systems by using the rule illustrated by Equation 4-6. It can also be seen from Equation 4-7 that the current and potential electrodes can be interchanged without affecting the results; this property is called reciprocity.

(a) Schlumberger array (Figure 4-8a). For this array, in the limit as  $a$  approaches zero, the quantity  $V/a$  approaches the value of the potential gradient at the midpoint of the array. In practice, the sensitivity of the instruments limits the ratio of  $s$  to  $a$  and usually keeps it within the limits of about 3 to 30. Therefore, it is typical practice to use a finite electrode spacing and Equation 4-7 to compute the geometric factor (Keller and Frischknecht 1966). The apparent resistivity is:

$$\rho_a = \pi \left[ \frac{s^2}{a} - \frac{a}{4} \right] \frac{V}{I} = \pi a \left[ \left( \frac{s}{a} \right)^2 - \frac{1}{4} \right] \frac{V}{I} \quad (4-10)$$

In usual field operations, the inner (potential) electrodes remain fixed, while the outer (current) electrodes are adjusted to vary the distance  $s$ . The spacing  $a$  is adjusted when it is needed because of decreasing sensitivity of measurement. The spacing  $a$  must never be larger than  $0.4s$  or the potential gradient assumption is no longer valid. Also, the  $a$  spacing may sometimes be adjusted with  $s$  held constant in order to detect the presence of local inhomogeneities or lateral changes in the neighborhood of the potential electrodes.

(b) Wenner array. This array (Figure 4-8b) consists of four electrodes in line, separated by equal intervals, denoted  $a$ . Applying Equation 4-7, the user will find that the geometric factor  $K$  is equal to  $a$ , so the apparent resistivity is given by

$$\rho_a = 2\pi a \frac{V}{I} \quad (4-11)$$

While the Schlumberger array has always been the favored array in Europe, until recently, the Wenner array was used more extensively than the Schlumberger array in the United States. In a survey with varying electrode spacing, field operations with the Schlumberger array are faster, because all four electrodes of the Wenner array are moved between successive observations, but with the Schlumberger array, only the outer ones need to be moved. The Schlumberger array also is said to be superior in distinguishing lateral from vertical variations in resistivity. On the other hand, the Wenner array demands less instrument sensitivity, and reduction of data is marginally easier.

(4) Dipole-dipole array. The dipole-dipole array (Figure 4-8c) is one member of a family of arrays using dipoles (closely spaced electrode pairs) to measure the curvature of the potential field. If the separation between both pairs of electrodes is the same  $a$  and the separation between the centers of the dipoles is restricted to  $a(n+1)$ , the apparent resistivity is given by

$$\rho_a = \pi a n(n+1)(n+2) \frac{V}{I} \quad (4-12)$$

This array is especially useful for measuring lateral resistivity changes and has been increasingly used in geotechnical applications.

*c. Depth of investigation.* To illustrate the major features of the relationship between apparent resistivity and electrode spacing, Figure 4-9 shows a hypothetical earth model and some hypothetical apparent resistivity curves. The earth model has a surface layer of resistivity  $\rho_1$  and a "basement" layer of resistivity  $\rho_n$  that extends downward to infinity. There may be intermediate layers of arbitrary thicknesses and resistivities. The electrode spacing may be either the Wenner spacing  $a$  or the Schlumberger spacing  $a$ ; curves of apparent resistivity versus spacing will have the same general shape for both arrays, although they will not generally coincide.

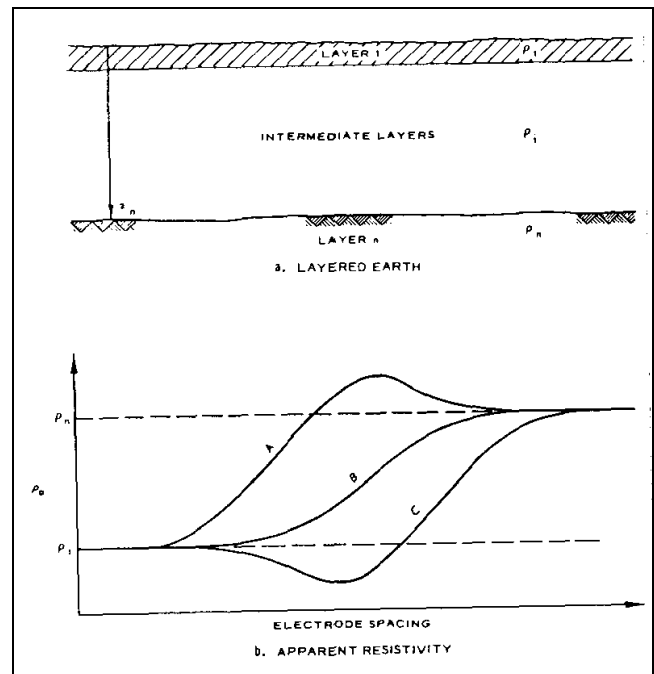

**Figure 4-9. Asymptotic behavior of the apparent resistivity curves at very small and very large electrode spacings**

(1) For small electrode spacings, the apparent resistivity is close to the surface layer resistivity, while at large electrode spacings, it approaches the resistivity of the basement layer. Every apparent resistivity curve thus has two asymptotes, the horizontal lines  $\rho_a = \rho_1$  and  $\rho_a = \rho_n$ , that it approaches at extreme values of electrode

spacing. This is true whether  $\rho_n$  is greater than  $\rho_1$ , as shown in Figure 4-9b, or the reverse. The behavior of the curve between the regions where it approaches the asymptotes depends on the distribution of resistivities in the intermediate layers. Curve A represents a case in which there is an intermediate layer with a resistivity greater than  $\rho_n$ . The behavior of curve B resembles that for the two-layer case or a case where resistivities increase from the surface down to the basement. The curve might look like curve C if there were an intermediate layer with resistivity lower than  $\rho_1$ . Unfortunately for the interpreter, neither the maximum of curve A nor the minimum of curve C reach the true resistivity values for the intermediate layers, though they may be close if the layers are very thick.

(2) There is no simple relationship between the electrode spacing at which features of the apparent resistivity curve are located and the depths to the interfaces between layers. The depth of investigation will ALWAYS be less than the electrode spacing. Typically, a maximum electrode spacing of three or more times the depth of interest is necessary to assure that sufficient data have been obtained. The best general guide to use in the field is to plot the apparent resistivity curve (Figure 4-9b) as the survey progresses, so that it can be judged whether the asymptotic phase of the curve has been reached.

*d. Instruments and measurements.* The theory and field methods used for resistivity surveys are based on the use of direct current, because it allows greater depth of investigation than alternating current and because it avoids the complexities caused by effects of ground inductance and capacitance and resulting frequency dependence of resistivity. However, in practice, actual direct current is infrequently used for two reasons: (1) direct current electrodes produce polarized ionization fields in the electrolytes around them, and these fields produce additional electromotive forces that cause the current and potentials in the ground to be different from those in the electrodes; and (2) natural earth currents (telluric currents) and spontaneous potentials, which are essentially unidirectional or slowly time-varying, induce potentials in addition to those caused by the applied current. The effects of these phenomena, as well as any others that produce unidirectional components of current or potential gradients, are reduced by the use of alternating current, because the polarized ionization fields do not have sufficient time to develop in a half-cycle, and the alternating component of the response can be measured independently of any superimposed direct currents. The frequencies used are very low, typically below 20 Hz, so that the measured

resistivity is essentially the same as the direct current resistivity.

(1) In concept, a direct current (I), or an alternating current of low frequency, is applied to the current electrodes, and the current is measured with an ammeter. Independently, a potential difference  $V$  is measured across the potential electrodes, and ideally there should be no current flowing between the potential electrodes. This is accomplished either with a null-balancing galvanometer (old technology) or very high input impedance operational amplifiers. A few resistivity instruments have separate "sending" and "receiving" units for current and potential; but in usual practice, the potential measuring circuit is derived from the same source as the potential across the current electrodes, so that variations in the supply voltage affect both equally and do not affect the balance point.

(2) Power is usually supplied by dry cell batteries in the smaller instruments and motor generators in the larger instruments. From 90 V up to several hundred volts may be used across the current electrodes in surveys for engineering purposes. In the battery-powered units, the current usually is small and is applied only for very short times while the potential is being measured, so battery consumption is low. Care should be taken to NEVER energize the electrodes while they are being handled, because with applied potentials of hundreds of volts, DANGEROUS AND POTENTIALLY LETHAL shocks could be caused.

(3) Current electrodes used with alternating current (or commutated direct current) instruments commonly are stakes of bronze, copper, steel with bronze jackets, or, less desirably, steel, about 50 cm in length. They must be driven into the ground far enough to make good electrical contact. If there is difficulty because of high contact resistance between electrodes and soil, it can sometimes be alleviated by pouring salt water around the electrodes. Many resistivity instruments include an ammeter to verify that the current between the current electrodes is at an acceptable level, a desirable feature. Other instruments simply output the required potential difference to drive a selected current into the current electrodes. Typical currents in instruments used for engineering applications range from 2 mA to 500 mA. If the current is too small, the sensitivity of measurement is degraded. The problem may be corrected by improving the electrical contacts at the electrodes. However, if the problem is due to a combination of high earth resistivity and large electrode spacing, the remedy is to increase the voltage across the current electrodes. Where the ground is too hard or rocky

to drive stakes, a common alternative is sheets of aluminum foil buried in shallow depressions or within small mounds of earth and wetted.

(4) One advantage of the four-electrode method is that measurements are not sensitive to contact resistance at the potential electrodes so long as it is low enough that a measurement can be made, because observations are made with the system adjusted so that there is no current in the potential electrodes. With zero current, the actual value of contact resistance is immaterial, since it does not affect the potential. On the current electrodes, also, the actual value of contact resistance does not affect the measurement, so long as it is small enough that a satisfactory current is obtained, and so long as there is no gross difference between the two electrodes. Contact resistance affects the relationship between the current and the potentials on the electrodes, but because only the measured value of current is used, the potentials on these electrodes do not figure in the theory or interpretation.

(5) When direct current is used, special provisions must be made to eliminate the effects of electrode polarization and telluric currents. A nonpolarizing electrode is available in the form of a porous, unglazed ceramic pot, which contains a central metallic electrode, usually copper, and is filled with a liquid electrolyte that is a saturated solution of a salt of the same metal (copper sulphate is used with copper). The central electrode is connected to the instrument, and electrical contact with the ground is made through the electrolyte in the pores of the ceramic pot. This type of electrode may be advantageous for use on rock surfaces where driving rod-type electrodes is difficult. Good contact of the pot with the ground can be aided by clearing away grass and leaves beneath it, embedding it slightly in the soil, and if the ground is dry, pouring a small amount of water on the surface before placing the pot. The pots must be filled with electrolyte several hours before they are used to allow the electrolyte to penetrate the fine pores of the ceramic. The porous pot electrodes should be checked every several hours during the field day to verify the electrolyte level and the presence of the solid salt to maintain the saturated solution.

(6) Telluric currents are naturally occurring electric fields that are widespread, some being of global scale. They are usually of small magnitude, but may be very large during solar flares or if supplemented by currents of artificial origin. Spontaneous potentials in the earth may be generated by galvanic phenomena around electrochemically active materials, such as pipes, conduits, buried scrap materials, cinders, and ore deposits. They may also

occur as streaming potentials generated by groundwater movement. (Electric fields associated with groundwater movement will have the greatest amplitude where groundwater flow rates are high, such as through subsurface open-channel flow. Groundwater movement in karst areas can exhibit rapid flow through dissolved channels within the rock. Springs and subsurface flow may be the cause of telluric sources, which may obscure resistivity measurements.) Telluric currents and spontaneous potential effects can be compensated by applying a bias potential to balance the potential electrodes before energizing the current electrodes. Because telluric currents generally vary with time, frequent adjustments to the bias potential may be necessary in the course of making an observation. If the instrument lacks a provision for applying a bias potential, a less satisfactory alternative is to use a polarity reversing switch to make readings with alternately reversed current directions in the current electrodes. The average values of  $V$  and  $I$  for the forward and reverse current directions are then used to compute the apparent resistivity.

(7) Layout of electrodes should be done with non-conducting measuring tapes, since tapes of conducting materials, if left on the ground during measurement, can influence apparent resistivity values. Resistivity measurements can also be affected by metallic fences, rails, pipes, or other conductors, which may induce spontaneous potentials and in addition provide short-circuit paths for the current. The effects of such linear conductors as these can be minimized, but not eliminated, by laying out the electrode array on a line perpendicular to the conductor; but in some locations, such as some urban areas, there may be so many conductive bodies in the vicinity that this cannot be done. Also, electrical noise from power lines, cables, or other sources may interfere with measurements. Because of the nearly ubiquitous noise from 60-Hz power sources in the United States, the use of 60 Hz or its harmonics in resistivity instruments is not advisable. In some cases, the quality of data affected by electrical noise can be improved by averaging values obtained from a number of observations; sometimes electrical noise comes from temporary sources, so better measurements can be obtained by waiting until conditions improve. Occasionally, ambient electrical noise and other disturbing factors at a site may make resistivity surveying infeasible. Modern resistivity instruments have capability for data averaging or stacking; this allows resistivity surveys to proceed in spite of most noisy site conditions and to improve signal-to-noise ratio for weak signals.

*e. Field procedures.* Resistivity surveys are made to satisfy the needs of two distinctly different kinds of

interpretation problems: (1) the variation of resistivity with depth, reflecting more or less horizontal stratification of earth materials; and (2) lateral variations in resistivity that may indicate soil lenses, isolated ore bodies, faults, or cavities. For the first kind of problem, measurements of apparent resistivity are made at a single location (or around a single center point) with systematically varying electrode spacings. This procedure is sometimes called vertical electrical sounding (VES), or vertical profiling. Surveys of lateral variations may be made at spot or grid locations or along definite lines of traverse, a procedure sometimes called horizontal profiling.

(1) Vertical electrical sounding (VES). Either the Schlumberger or, less effectively, the Wenner array is used for sounding, since all commonly available interpretation methods and interpretation aids for sounding are based on these two arrays. In the use of either method, the center point of the array is kept at a fixed location, while the electrode locations are varied around it. The apparent resistivity values, and layer depths interpreted from them, are referred to the center point.

(a) In the Wenner array, the electrodes are located at distances of  $a/2$  and  $3a/2$  from the center point. The most convenient way to locate the electrode stations is to use two measuring tapes, pinned with their zero ends at the center point and extending away from the center in opposite directions. After each reading, each potential electrode is moved out by half the increment in electrode spacing, and each current electrode is moved out by 1.5 times the increment. The increment to be used depends on the interpretation methods that will be applied. In most interpretation methods, the curves are sampled at logarithmically spaced points. The ratio between successive spacings can be obtained from the relation

$$\frac{a_i}{a_{i-1}} = 10^{\frac{1}{n}} \quad (4-13)$$

where

$n$  = number of points to be plotted in each logarithmic cycle

For example, if six points are wanted for each cycle of the logarithmic plot, then each spacing  $a$  will be equal to 1.47 times the previous spacing. The sequence starting at 10 m would then be 10, 14.7, 21.5, 31.6, 46.4, 68.2, which for convenience in layout and plotting could be rounded to 10, 15, 20, 30, 45, 70. In the next cycle, the

spacings would be 100, 150, 200, and so on. Six points per cycle is the minimum recommended; 10, 12, or even more per cycle may be necessary in noisy areas.

(b) VES surveys with the Schlumberger array are also made with a fixed center point. An initial spacing  $s$  (the distance from the center of the array to either of the current electrodes) is chosen, and the current electrodes are moved outward with the potential electrodes fixed. According to Van Nostrand and Cook (1966) errors in apparent resistivity are within 2 to 3 percent if the distance between the potential electrodes does not exceed  $2s/5$ . Potential electrode spacing is therefore determined by the minimum value of  $s$ . As  $s$  is increased, the sensitivity of the potential measurement decreases; therefore, at some point, if  $s$  becomes large enough, it will be necessary to increase the potential electrode spacing. The increments in  $s$  should normally be logarithmic and can be chosen in the same way as described for the Wenner array.

(c) For either type of electrode array, minimum and maximum spacings are governed by the need to define the asymptotic phases of the apparent resistivity curve and the needed depth of investigation. Frequently, the maximum useful electrode spacing is limited by available time, site topography, or lateral variations in resistivity. For the purpose of planning the survey, a maximum electrode spacing of a least three times the depth of interest may be used, but the apparent resistivity curve should be plotted as the survey progresses in order to judge whether sufficient data have been obtained. Also, the progressive plot can be used to detect errors in readings or spurious resistivity values due to local effects. Sample field data sheets are shown in Figures 4-10 through 4-12.

(2) In a normal series of observations, the total resistance,  $R = V/I$ , decreases with increasing electrode spacing. Occasionally, the normal relationship may be reversed for one or a few readings. If these reversals are not a result of errors in reading, they are caused by some type of lateral or local changes in resistivity of the soil or rock. Such an effect can be caused by one current electrode being placed in a material of much higher resistivity than that around the other; for instance, in a pocket of dry gravel, in contact with a boulder of highly resistive rock, or close to an empty cavity. Systematic reversals might be caused by thinning of a surface conductive stratum where an underlying resistant stratum approaches the surface because it dips steeply or because of surface topography. In hilly terrains, the line of electrodes should be laid out along a contour if possible. Where beds are known to dip steeply (more than about 10 deg), the line

**SCHLUMBERGER ELECTRICAL RESISTIVITY DATA SHEET**

STATION NO. \_\_\_\_\_ DIRECTION \_\_\_\_\_ DATE \_\_\_\_\_  
 PROJECT \_\_\_\_\_ LOCATION \_\_\_\_\_  
 OPERATOR \_\_\_\_\_ EQUIP \_\_\_\_\_  
 REMARKS \_\_\_\_\_

$$\rho_a = \pi b \left[ \left( \frac{a}{b} \right) - \frac{1}{4} \right] \frac{V}{I}$$

a (AB)/2 (m)	b MN (m)	V (mv)	I (ma)	R=V/I (ohms)	$\rho_a$ (ohm-m)	remarks

Figure 4-10. Data sheet for Schlumberger vertical sounding

**WENNER ELECTRICAL RESISTIVITY DATA SHEET**

STATION NO. \_\_\_\_\_ DIRECTION \_\_\_\_\_ DATE \_\_\_\_\_

PROJECT \_\_\_\_\_ LOCATION \_\_\_\_\_

OPERATOR \_\_\_\_\_ EQUIP \_\_\_\_\_

REMARKS \_\_\_\_\_

$$\rho_a = 2 \pi a \frac{V}{I}$$

a	V	I	R=V/I	$\rho_a$	remarks
(m)	(mv)	(ma)	(ohms)	(ohm-m)	

Figure 4-11. Data sheet for Wenner array



**DIPOLE-DIPOLE ELECTRICAL RESISTIVITY DATA SHEET**

STATION NO. \_\_\_\_\_ DIRECTION \_\_\_\_\_ DATE \_\_\_\_\_

PROJECT \_\_\_\_\_ LOCATION \_\_\_\_\_

OPERATOR \_\_\_\_\_ EQUIP \_\_\_\_\_

REMARKS \_\_\_\_\_ DIPOLE LENGTH \_\_\_\_\_ m

$$\rho_a = \pi a n(n+1)(n+2) \frac{V}{I}$$

TX	RX	n	V (mv)	I (ma)	R=V/I (ohms)	ρ <sub>a</sub> (ohm-m)	remarks

Figure 4-12. Data sheet for dipole-dipole array

should be laid out along the strike. Electrodes should not be placed in close proximity to boulders, so it may sometimes be necessary to displace individual electrodes away from the line. The theoretically correct method of displacing one electrode, e.g., the current electrode A, would be to place it at a new position A' such that the geometric factor  $K$  is unchanged. This condition would be satisfied (see Equation 4-7) if

$$\frac{1}{AM} - \frac{1}{AN} = \frac{1}{A'M} - \frac{1}{A'N} \quad (4-14)$$

If the electrode spacing is large as compared with the amount of shift, it is satisfactory to shift the electrode on a line perpendicular to the array. For large shifts, a reasonable approximation is to move the electrode along an arc centered on the nearest potential electrode, so long as it is not moved more than about 45 deg off the line.

(3) The plot of apparent resistivity versus spacing is always a smooth curve where it is governed only by vertical variation in resistivity. Reversals in resistance and irregularities in the apparent resistivity curve, if not due to errors, both indicate lateral changes and should be further investigated. With the Wenner array, the Lee modification may be used to detect differences from one side of the array to the other, and a further check can be made by taking a second set of readings at the same location but on a perpendicular line. Where the Schlumberger array is used, changing the spacing of the potential electrodes may produce an offset in the apparent resistivity curve as a result of lateral inhomogeneity. Such an offset may occur as an overall shift of the curve without much change in its shape (Zohdy 1968). Under such conditions, the cause of the offset can often be determined by repeating portions of the sounding with different potential electrode spacing.

(4) Horizontal profiling. Surveys of lateral variations in resistivity can be useful for the investigation of any geological features that can be expected to offer resistivity contrasts with their surroundings. Deposits of gravel, particularly if unsaturated, have high resistivity and have been successfully prospected for by resistivity methods. Steeply dipping faults may be located by resistivity traverses crossing the suspected fault line, if there is sufficient resistivity contrast between the rocks on the two sides of the fault. Solution cavities or joint openings may be detected as a high resistivity anomaly, if they are open, or low resistivity anomaly if they are filled with soil or water.

(a) Resistivity surveys for the investigation of areal geology are made with a fixed electrode spacing, by moving the array between successive measurements. Horizontal profiling, per se, means moving the array along a line of traverse, although horizontal variations may also be investigated by individual measurements made at the points of a grid. If a symmetrical array, such as the Schlumberger or Wenner array, is used, the resistivity value obtained is associated with the location of the center of the array. Normally, a vertical survey would be made first to determine the best electrode spacing. Any available geological information, such as the depth of the features of interest, should also be considered in making this decision, which governs the effective depth of investigation. The spacing of adjacent resistivity stations, or the fineness of the grid, governs the resolution of detail that may be obtained. This is very much influenced by the depths of the features, and the achievable resolution diminishes with depth. As a general rule, the spacing between resistivity stations should be smaller than the width of the smallest feature to be detected, or smaller than the required resolution in the location of lateral boundaries.

(b) Field data may be plotted in the form of profiles or as contours on a map of the surveyed area. For a contour map, resistivity data obtained at grid points are preferable to those obtained from profile lines, unless the lines are closely spaced, because the alignment of data along profiles tends to distort the contour map and gives it an artificial "grain" that is distracting and interferes with interpretation of the map. The best method of data collection for a contour map is to use a square grid, or at least a set of stations with uniform coverage of the area, and without directional bias.

(c) Occasionally, a combination of vertical and horizontal methods may be used. Where mapping of the depth to bedrock is desired, a vertical sounding may be done at each of a set of grid points. However, before a commitment is made to a comprehensive survey of this type, the results of resistivity surveys at a few stations should be compared with the drill hole logs. If the comparison indicates that reliable quantitative interpretation of the resistivity can be made, the survey can be extended over the area of interest.

(d) When profiling is done with the Wenner array, it is convenient to use a spacing between stations equal to the electrode spacing, if this is compatible with the spacing requirements of the problem and the site conditions.

In moving the array, the rearmost electrode need only be moved a step ahead of the forward electrode, by a distance equal to the electrode spacing. The cables are then reconnected to the proper electrodes and the next reading is made. With the Schlumberger array, however, the whole set of electrodes must be moved between stations.

(5) Detection of cavities. Subsurface cavities most commonly occur as solution cavities in carbonate rocks. They may be empty or filled with soil or water. In favorable circumstances, either type may offer a good resistivity contrast with the surrounding rock since carbonate rocks, unless porous and saturated, usually have high resistivities, while soil or water fillings are usually conductive, and the air in an empty cavity is essentially non-conductive. Wenner or Schlumberger arrays may be used with horizontal profiling to detect the resistivity anomalies produced by cavities, although reports in the literature indicate mixed success. The probability of success by this method depends on the site conditions and on the use of the optimum combination of electrode spacing and interval between successive stations. Many of the unsuccessful surveys are done with an interval too large to resolve the anomalies sought.

*f. Interpretation of vertical electrical sounding data.* The interpretation problem for VES data is to use the curve of apparent resistivity versus electrode spacing, plotted from field measurements, to obtain the parameters of the geoelectrical section: the layer resistivities and thicknesses. From a given set of layer parameters, it is always possible to compute the apparent resistivity as a function of electrode spacing (the VES curve); but unfortunately, for the converse of that problem, it is not generally possible to obtain a unique solution. There is an interplay between thickness and resistivity; there may be anisotropy of resistivity in some strata; large differences in geoelectrical section, particularly at depth, produce small differences in apparent resistivity; and accuracy of field measurements is limited by the natural variability of surface soil and rock and by instrument capabilities. As a result, different sections may be electrically equivalent within the practical accuracy limits of the field measurements.

(1) To deal with the problem of ambiguity, the interpreter should check all interpretations by computing the theoretical VES curve for the interpreted section and comparing it with the field curve. The test of geological reasonableness should be applied. In particular, interpreted thin beds with unreasonably high resistivity contrasts are likely to be artifacts of interpretation rather than

real features. Adjustments to the interpreted values may be made on the basis of the computed VES curves and checked by computing the new curves. Because of the accuracy limitations caused by instrumental and geological factors, effort should not be wasted on excessive refinement of the interpretation. As an example, suppose a set of field data and a three-layer theoretical curve agree within 10 percent. Adding several thin layers to achieve a fit of 2 percent is rarely a "better" geologic fit.

(2) All of the direct interpretation methods, except some empirical and semi-empirical methods such as the Moore cumulative method and the Barnes layer method which should be avoided, rely on curve-matching, in some form, to obtain the layer parameters. Because the theoretical curves are always smooth, the field curves should be smoothed before their interpretation is begun, to remove obvious observational errors and effects of lateral variability. Isolated one-point "spikes" in resistivity are removed rather than interpolated. The curves should be inspected for apparent distortion due to effects of lateral variations. Comparison with theoretical multilayer curves is helpful in detecting such distortion. The site conditions should be considered; excessive dip of subsurface strata along the survey line (more than about 10 percent), unfavorable topography, or known high lateral variability in soil or rock properties may be reasons to reject field data as unsuitable for interpretation in terms of simple vertical variation of resistivity.

(a) The simplest multilayer case is that of a single layer of finite thickness overlying a homogeneous half-space of different resistivity. The VES curves for this case vary in a relatively simple way, and a complete set of reference curves can be plotted on a single sheet of paper. Standard two-layer curves for the Schlumberger array are included in Figure 4-13. The curves are plotted on a logarithmic scale, both horizontally and vertically, and are normalized by plotting the ratio of apparent resistivity to the first layer resistivity ( $\rho_a/\rho_1$ ) against the ratio of electrode spacing to the first layer thickness ( $a/d_1$ ). Each curve of the family represents one value of the parameter  $k$ , which is defined by

$$k = \frac{\rho_2 - \rho_1}{\rho_2 + \rho_1} \quad (4-15)$$

Because the apparent resistivity for small electrode spacings approaches  $\rho_1$  and for large spacings approaches  $\rho_2$ , these curves begin at  $\rho_a/\rho_1 = 1$ , and asymptotically approach  $\rho_a/\rho_1 = \rho_2/\rho_1$ .

(b) Any two-layer curve for a particular value of  $k$ , or for a particular ratio of layer resistivities, must have the same shape on the logarithmic plot as the corresponding standard curve. It differs only by horizontal and vertical shifts, which are equal to the logarithms of the thickness and resistivity of the first layer. The early (i.e., corresponding to the smaller electrode spacings) portion of more complex multiple-layer curves can also be fitted to two-layer curves to obtain the first layer parameters  $\rho_1$  and  $d_1$  and the resistivity  $\rho_2$  of layer 2. The extreme curves in Figure 4-13 correspond to values of  $k$  equal to 1.0 and -1.0; these values represent infinitely great resistivity contrasts between the upper and lower layers. The first case represents a layer 2 that is a perfect insulator; the second, a layer 2 that is a perfect conductor. The next nearest curves in both cases represent a ratio of 19 in the layer resistivities. Evidently, where the resistivity contrast is more than about 20 to 1, fine resolution of the layer 2 resistivity cannot be expected. Loss of resolution is not merely an effect of the way the curves are plotted, but is representative of the basic physics of the problem and leads to ambiguity in the interpretation of VES curves.

(c) Where three or more strata of contrasting resistivity are present, the VES curves are more complex than the two-layer curves. For three layers, there are four possible types of VES curves, as shown in Figure 4-14, depending on the nature of the successive resistivity contrasts. The classification of these curves is found in the literature with the notations H, K, A, and Q. These symbols correspond respectively to bowl-type curves, which occur with an intermediate layer of lower resistivity than layers 1 or 3; bell-type curves, where the intermediate layer is of higher resistivity; ascending curves, where resistivities successively increase; and descending curves, where resistivities successively decrease. With four layers, another curve segment is present, so that 16 curve types can be identified: HK for a bowl-bell curve, AA for a monotonically ascending curve, and so on.

(d) Before the availability of personal computers, the curve matching process was done graphically by plotting the field data plotted on transparent log-log graph paper at the same scale of catalogs of two- and three-layer standard curves. The use of standard curves requires an identification of the curve type followed by a comparison with standard curves of that type to obtain the best match. Two-layer and three-layer curves can be used for complete interpretation of VES curves of more layers by the Auxiliary Point Method, which requires the use of a small set of auxiliary curves and some constructions. Discussions and step-by-step examples of this method are given by Zohdy (1965), Orellana and Mooney (1966), and

Keller and Frischknecht (1966). Sets of standard curves have been developed by several workers. Orellana and Mooney (1966) published a set of 1,417 two-, three-, and four-layer Schlumberger curves, accompanied by a set of auxiliary curves, and tabulated values for both Schlumberger and Wenner curves. Apparent resistivity values for 102 three-layer Wenner curves were published by Wetzel and McMurray (1937). A collection of 2,400 two-, three-, and four-layer curves was published by Mooney and Wetzel (1956). Most, if not all, of these publications are out of print, but copies may be available in libraries.

(3) Ghosh (1971a, 1971b) and Johansen (1975) used linear filter theory to develop a fast numerical method for computing apparent resistivity values from the resistivity transforms, and vice versa. With these methods, new standard curves or trial VES curves can be computed as needed, with a digital computer or a calculator, either to match the curves or to check the validity of an interpretation of the field data. Thus, trial-and-error interpretation of VES data is feasible. Trial values of the layer parameters can be guessed, checked with a computed apparent resistivity curve, and adjusted to make the field and computed curves agree. The process will be much faster, of course, if the initial guess is guided by a semiquantitative comparison with two- and three-layer curves. Computer programs have been written by Zohdy (1973, 1974a, 1975), Zohdy and Bisdorf (1975), and several commercial software companies for the use of this method to obtain the layer parameters automatically by iteration, starting with an initial estimate obtained by an approximate method. Most computer programs require a user-supplied initial estimate (model), while some programs can optionally generate the initial mode. After a suite of sounding curves have been individually interpreted in this manner, a second pass can be made where certain layer thicknesses and/or resistivities can be fixed to give a more consistent project-wide interpretation.

*g. Interpretation of horizontal profiling data.* Data obtained from horizontal profiling, for engineering applications, are normally interpreted qualitatively. Apparent resistivity values are plotted and contoured on maps, or plotted as profiles, and areas displaying anomalously high or low values, or anomalous patterns, are identified. Interpretation of the data, as well as the planning of the survey, must be guided by the available knowledge of the local geology. The interpreter normally knows what he is looking for in terms of geological features and their expected influence on apparent resistivity, because the resistivity survey is motivated by geological evidence of a particular kind of exploration problem (e.g., karst terrain).

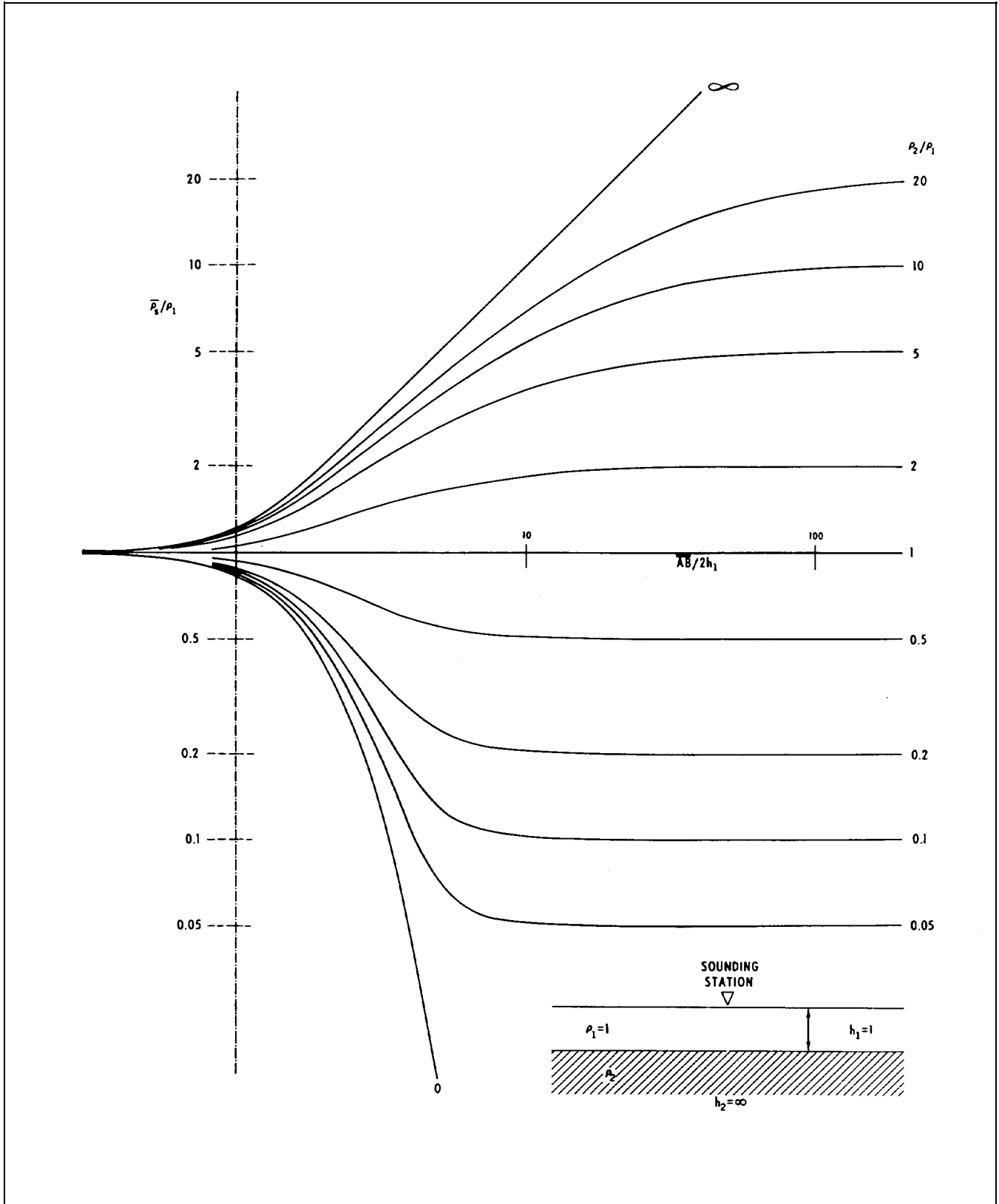

Figure 4-13. Two-layer master set of sounding curves for the Schlumberger array (Zohdy 1974a, 1974b)

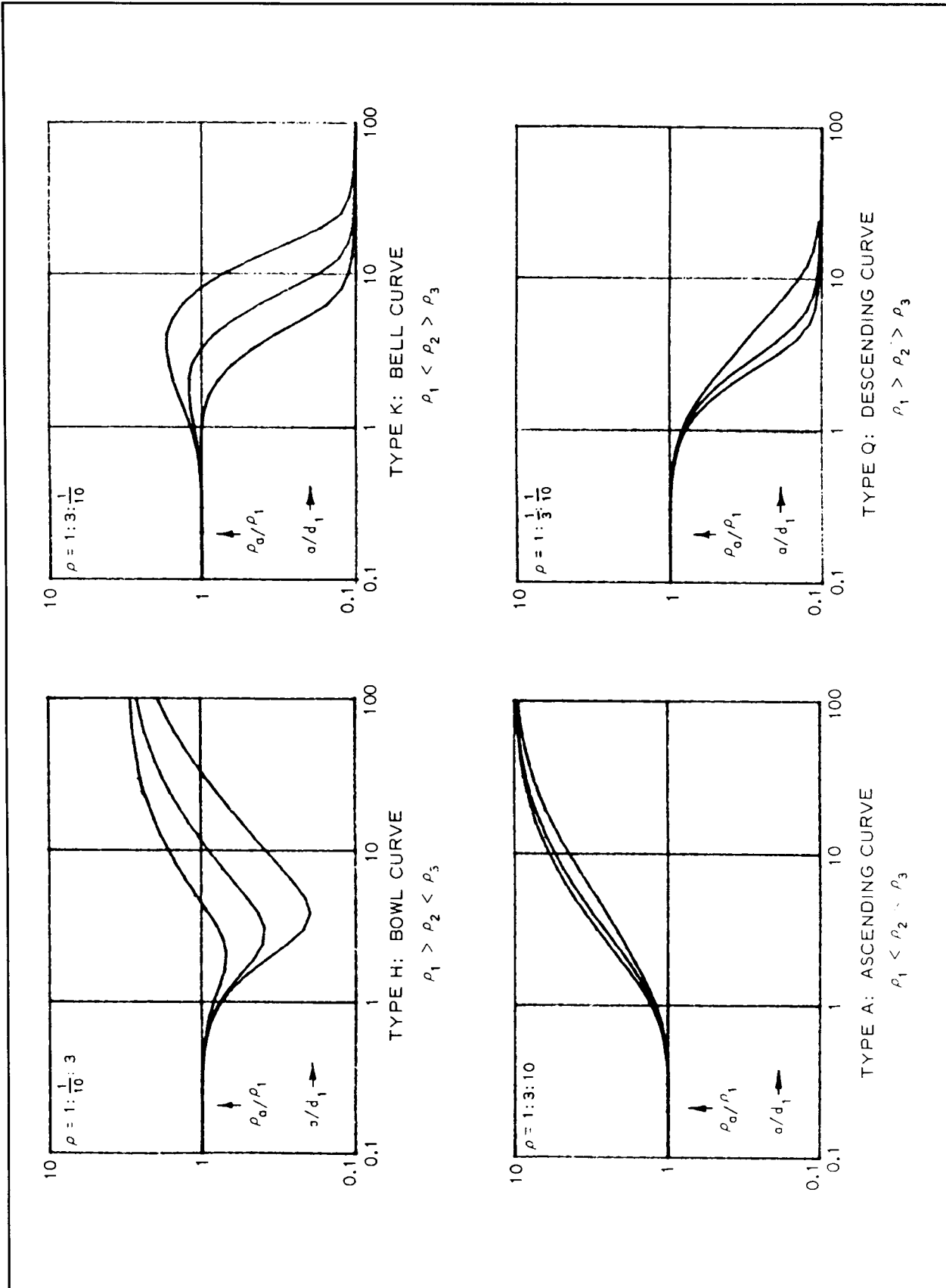

Figure 4-14. Four types of three-layer VES curves; the three sample curves for each of the four types represent values of  $d_2/d_1 = 1/3, 1,$  and  $3$

The survey is then executed in a way that is expected to be most responsive to the kinds of geological or hydrogeological features sought. A pitfall inherent in this approach is that the interpreter may be misled by his preconceptions if he is not sufficiently alert to the possibility of the unexpected occurring. Alternative interpretations should be considered, and evidence from as many independent sources as possible should be applied to the interpretation. One way to help plan the survey is to construct model VES sounding curves for the expected models, vary each model parameter separately by say 20 percent and then choose electrode separations that will best resolve the expected resistivity/depth variations. Most investigators then perform a number of VES soundings to verify and refine the model results before commencing horizontal profiling.

(1) The construction of theoretical profiles is feasible for certain kinds of idealized models, and the study of such profiles is very helpful in understanding the significance of field profiles. Van Nostrand and Cook (1966) give a comprehensive discussion of the theory of electrical resistivity interpretation and numerous examples of resistivity profiles over idealized models of faults, dikes, filled sinks, and cavities.

(2) Figure 4-15 illustrates a theoretical Wenner profile crossing a fault, a situation that can be thought of more generally as a survey line crossing any kind of abrupt transition between areas of different resistivity. The figure compares a theoretical curve, representing continuous variation of apparent resistivity with location of the center of the electrode array, and a theoretical field curve that would be obtained with an interval of  $a/2$  between stations. More commonly, an interval equal to the electrode spacing would be used; various theoretical field curves for that case can be drawn by connecting points on the continuous curve at intervals of  $a$ . These curves would fail to reveal much of the detail of the continuous curve and could look quite different from one another. Figure 4-16 illustrates a profile across a shale-filled sink (i.e., a body of relatively low resistivity) and compares it with the theoretical continuous curve and a theoretical field curve. The theoretical curves are for a conductive body exposed at the surface, while the field case has a thin cover of alluvium, but the curves are very similar. Figure 4-17a shows a number of theoretical continuous profiles across buried perfectly insulating cylinders. This model would closely approximate a sub-surface tunnel and less closely an elongated cavern. A spherical cavern would produce a similar response but with less pronounced maxima and minima. Figure 4-17b

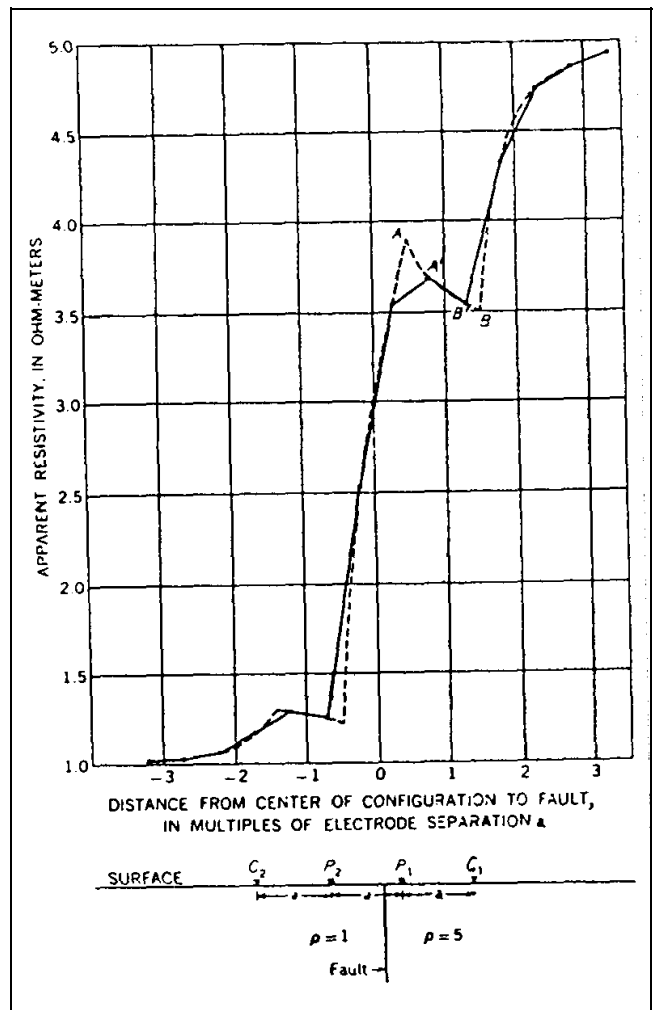

Figure 4-15. Wenner horizontal resistivity profile over a vertical fault; typical field curve (solid line), theoretical curve (dashed line) (Van Nostrand and Cook 1966)

shows a set of similar curves for cylinders of various resistivity contrasts.

**4-5. Induced Polarization**

a. *Introduction.* Conrad Schlumberger (Dobrin 1960) probably was first to report the induced polarization phenomenon, which he called “provoked polarization.” While making conventional resistivity measurements, he noted that the potential difference, measured between the potential electrodes, often did not drop instantaneously to zero when the current was turned off. Instead, the potential difference dropped sharply at first, then gradually decayed to zero after a given interval of time. Certain layers in the ground can become electrically polarized,

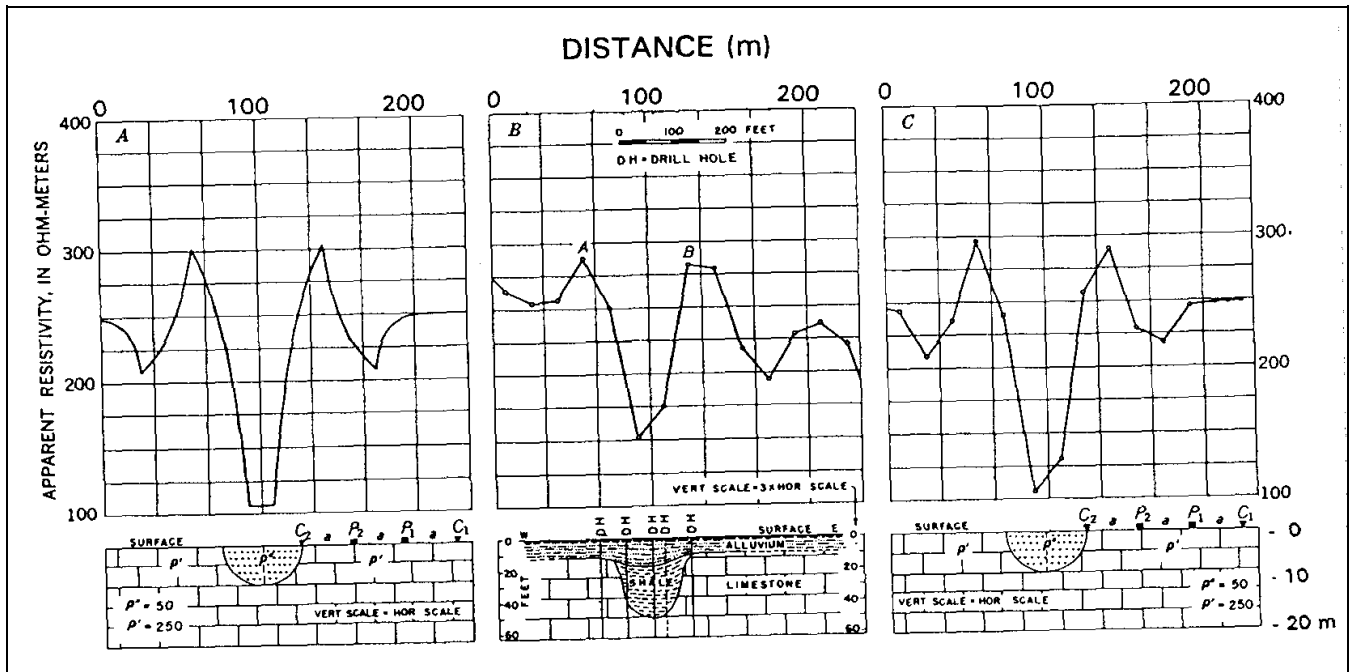

Figure 4-16. Wenner horizontal resistivity profiles over a filled sink: (a) continuous theoretical curve over hemispherical sink, (b) observed field curve with geologic cross section, (c) theoretical field plot over hemispherical sink (Van Nostrand and Cook 1966)

forming a battery when energized with an electric current. Upon turning off the polarizing current, the ground gradually discharges and returns to equilibrium.

(1) The study of the decaying potential difference as a function of time is now known as the study of induced polarization (IP) in the "time domain." In this method the geophysicist looks for portions of the earth where current flow is maintained for a short time after the applied current is terminated. Another technique is to study the effect of alternating currents on the measured value of resistivity, which is called IP in the "frequency domain." In this method the geophysicist tries to locate portions of the earth where resistivity decreases as the frequency of applied current is increased. The induced electrical polarization method is widely used in exploration for ore bodies, principally of disseminated sulfides. Use of IP in geotechnical and engineering applications has been limited, and has been mainly for groundwater exploration. Groundwater IP studies generally have been made with time-domain IP.

(2) General theory of the IP effect. The origin of induced electrical polarization is complex and is not well understood. This is primarily because several physiochemical phenomena and conditions are likely responsible for its occurrence. Only a fairly simple discussion will be given here. According to Seigel (1970), when a metal

electrode is immersed in a solution of ions of a certain concentration and valence, a potential difference is established between the metal and the solution sides of the interface. This difference in potential is an explicit function of the ion concentration, valence, etc. When an external voltage is applied across the interface, a current is caused to flow and the potential drop across the interface changes from its initial value. The change in interface voltage is called the 'overvoltage' or 'polarization' potential of the electrode. Overvoltages are due to an accumulation of ions on the electrolyte side of the interface, waiting to be discharged. The time constant of buildup and decay is typically several tenths of a second.

(a) Overvoltage is therefore established whenever current is caused to flow across an interface between ionic and electronic conduction. In normal rocks the current which flows under the action of an applied emf does so by ionic conduction in the electrolyte in the pores of the rock. There are, however, certain minerals which have a measure of electronic conduction (almost all the metallic sulfides (except sphalerite) such as pyrite, graphite, some coals, magnetite, pyrolusite, native metals, some arsenides, and other minerals with a metallic lustre). Figure 4-18 is a simplified representation of how overvoltages are formed on an electronic conducting particle in an electrolyte under the influence of current flow.



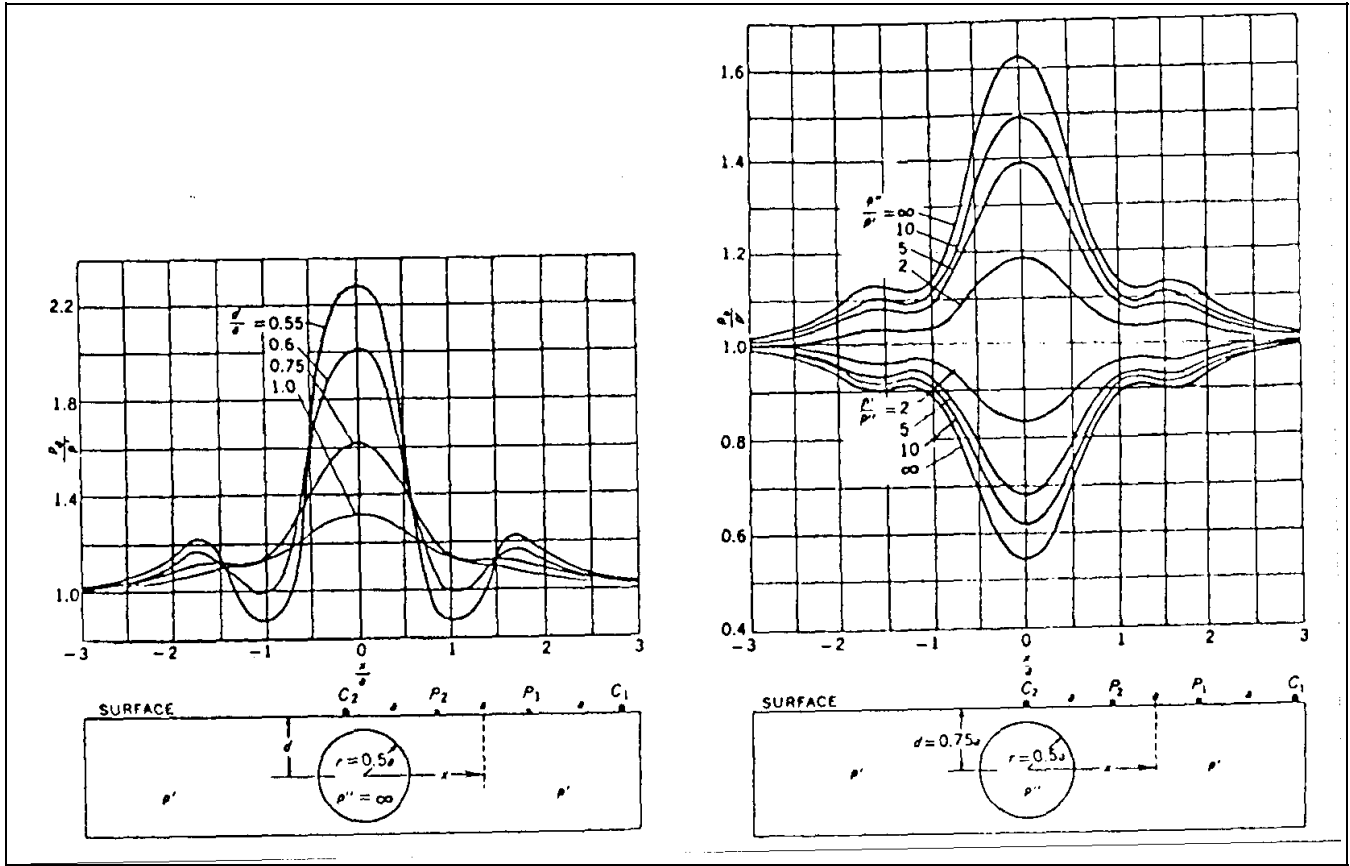

Figure 4-17. Theoretical Wenner profiles across a buried circular cylinder: (a) perfectly insulating cylinders at different depths, (b) cylinders of different resistivity contrasts (Van Nostrand and Cook 1966)

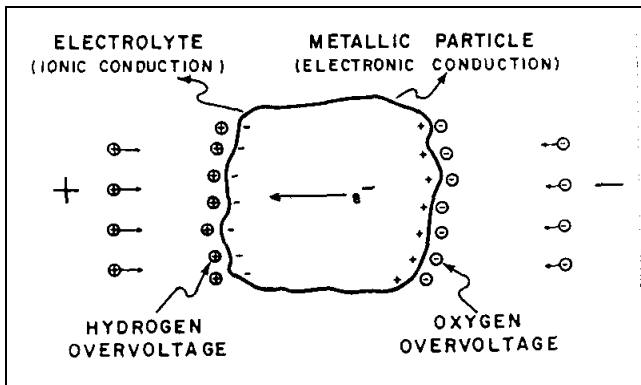

Figure 4-18. Overvoltage on a metallic particle in electrolyte (Seigel 1970; copyright permission granted by Geological Survey of Canada)

(b) The most important sources of nonmetallic IP in rocks are certain types of clay minerals (Vacquier 1957, Seigel 1970). These effects are believed to be related to electro dialysis of the clay particles. This is only one type of phenomenon which can cause 'ion-sorting' or

'membrane effects.' For example, Figure 4-19 shows a cation-selective membrane zone in which the mobility of the cation is increased relative to that of the anion, causing ionic concentration gradients and therefore polarization.

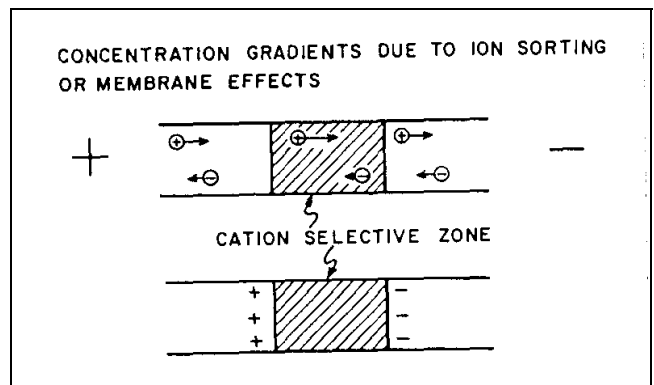

Figure 4-19. Nonmetallic induced polarization agent (Seigel 1970; copyright permission granted by Geological Survey of Canada)

A second group of phenomena includes electrokinetic effects which produce voltage gradients through the 'streaming potential' phenomenon. These voltage gradients will have the same external appearance as polarization effects due to separation of charge. Electrokinetic effects seem less important than membrane effects in the overall polarization picture.

(c) In time-domain IP, several indices have been used to define the polarizability of the medium. Seigel (1959) defined "chargeability" (in seconds) as the ratio of the area under the decay curve (in millivolt-seconds, mV-s) to the potential difference (in mV) measured before switching the current off. Komarov et al. (1966) define "polarizability" as the ratio of the potential difference after a given time from switching the current off to the potential difference before switching the current off. Polarizability is expressed as a percentage.

(d) Seigel (1959) showed that over a heterogeneous medium comprised of  $n$  different materials, apparent chargeability  $\eta_a$  is approximately related to apparent resistivity by

$$\eta_a = \sum_{i=1}^n \eta_i \frac{\partial \log \rho_a}{\partial \log \rho_i} \quad (4-16)$$

where

$\eta_i$  = chargeability of the  $i$ th material

$\rho_i$  = resistivity of the  $i$ th material

Seigel provided the validity of

$$\sum_{i=1}^n \frac{\partial \log \rho_a}{\partial \log \rho_i} = 1 \quad (4-17)$$

Equations 4-16 and 4-17 yield the useful formula:

$$\frac{\eta_a}{\eta_1} = 1 + \sum_{i=2}^n \frac{\partial \log \rho_a}{\partial \log \rho_i} \left[ \frac{\eta_i}{\eta_1} - 1 \right] \quad (4-18)$$

If the theoretical expression for apparent resistivity  $\rho_a$  is known, then the corresponding expression for the reduced apparent chargeability  $\eta_a/\eta_i$  can be derived.

*b. Sounding and profiling.* The techniques of sounding and profiling, used in resistivity measurements, are also used in the IP method. IP soundings are most

commonly made using the Schlumberger array, pole-dipole array, or Wenner array, and usually in the time domain. The apparent chargeability  $\eta_a$  versus the electrode spacing  $a$  is plotted on logarithmic coordinates. The IP sounding curve is an interpreted curve matching procedures, either graphically, using sets of IP sounding master curves, or by computer. At present, only a few two-layer master curves (for the Wenner array) have been published in the United States (Seigel 1959; Frische and von Buttlar 1957). Three- and four-layer curves have been published in the Soviet Union.

(1) An IP sounding curve can be of significant value in complementing a resistivity sounding curve. For example, the resistivity and IP sounding curves for the following four-layer geoelectric section are shown in Figure 4-20:

Layer No.	Thickness (m)	Resistivity ( $\Omega$ m)	Chargeability (s)
1	10	10	1
2	10	160	1
3	5	40	10
4	$\infty$	$\infty$	1

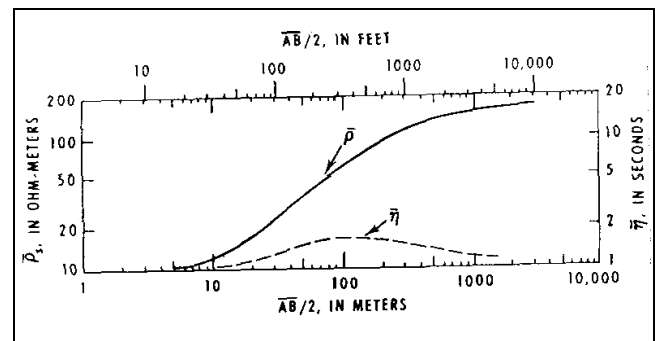

Figure 4-20. Apparent resistivity and apparent chargeability (IP) sounding curves for a four-layer model (Zohdy 1974a, 1974b)

It is obvious that layer 3 cannot be distinguished on the four-layer resistivity curve (which resembles a two- or three-layer curve). But layer 3 is characterized by a different chargeability from the surrounding layers and its presence is indicated clearly by the IP sounding curve.

(2) When profiling, the pole-dipole or dipole-dipole (see Figure 4-21) arrays are used almost exclusively. It can be easily employed in the field using short lengths of

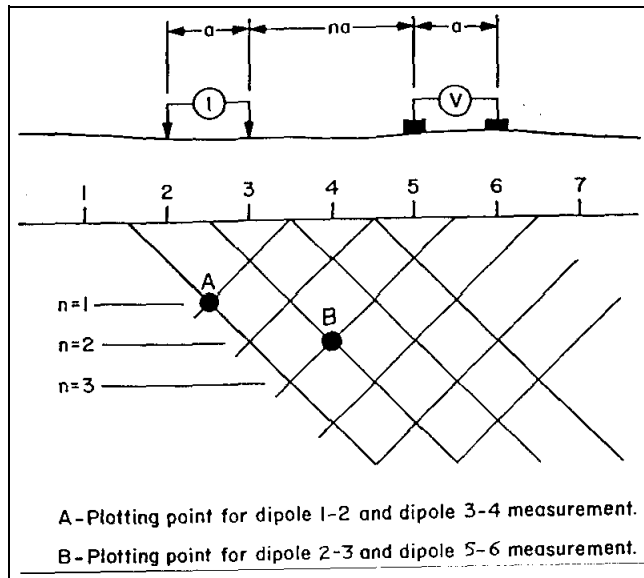

Figure 4-21. Dipole-dipole plotting method

wire or multi-conductor cables allowing several values of the spacing multiplier ( $n$ ) to be measured from one current dipole location. For one or two values of  $n$ , the IP and resistivity results are plotted as profiles. For more than two values of  $n$ , the profile method of presentation becomes confusing. A two-dimensional (usually called pseudosection) format has been developed to present the data (Figure 4-21). This form of presentation helps the interpreter separate the effects of IP and resistivity variations along the line from vertical variations. The 45-deg angle used to plot the data is entirely arbitrary. The pseudosection plots are contoured, and the resulting anomalous patterns can be recognized as being caused by a particular source geometry and/or correlated from line to line. However, "the contoured data are MOST EMPHATICALLY NOT meant to represent sections of the electrical parameters of the subsurface" (Halof 1980). The pseudosection data plots are merely a convenient method for showing all of the data along one given line in one presentation. It cannot be overemphasized that PSEUDOSECTION PLOTS ARE NOT CROSS SECTIONS. Although several commercial IP and resistivity modeling programs are available, trying to model every variation in a pseudosection is not recommended.

(3) Examples.

(a) Example 1 - Groundwater exploration. The majority of published case histories using IP surveys have been for mining exploration, but those treating groundwater exploration is growing: Vacquier et al. (1957),

Kuzmina and Ogil'vi (1965), Bodmer et al. (1968), and Sternberg et al. (1990). Kuzmina and Ogil'vi reported on work done near the Sauk-Soo River in Crimea and in the Kalinino region of Armenia. In Crimea the IP work consisted essentially of IP sounding (time domain) using the Wenner array. The alluvial deposits in the studied area were poorly differentiated by their resistivities, but three horizons were clearly distinguished by their polarizabilities (Figure 4-22). The section consisted of a top layer of weak polarizability ( $h_1 = 2-4$  m;  $\eta_1 = 0.8-1.5\%$ ), which represents a dry loamy layer; a second layer of strong polarizability ( $h_2 = 18-20$  m;  $\eta_2 = 3-5\%$ ), which represented a clayey sand layer saturated with fresh water; and a third layer of weak polarizability ( $h_3$  very thick;  $\eta_3 = 1\%$ ) which represents impervious siltstones. The survey in this area demonstrates that the IP work provided more complete information about the groundwater occurrence than did the resistivity soundings alone.

(b) Example 2 - detection of metal pipes and cables. Zhang and Luo (1990) show model experiments and analytical results which show that, in certain circumstances, a buried metal pipe or armored cable can introduce anomalies in IP (and apparent resistivity) with large amplitude and wide range. These results are important for two reasons. The first is that such man-made features have the potential to cause "noise" or errors in electrical surveys. The general rule of thumb when planning a survey is to orient soundings and profiles as nearly perpendicular to any known buried pipes or cables as the field conditions allow. The obvious second reason for the importance of this paper is that the IP may be used to locate a pipe or cable. Figure 4-23 (Zhang and Luo 1990) shows results of an IP survey using the gradient array in Baima, China. An  $\eta_a$  anomaly of  $\pm 10$  to 3 percent with a width of more than 200 m was obtained near the road (the dot-and-dash lines on the figure). This anomaly can be traced for 4 km along the road. The trend of the anomalies is basically consistent with road and independent of the stratum strike or structural direction within the prospect area. Apparently, it results from a buried communication cable along the highway rather than geological features. The apparent resistivity profiles (the dot-and-double-dash lines on the figure) also appear to correlate with the cable, but with much less consistency or amplitude.

(c) Example 3 - mapping soil and groundwater contamination. Cahyna, Mazac, and Vendhodova (1990) show a valuable IP example used to determine the slag-type material containing cyanide complexes which have contaminated groundwater in Czechoslovakia. Figure 4-24 shows contours of  $\eta_a$  (percent) obtained from a

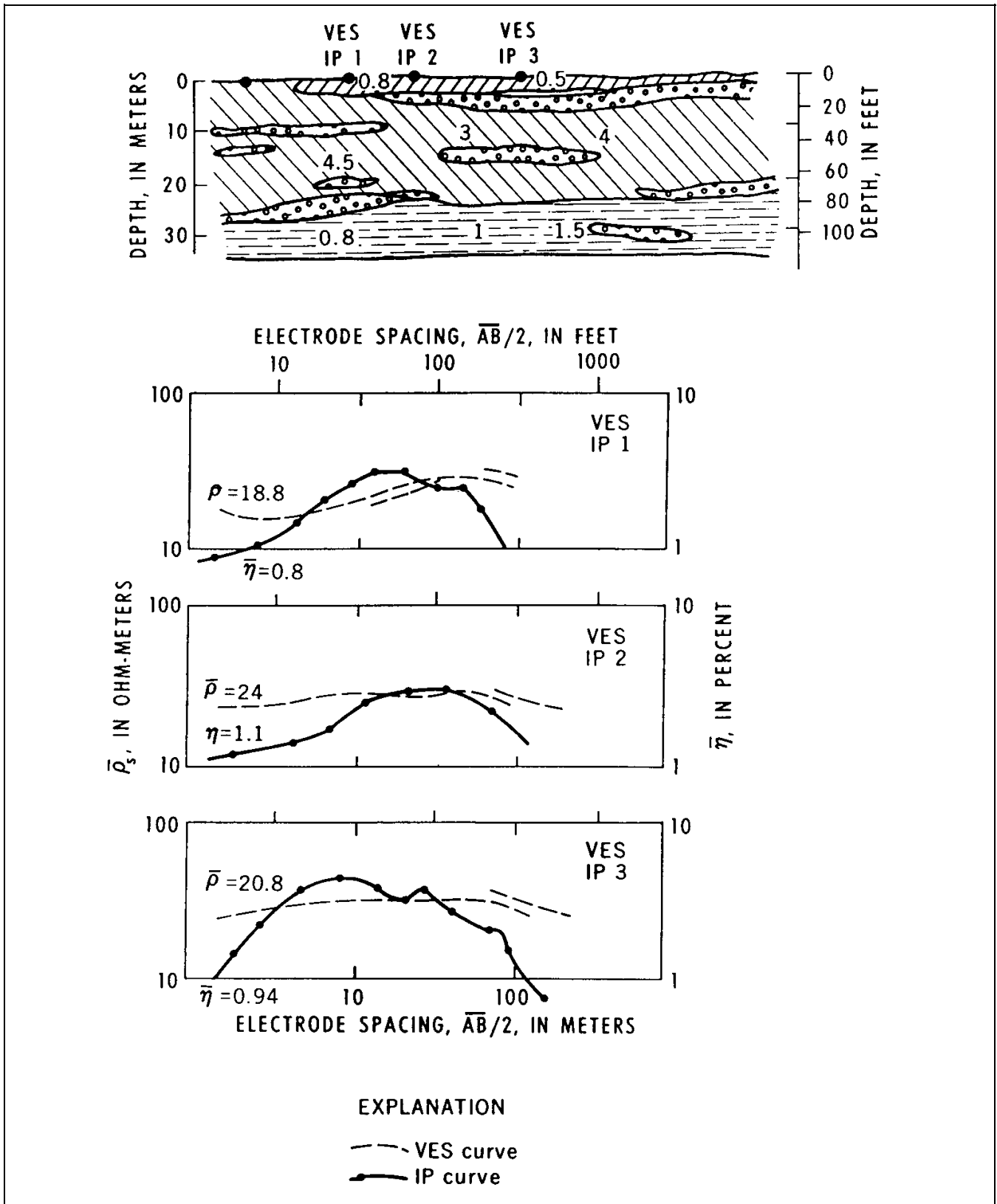

Figure 4-22. Geoelectric section, VES and IP sounding curves of alluvial deposits (Zohdy 1974b)

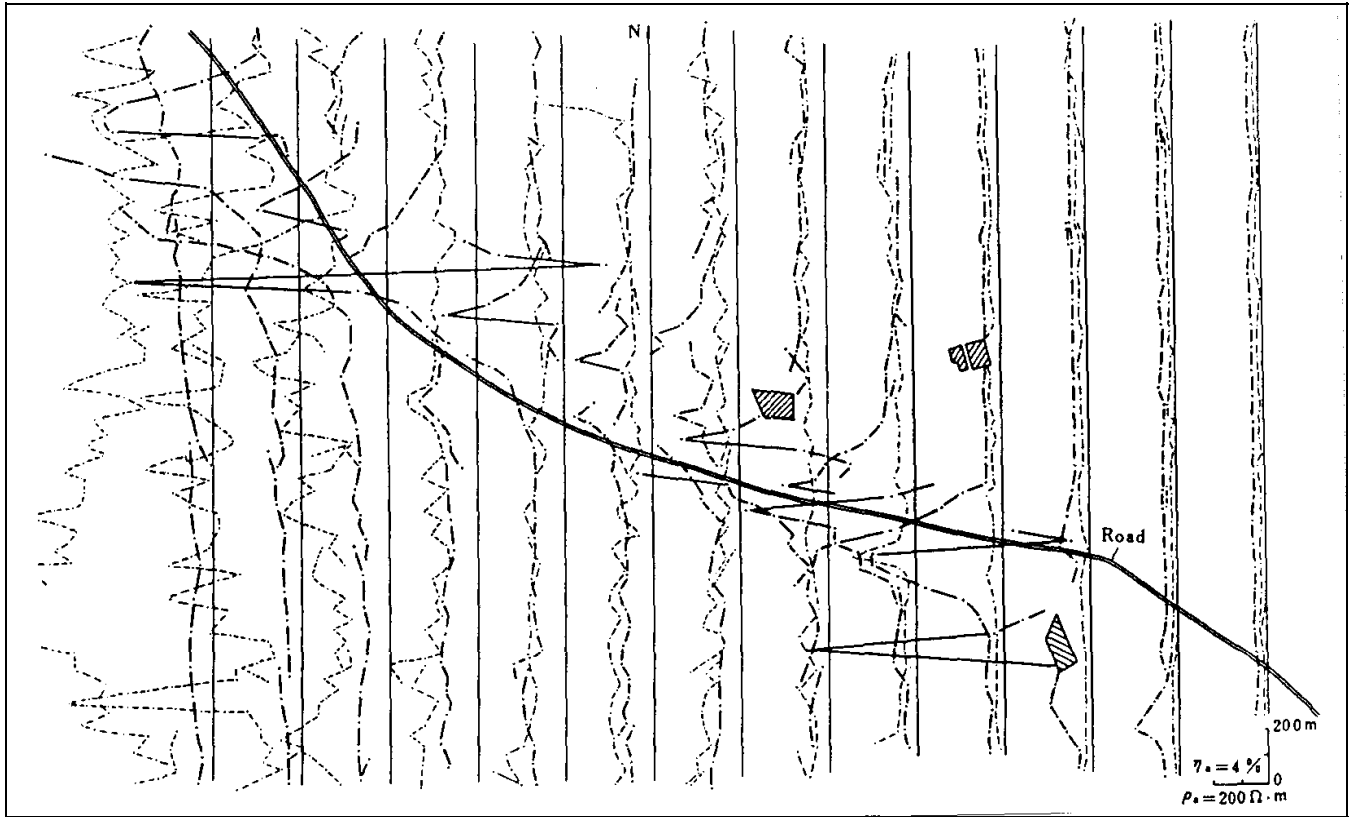

Figure 4-23. Plan profiles for  $\eta_a$  and  $\rho_a$  using the gradient array in Baima, China, over a buried cable (Zhang and Luo 1990; copyright permission granted by Society of Exploration Geophysicists)

10-m grid of profiles. The largest IP anomaly ( $\eta_a = 2.44$  percent) directly adjoined the area of the outcrop of the contaminant (labeled A). The hatched region exhibits polarizability over 1.5 percent and probably represents the maximum concentration of the contaminant. The region exhibiting polarizability of less than 0.75 percent was interpreted as ground free of any slag-type contaminant.

#### 4-6. Time-Domain Electromagnetic Techniques for Resistivity Sounding

*a. General.* Conventional DC resistivity techniques (Section 4-4) have been applied for many years to a variety of geotechnical applications. More recently, electromagnetic techniques, with different advantages (and disadvantages) compared with conventional DC, have been used effectively to measure the resistivity (or its reciprocal, the conductivity) of the earth.

(1) Electromagnetic techniques can be broadly divided into two groups. In frequency-domain instrumentation (FDEM), the transmitter current varies sinusoidally

with time at a fixed frequency which is selected on the basis of the desired depth of exploration of the measurement (high frequencies result in shallower depths). FDEM instrumentation is described in Sections 4-7 through 4-11. In most time-domain (TDEM) instrumentation, on the other hand, the transmitter current, while still periodic, is a modified symmetrical square wave, as shown in Figure 4-25. It is seen that after every second quarter-period the transmitter current is abruptly reduced to zero for one quarter period, whereupon it flows in the opposite direction.

(2) A typical TDEM resistivity sounding survey configuration is shown in Figure 4-26, where it is seen that the transmitter is connected to a square (usually single turn) loop of wire laid on the ground. The side length of the loop is approximately equal to the desired depth of exploration except that, for shallow depths (less than 40 m) the length can be as small as 5 to 10 m in relatively resistive ground. A multi-turn receiver coil, located at the center of the transmitter loop, is connected to the receiver through a short length of cable.

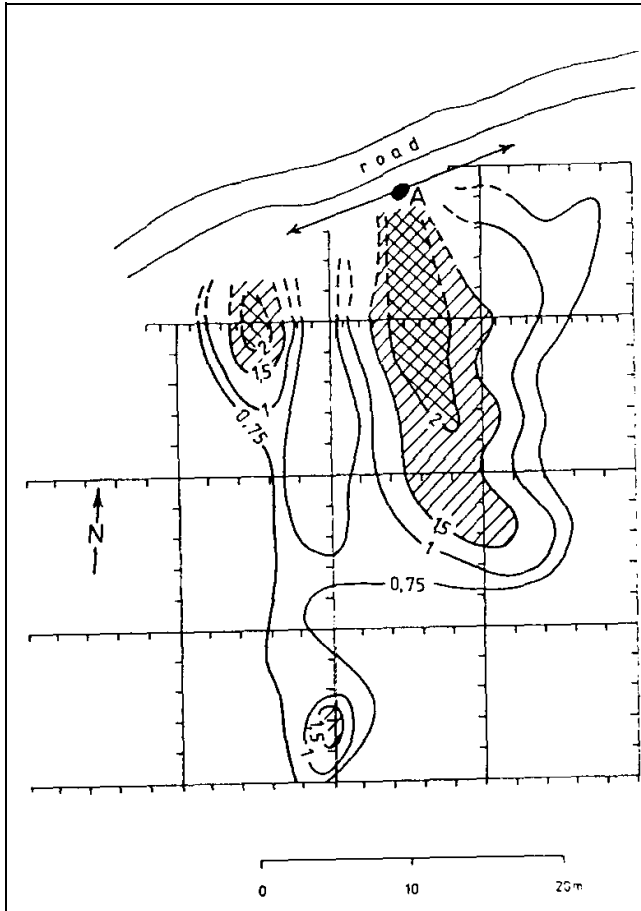

Figure 4-24. Network of SRP-IP profiles with the contours of IP values  $\eta_s$ (percent) and the extent of the contaminant interpreted on the basis of the geophysical survey; location A is the known outcrop of the slag-type contaminant and the position of the VES-IP measurement (Cahyna, Mazac, and Vendhodova 1990; copyright permission granted by Society of Exploration Geophysicists)

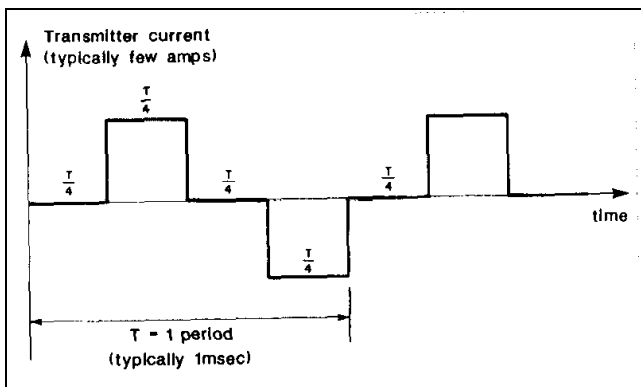

Figure 4-25. Transmitter current wave form

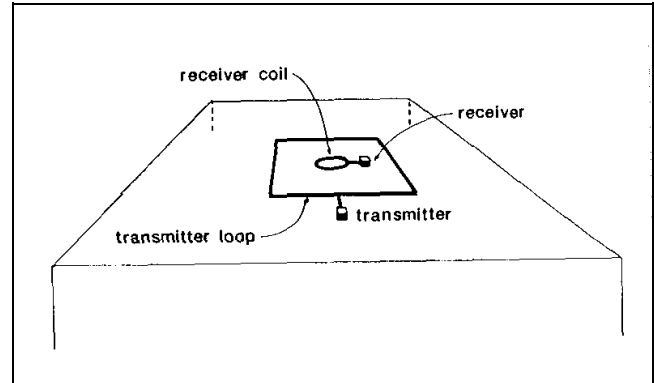

Figure 4-26. Central loop sounding configuration

(3) The principles of TDEM resistivity sounding are relatively easily understood. The process of abruptly reducing the transmitter current to zero induces, in accord with Faraday's law, a short-duration voltage pulse in the ground, which causes a loop of current to flow in the immediate vicinity of the transmitter wire, as shown in Figure 4-27. In fact, immediately after transmitter current is turned off, the current loop can be thought of as an image in the ground of the transmitter loop. However, because of finite ground resistivity, the amplitude of the current starts to decay immediately. This decaying current similarly induces a voltage pulse which causes more current to flow, but now at a larger distance from the transmitter loop, and also at greater depth, as shown in Figure 4-27. This deeper current flow also decays due to finite resistivity of the ground, inducing even deeper current flow and so on. The amplitude of the current flow as a function of time is measured by measuring its decaying magnetic field using a small multi-turn receiver coil usually located at the center of the transmitter loop. From the above it is evident that, by making measurement of the voltage out of the receiver coil at successively later

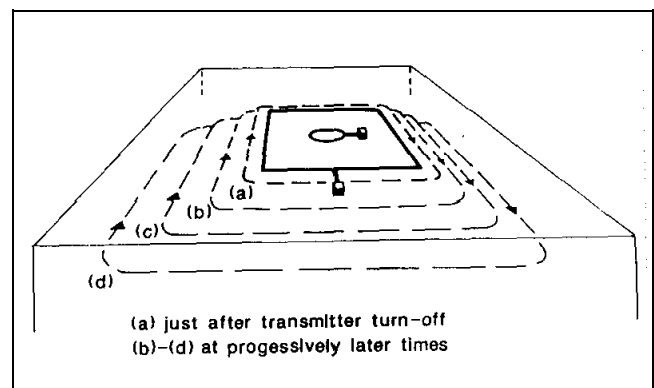

Figure 4-27. Transient current flow in the ground

times, measurement is made of the current flow and thus also of the electrical resistivity of the earth at successively greater depths. This process forms the basis of central loop resistivity sounding in the time domain.

(4) The output voltage of the receiver coil is shown schematically (along with the transmitter current) in Figure 4-28. To accurately measure the decay characteristics of this voltage the receiver contains 20 narrow time gates (indicated in Figure 4-29), each opening sequentially to measure (and record) the amplitude of the decaying voltage at 20 successive times. Note that, to minimize distortion in measurement of the transient voltage, the early time gates, which are located where the transient voltage is changing rapidly with time, are very narrow, whereas the later gates, situated where the transient is varying more slowly, are much broader. This technique is desirable since wider gates enhance the signal-to-noise ratio, which becomes smaller as the amplitude of the transient decays at later times. It will be noted from Figure 4-28 that there are four receiver voltage transients generated during each complete period (one positive pulse plus one negative pulse) of transmitter current flow. However, measurement is made only of those two transients that occur when the transmitter current has just been shut off, since in this case accuracy of the measurement is not affected by small errors in location of the receiver coil. This feature offers a very significant advantage over FDEM measurements, which are generally very sensitive to variations in the transmitter coil/receiver coil spacing since the FDEM receiver measures while the transmitter current is flowing. Finally, particularly for shallower sounding, where it is not necessary to measure the transient characteristics out to very late times, the period is typically of the order of 1 msec or less, which means

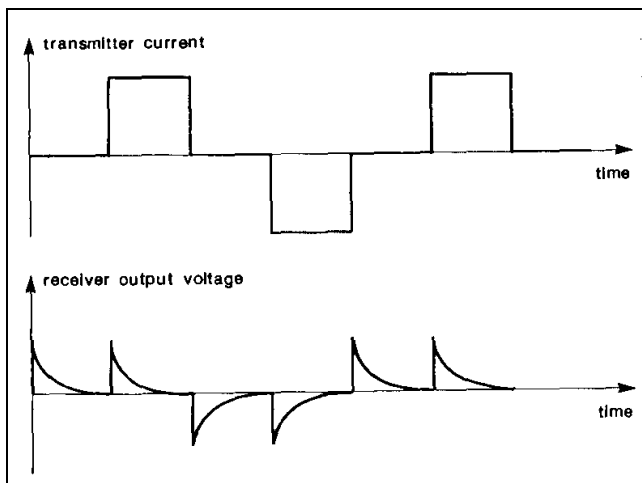

Figure 4-28. Receiver output wave form

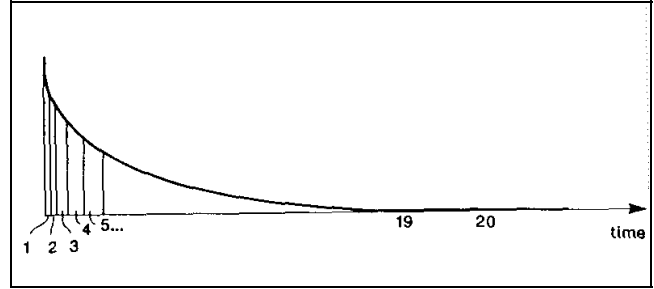

Figure 4-29. Receiver gate locations

that in a total measurement time of a few seconds, measurement can be made and stacked on several thousand transient responses. This is important since the transient response from one pulse is exceedingly small and it is necessary to improve the signal-to-noise ratio by adding the responses from a large number of pulses.

*b. Apparent resistivity in TDEM soundings.*

(1) Figure 4-29 shows, schematically, a linear plot of typical transient response from the earth. It is useful to examine this response when plotted logarithmically against the logarithm of time, particularly if the earth is homogeneous (i.e. the resistivity does not vary with either lateral distance or depth). Such a plot is shown in Figure 4-30, which suggests that the response can be divided into an early stage (where the response is constant with time), an intermediate stage (response shape continually varying with time), and a late stage (response is now a straight line on the log-log plot). The response is generally a mathematically complex function of conductivity and time; however, during the late stage, the mathematics simplifies considerably and it can be shown that during this time the response varies quite simply with time and conductivity as

$$e(t) = \frac{k_1 M \sigma^{3/2}}{t^{5/2}} \tag{4-19}$$

where

$e(t)$  = output voltage from a single-turn receiver coil of area  $1 \text{ m}^2$

$k_1$  = a constant

$M$  = product of Tx current x area ( $\text{a-m}^2$ )

$\sigma$  = terrain conductivity (siemens/m =  $\text{S/m} = 1/\Omega\text{m}$ )

$t$  = time (s)

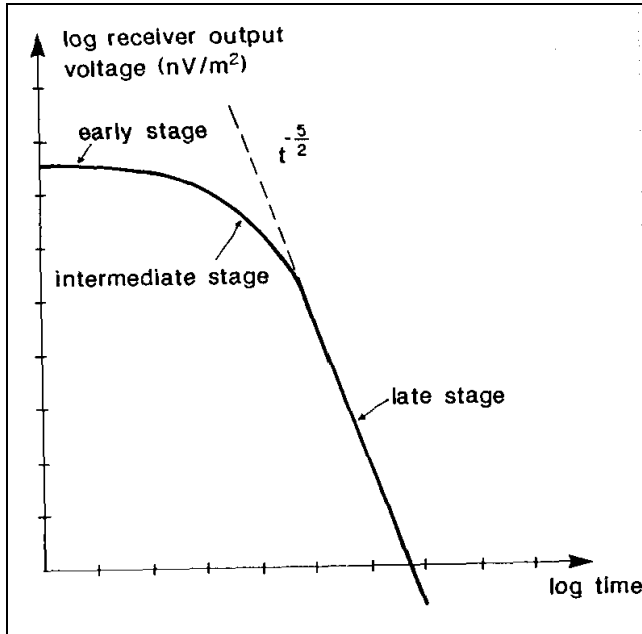

Figure 4-30. Log plot-receiver output voltage versus time (one transient)

(2) Unlike the case for conventional resistivity measurement, where the measured voltage varies linearly with terrain resistivity, for TDEM, the measured voltage  $e(t)$  varies as  $\sigma^{3/2}$ , so it is intrinsically more sensitive to small variations in the conductivity than conventional resistivity. Note that during the late stage, the measured voltage is decaying at the rate  $t^{-5/2}$ , which is very rapidly with time. Eventually the signal disappears into the system noise and further measurement is impossible. This is the maximum depth of exploration for the particular system.

(3) With conventional DC resistivity methods, for example the commonly used Wenner array, the measured voltage over a uniform earth from Equation 4-8 can be shown to be

$$V(a) = \rho I / 2\pi a \quad (4-20)$$

where

$a$  = interelectrode spacing (m)

$\rho$  = terrain resistivity ( $\Omega\text{m}$ )

$I$  = current into the outer electrodes

$V(a)$  = voltage measured across the inner electrodes for the specific value of  $a$

In order to obtain the resistivity of the ground, Equation 4-20 is rearranged (inverted) to give Equation 4-11:

$$\rho = 2\pi a V(a) / I$$

If ground resistivity is uniform as the interelectrode spacing ( $a$ ) is increased, the measured voltage increases directly with  $a$  so that the right-hand side of Equation 4-11 stays constant, and the equation gives the true resistivity. Suppose now that the ground is horizontally layered (i.e. that the resistivity varies with depth); for example it might consist of an upper layer of thickness  $h$  and resistivity  $\rho_1$ , overlying a more resistive basement of resistivity  $\rho_2 > \rho_1$ , (this is called a two-layered earth). At very short interelectrode spacing ( $a \ll h$ ) virtually no current penetrates into the more resistive basement and resistivity calculation from Equation 4-11 will give the value  $\rho_1$ . As interelectrode spacing is increased, the current ( $I$ ) is forced to flow to greater and greater depths. Suppose that, at large values of  $a$  ( $a \gg h$ ), the effect of the near surface material of resistivity  $\rho_1$  will be negligible, and resistivity calculated from Equation 4-11 will give the value  $\rho_2$ , which is indeed what happens. At intermediate values of  $a$  ( $a \approx h$ ) the resistivity given by Equation 4-11 will lie somewhere between  $\rho_1$  and  $\rho_2$ .

(4) Equation 4-11 is, in the general case, used to define an apparent resistivity  $\rho_a(a)$  which is a function of  $a$ . The variation of  $a \rho_a(a)$  with  $a$

$$\rho_a(a) = 2\pi a V(a) / I \quad (4-21)$$

is descriptive of the variation of resistivity with depth. The behavior of the apparent resistivity  $\rho_a(a)$  for a Wenner array for the two-layered earth above is shown schematically in Figure 4-31. It is clear that in conventional resistivity sounding, to increase the depth of exploration, the interelectrode spacing must be increased.

(5) In the case of TDEM sounding, on the other hand, it was observed earlier that as time increased, the depth to the current loops increased, and this phenomenon is used to perform the sounding of resistivity with depth. Thus, in analogy with Equation 4-21, Equation 4-19 is inverted to read (since  $\rho = 1/\sigma$ )

$$\rho_a(t) = \frac{k_2 M^{2/3}}{e(t)^{2/3} t^{5/3}} \quad (4-22)$$

(a) Suppose once again that terrain resistivity does not vary with depth (i.e. a uniform half-space) and is of



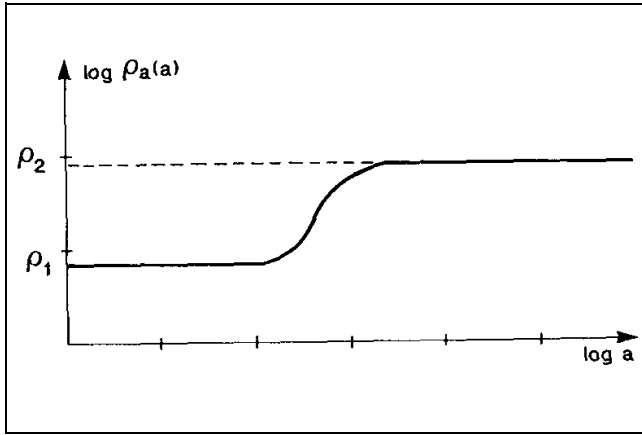

Figure 4-31. Wenner array: apparent resistivity, two-layer curve

resistivity  $\rho_1$ . For this case, a plot of  $\rho_a(t)$  against time would be as shown in Figure 4-32. Note that at late time the apparent resistivity  $\rho_a(t)$  is equal to  $\rho_1$ , but at early time  $\rho_a(t)$  is much larger than  $\rho_1$ . The reason for this is that the definition of apparent resistivity is based (as seen from Figure 4-30) on the time behavior of the receiver coil output voltage at late time when it decays as  $t^{-5/2}$ . At earlier and intermediate time, Figure 4-30 shows that the receiver voltage is too low (the dashed line indicates the voltage given by the "late stage approximation") and thus, from Equation 4-22, the apparent resistivity will be too high. For this reason, there will always be, as shown on Figure 4-32, a "descending branch" at early time where the apparent resistivity is higher than the half-space resistivity (or, as will be seen later, is higher than the upper layer resistivity in a horizontally layered earth). This is not a problem, but it is an artifact of which we must be aware.

(b) Suppose that once again, we let the earth be two-layered, of upper layer resistivity  $\rho_1$ , and thickness  $h$ , and basement resistivity  $\rho_2 (>\rho_1)$ . At early time when the currents are entirely in the upper layer of resistivity  $\rho_1$  the decay curve will look like that of Figure 4-30, and the apparent resistivity curve will look like Figure 4-32. However, later on the currents will lie in both layers, and at much later time they will be located entirely in the basement, of resistivity  $\rho_2$ . Since  $\rho_2 > \rho_1$ , Equation 4-22 shows that, as indicated in Figure 4-33a, the measured voltage will now be less than it should have been for the homogeneous half-space of resistivity  $\rho_1$ . The effect on the apparent resistivity curve is shown in Figure 4-34a; since at late times all the currents are in the basement, the apparent resistivity  $\rho_a(t)$  becomes equal to  $\rho_2$ , completely

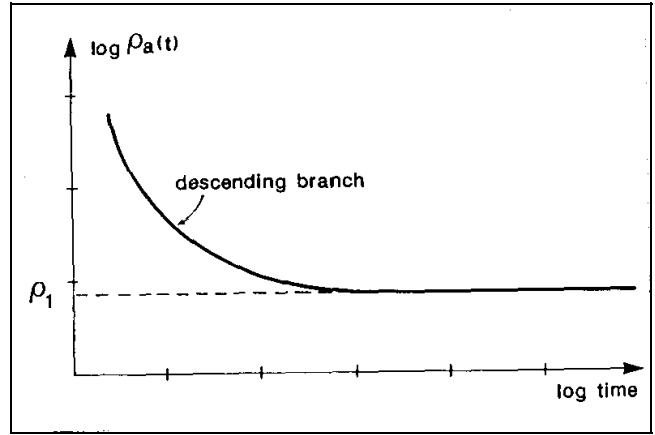

Figure 4-32. TDEM: apparent resistivity, homogenous half-space

in analogy for Figure 4-31 for conventional resistivity measurements. In the event that  $\rho_2 < \rho_1$ , the inverse behavior is also as expected, i.e. at late times the measured voltage response, shown in Figure 4-33, is greater than that from a homogeneous half-space of resistivity  $\rho_1$ , and the apparent resistivity curve correspondingly becomes that of Figure 4-34b, becoming equal to the new value of  $\rho_2$  at late time. Note that, for the case of a (relatively) conductive basement there is a region of intermediate time (shown as  $t^*$ ), where the voltage response temporarily falls before continuing on to adopt the value appropriate to  $\rho_2$ . This behavior, which is a

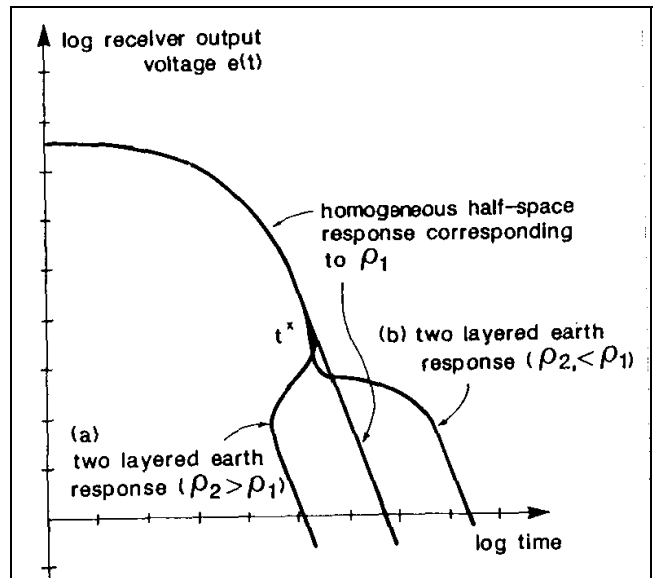
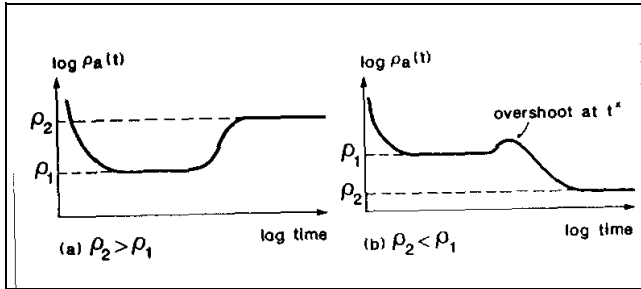

Figure 4-33. TDEM: receiver output voltage, two-layered earth



**Figure 4-34. TDEM: apparent resistivity, two-layered earth**

characteristic of TDEM, is again not a problem, as long as it is recognized. The resultant influence of the anomalous behavior on the apparent resistivity is also shown on Figure 4-34b at  $t^*$ .

(c) To summarize, except for the early-time descending branch and the intermediate-time anomalous region described above, the sounding behavior of TDEM is analogous to that of conventional DC resistivity if the passage of time is allowed to achieve the increasing depth of exploration rather than increasing interelectrode spacing.

(6) Curves of apparent resistivity such as Figure 4-34 tend to disguise the fact, that, at very late times, there is simply no signal, as is evident from Figure 4-33. In fact in the TDEM central loop sounding method it is unusual to see, in practical data, the curve of apparent resistivity actually asymptote to the basement resistivity, due to loss of measurable signal. Fortunately, both theoretically and in practice, the information about the behavior of the apparent resistivity curve at early time and in the transition region is generally sufficient to allow the interpretation to determine relatively accurately the resistivity of the basement without use of the full resistivity sounding curve.

*c. Measurement procedures.* As stated in Section 1 a common survey configuration consists of a square single turn loop with a horizontal receiver coil located at the center. Data from a resistivity sounding consist of a series of values of receiver output voltage at each of a succession of gate times. These gates are located in time typically from a few microseconds up to tens or even hundreds of milliseconds after the transmitter current has been turned off, depending on the desired depth of exploration. The receiver coil measures the time rate of change of the magnetic field  $e(t)=dB/dt$ , as a function of time during the transient. Properly calibrated, the units of  $e(t)$  are  $V/m^2$  of receiver coil area; however, since the

measured signals are extremely small it is common to use  $nV/m^2$ , and measured decays typically range from many thousands of  $nV/m^2$  at early times to less than  $0.1 nV/m^2$  at late times. Modern receivers are calibrated in  $nV/m^2$  or  $V/m^2$ . To check the calibration, a "Q-coil," which is a small short-circuited multi-turn coil laid on the ground at an accurate distance from the receiver coil is often used, so as to provide a transient signal of known amplitude.

(1) The two main questions in carrying out a resistivity sounding are (a) how large should the side lengths of the (usually single-turn) transmitter be, and (b) how much current should the loop carry? Both questions are easily answered by using one of the commercially available forward layered-earth computer modelling programs. A reasonable guess as to the possible geoelectric section (i.e. the number of layers, and the resistivity and thickness of each) is made. These data are then fed into the program, along with the proposed loop size and current, and the transient voltage is calculated as a function of time. For example, assume that it is suspected that a clay aquitard may exist at a depth of 20 m in an otherwise clay-free sand. Resistivity of the sand might be  $100 \Omega m$ , and that of the clay layer  $15 \Omega m$ . Desired information includes the minimum thickness of the clay layer that is detectable, and the accuracy with which this thickness can be measured. The depth of exploration is of the order of the loop edge size, so  $10 m \times 10 m$  represents a reasonable guess for model calculation, along with a loop current of 3 A, which is characteristic of a low-power, shallow-depth transmitter. Before doing the calculations, one feature regarding the use of small (i.e. less than  $60 m \times 60 m$ ) transmitter loops for shallow sounding should be noted. In these small loops the inducing primary magnetic field at the center of the loop is very high, and the presence of any metal, such as the receiver box, or indeed the shielding on the receiver coil itself, can cause sufficient transient response to seriously distort the measured signal from the ground. This effect is greatly reduced by placing the receiver coil (and receiver) a distance of about 10 m outside the nearest transmitter edge. As shown later, the consequence of this on the data is relatively small.

(a) The first task is to attempt to resolve the difference between, for example, a clay layer 0 m thick (no clay) and 1 m thick. Results of the forward layered-earth calculation, shown in Figure 4-35, indicate that the apparent resistivity curves from these two cases are well separated (difference in calculated apparent resistivity is about 10 percent) over the time range from about  $8 \mu s$  to  $100 \mu s$ , as would be expected from the relatively shallow

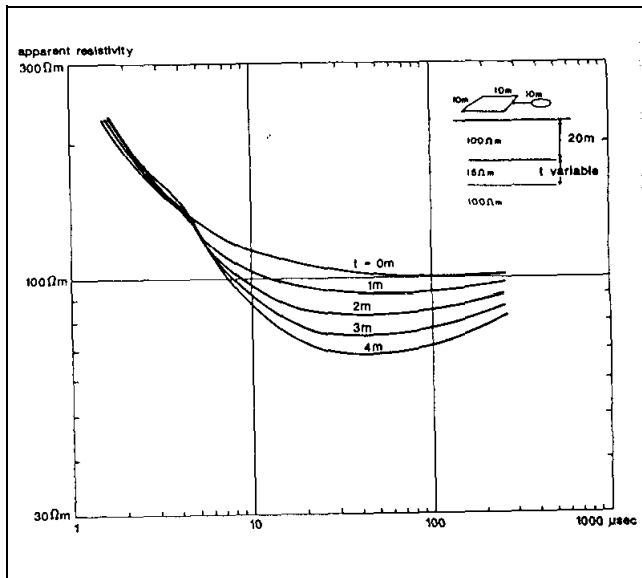

Figure 4-35. Forward layered-earth calculations

depths. Note that, to use this early time information, a receiver is required that has many narrow early time gates in order to resolve the curve, and also has a wide bandwidth so as not to distort the early portions of the transient decay. Note from the figure that resolving thicknesses from 1 to 4 m and greater will present no problem.

(b) Having ascertained that the physics of TDEM sounding will allow detection of this thin layer, the next test is to make sure that the 10- by 10-m transmitter running at 3 A will provide sufficient signal-to-noise over the time range of interest (8 to 100  $\mu$ s). The same forward layered-earth calculation also outputs the actual measured voltages that would be measured from the receiver coil. These are listed (for the case of thickness of 0 m, which will produce the lowest voltage at late times) in Table 4-2. Focus attention on the first column (which gives the time, in seconds) and the third column (which gives the receiver output as a function of time, in  $V/m^2$ ). Now the typical system noise level (almost invariably caused by external noise sources, see Section 4) for gates around 100 to 1,000  $\mu$ s is about 0.5  $nV/m^2$  or  $5 \times 10^{-10} V/m^2$ . From columns 1 and 3 see that, for the model chosen, the signal falls to  $5 \times 10^{-10} V/m^2$  at a time of about 630  $\mu$ s and is much greater than this for the early times when the apparent resistivity curves are well-resolved, so it is learned that the 10-m by 10-m transmitter at 3 A is entirely adequate. In fact, if a 5-m by 5-m transmitter was used, the dipole moment (product of transmitter current and area) would fall by 4, as would the measured signals, and the signal-to-noise ratio would still be excellent over the time range of interest. Thus assured, assum-

ing that the model realistically represents the actual conditions of resistivity, the procedure will be able to detect the thin clay layer. Before proceeding with the actual measurement it would be wise to vary some of the model parameters, such as the matrix and clay resistivities, to see under what other conditions the clay will be detectable. The importance of carrying out such calculations cannot be overstated. The theory of TDEM resistivity sounding is well understood, and the value of such modelling, which is inexpensive and fast, is very high.

(c) It was stated above that offsetting the receiver coil from the center of the transmitter loop would not greatly affect the shape of the apparent resistivity curves. The reason for this is that the vertical magnetic field arising from a large loop of current (such as that shown in the ground at late time in Figure 4-27) changes very slowly in moving around the loop center. Thus, at late time, when the current loop radius is significantly larger than the transmitter loop radius, it would be expected that moving the receiver from the center of the transmitter loop to outside the loop would not produce a large difference, whereas at earlier times when the current loop radius is approximately the same as the transmitter radius, such offset will have a larger effect. This behavior is illustrated in Figure 4-36, which shows the apparent resistivity curves for the receiver at the center and offset by 15 m from the center of the 10- by 10-m transmitter loop. At late time the curves are virtually identical.

(d) How closely spaced should the soundings be? One of the big advantages of TDEM geoelectric sounding over conventional DC sounding is that for TDEM the overall width of the measuring array is usually much less than the depth of exploration, whereas for conventional DC sounding the array dimension is typically (Wenner array) of the order of 3 times the exploration depth. Thus, in the usual event that the terrain resistivity is varying laterally, TDEM sounding will generally indicate those variations much more accurately. If the variations are very closely spaced one might even take measurements at a station spacing of every transmitter loop length. It should be noted that most of the time spent doing a sounding (especially deeper ones where the transmitter loop is large) is utilized in laying out the transmitter loop. In this case, it can be much more efficient to have one or even two groups laying out loops in advance of the survey party, who then follow along with the actual transmitter, receiver, and receiver coil to make the sounding in a matter of minutes, again very favorable compared with DC sounding. A further advantage of TDEM geoelectric sounding is that, if a geoelectric interface is not

**Table 4-2**  
**Forward Response Calculation**

1. Title	:TEST
2. Number of layers	:1
3&4. Thickness & Resistivity	: Thickness [m] Resistivity [Ohmm] INFINITE .100000E+03
5. Source - RECTANGULAR LOOP	: 10.00 × 10.00
6. Point of receiver (XO,YO)	: .000E+00, .150E+02
7. Current in transmitter	: 3.00 [A]
8. Induction numbers	:DEFAULT SELECTION
9. Real time [sec]	:TO= .1000E-05 NT= 5 TM= .1000E-02
10. Field component	:BZ
11. On output file	:TIME DOMAIN
12. Output file name	:X.DAT record 1
13. Turn off time	: 1 [us]
14. Runon correction	:NO
15. Low pass filter correct.	:NO
16. Asymptotic approximation	:TAS= .00000E+00

TIME DOMAIN RESPONSE

Real Time	Tau	dBz/dt	App. Res.	Tau/H1	App./R01
.10000E-05	.79267E+02	.85461E-03	.31459E+03	.79267E+02	.31459E+01
.15849E-05	.99791E+02	.47244E-03	.21679E+03	.99791E+02	.21679E+01
.25119E-05	.12563E+03	.22169E-03	.16663E+03	.12563E+03	.16663E+01
.39811E-05	.15816E+03	.87414E-04	.14384E+03	.15816E+03	.14384E+01
.63096E-05	.19911E+03	.34155E-04	.12492E+03	.19911E+03	.12492E+01
.10000E-04	.25066E+03	.11955E-04	.11674E+03	.25066E+03	.11674E+01
.15849E-04	.31557E+03	.41257E-05	.11014E+03	.31557E+03	.11014E+01
.25119E-04	.39727E+03	.13721E-05	.10650E+03	.39727E+03	.10650E+01
.39811E-04	.50014E+03	.44950E-06	.10402E+03	.50014E+03	.10402E+01
.63096E-04	.62964E+03	.14541E-06	.10246E+03	.62964E+03	.10246E+01
.10000E-03	.79267E+03	.46628E-07	.10151E+03	.79267E+03	.10151E+01
.15849E-03	.99791E+03	.15002E-07	.10035E+03	.99791E+03	.10035E+01
.25119E-03	.12563E+04	.45975E-08	.10247E+03	.12563E+04	.10247E+01
.39811E-03	.15816E+04	.14868E-08	.10094E+03	.15816E+04	.10094E+01
.63096E-03	.19911E+04	.48920E-09	.98312E+02	.19911E+04	.98312E+00
.10000E-02	.25066E+04	.15192E-09	.99507E+02	.25066E+04	.99507E+00

horizontal, but is dipping, the TDEM still gives a reasonably accurate average depth to the interface. Similarly TDEM sounding is much less sensitive (especially at later times) to varying surface topography.

(e) It was explained above that, particularly at later times, the shape of the apparent resistivity curve is relatively insensitive to the location of the receiver coil. This feature is rather useful when the ground might be sufficiently inhomogeneous to invalidate a sounding (in the worst case, for example, due to a buried metallic pipe). In this case a useful and quick procedure is to take several measurements at different receiver locations, as shown in Figure 4-37. Curve 5 is obviously anomalous, and must be rejected. Curves 1-4 can all be used in the inversion process, which handles both central and offset

receiver coils. Another useful way to ensure, especially for deep soundings, that the measurement is free from errors caused by lateral inhomogeneities (perhaps a nearby fault structure) is to use a three- component receiver coil, which measures, in addition to the usual vertical component of the decaying magnetic field, both horizontal components. When the ground is uniform or horizontally layered, the two horizontal components are both essentially equal to zero, as long as the measurement is made near the transmitter loop center (which is why the technique is particularly relative to deep sounding). Departures from zero are a sure indication of lateral inhomogeneities which might invalidate the sounding.

(f) Finally, most receivers, particularly those designed for shallower sounding, have an adjustable base frequency

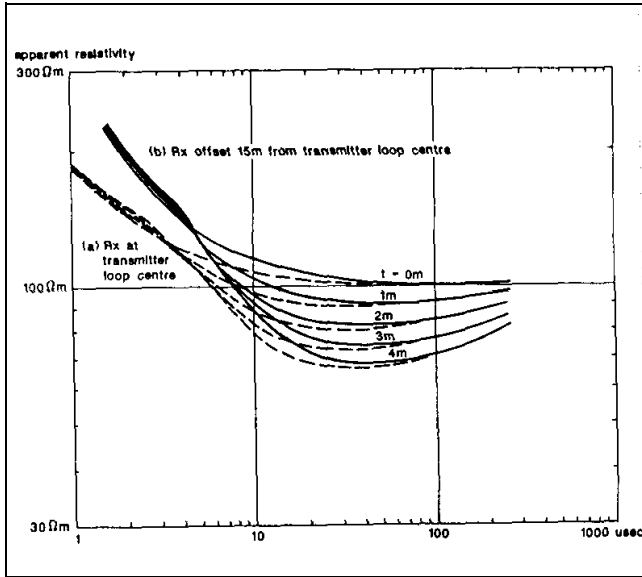

Figure 4-36. Forward layered earth calculations, (a) central loop sounding, (b) offset sounding

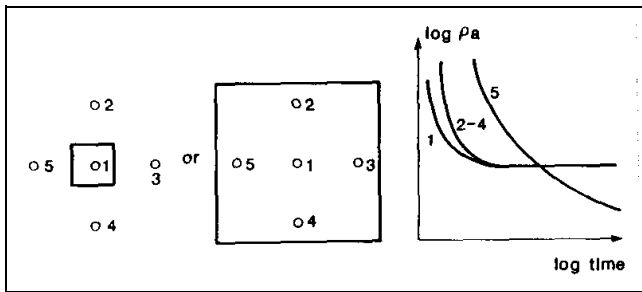

Figure 4-37. Offset Rx locations to check lateral homogeneity, position 5 is near lateral inhomogeneity

to permit changing the length of the measurement time. With reference to Figures 4-25 and 4-28, changing the base frequency  $f_b$  will change the period  $T$  ( $T=1/f_b$ ), and thus the measurement duration  $T/4$ . For transients which decay quickly, such as shallow sounding, the measurement period, which should be of the order of duration of the transient, should be short, and thus the base frequency high. This has the advantage that, for a given total integration time of, say 5 s, more transient responses will be stacked, to improve the signal-to-noise ratio and allow the use of smaller, more mobile, transmitter loops, increasing survey speed. On the other hand, for deep sounding, where the response must be measured out to very long time, it is clear that the measurement period must be greatly extended so that the transient response does not run on to the next primary field cycle or indeed the next transient response, and thus the base frequency must be significantly reduced. The signal-to-noise ratio will

deteriorate due to fewer transients being stacked, and must be increased by either using a larger transmitter loop and transmitter current (to increase the transmitter dipole) and/or integrating the data for a longer stacking time, perhaps for 30 s or even a minute. It should be noted that should such run-on occur because too high a base frequency was employed, it can still be corrected for in modern data inversion programs; however, in extreme cases, accuracy and resolution of the inversion will start to deteriorate.

(2) Finally, both in Figure 4-28 and in this discussion, it was assumed that the transmitter current is turned off instantaneously. To actually accomplish this with a large loop of transmitter wire is impossible, and modern transmitters shut the current down using a very fast linear ramp. The duration of this ramp is maintained as short as possible (it can be shown to have an effect similar to that of broadening the measurement gate widths) particularly for shallow sounding where the transient decays very rapidly at early times. The duration of the transmitter turn-off ramp (which can also be included in modern inversion programs) is usually controlled by transmitter loop size and/or loop current.

d. Sources of noise.

(1) Noise sources for TDEM soundings can be divided into four categories:

- (a) Circuit noise (usually so low in modern receivers as to rarely cause a problem).
- (b) Radiated and induced noise.
- (c) Presence of nearby metallic structures.
- (d) Soil electrochemical effects (induced polarization).

(2) Radiated noise consists of signals generated by radio and radar transmitters and also from thunderstorm lightning activity. The first two are not usually a problem; however, on summer days when there is extensive local thunderstorm activity the electrical noise from lightning strikes (similar to the noise heard on AM car radios) can cause problems and it may be necessary to increase the integration (stacking) time or, in severe cases, to discontinue the survey until the storms have passed by or abated.

(3) The most important source of induced noise consists of the intense magnetic fields from 50- to 60-Hz

power lines. The large signals induced in the receiver from these fields (which fall off more or less linearly with distance from the powerline) can overload the receiver if the receiver gain is set to be too high, and thus cause serious errors. The remedy is to reduce the receiver gain so that overload does not occur, although in some cases this may result in less accurate measurement of the transient since the available dynamic range of the receiver is not being fully utilized. Another alternative is to move the measurement array further from the power line.

(4) The response from metallic structures can be very large compared with the response from the ground. Interestingly, the power lines referred to above can often also be detected as metallic structures, as well as sources of induced noise. In this case they exhibit an oscillating response (the response from all other targets, including the earth, decays monotonically to zero). Since the frequency of oscillation is unrelated to the receiver base frequency, the effect of power line structural response is to render the transient “noisy” as shown in Figure 4-38. Since these oscillations arise from response to eddy currents actually induced in the power line by the TDEM transmitter, repeating the measurement will produce an identical response, which is one way that these oscillators are identified. Another way is to take a measurement with the transmitter turned off. If the “noise” disappears it is a good indication that power-line response is the problem. The only remedy is to move the transmitter further from the power line.

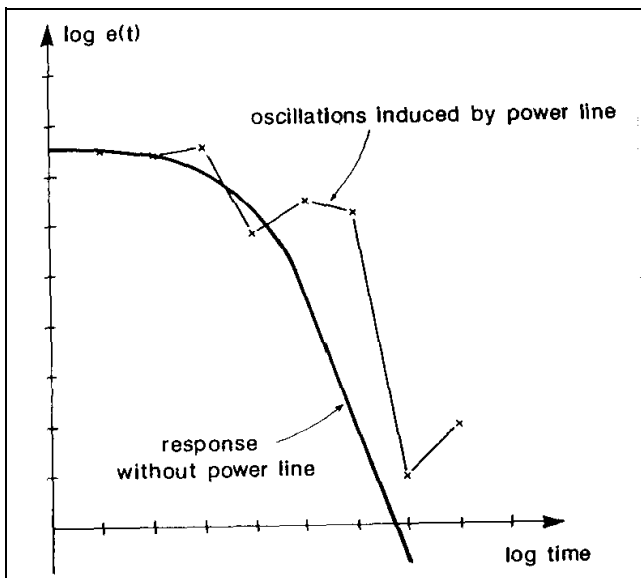

Figure 4-38. Oscillations induced in receiver response by power line

(5) Other metallic responses, such as those from buried metallic trash, or pipes, can also present a problem, a solution for which was discussed in the previous section (multiple receiver sites, as shown in Figure 4-37). If the response is very large, another sounding site must be selected. Application of another instrument such as a metal detector or ground conductivity meter to quickly survey the site for pipes can often prove useful.

(6) A rather rare effect, but one which can occur, particularly in clayey soils, is that of induced polarization. Rapid termination of the transmitter current can charge up the minute electrical capacitors in the soil interfaces (induced polarization). These capacitors subsequently discharge, producing current flow similar to that shown in Figure 4-27, but in the opposite direction. The net effect is to reduce the amplitude of the transient response (thus increasing the apparent resistivity) or even, where the effect is very severe, to cause the transient response to become negative over some range of the measurement time. Since these sources of reverse current are localized near the transmitter loop, using the offset configuration usually reduces the errors caused by them to small values.

(7) In summary, it should be noted that in TDEM soundings the signal-to-noise ratio is usually very good over most of the time range. However, in general the transient response is decaying extremely rapidly (of the order of  $t^{-5/2}$ , or by a factor of about 300 for a factor of 10 increase in time). The result is that towards the end of the transient the signal-to-noise ratio suddenly deteriorates completely and the data become exceedingly noisy. The transient is over!

*e. Data reduction and interpretation.*

(1) In the early days of TDEM sounding, particularly in Russia where the technique was developed (Kaufman and Keller 1983) extensive use was made of numerically calculated apparent resistivity curves for a variety of layered earth geometrics. Field data would be compared with a selection of curves, from which the actual geoelectric section would be determined.

(2) More recently the advent of relatively fast computer inversion programs allows field transient data to be automatically inverted to a layered earth geometry in a matter of minutes. An inversion program offers an additional significant advantage. All electrical sounding techniques (conventional DC, magneto-telluric, TDEM) suffer to a greater or less extent from equivalence, which

basically states that, to within a given signal-to-noise ratio in the measured data, more than one specific geoelectric model will fit the measured data. This problem, which is seldom addressed in conventional DC soundings, is one of which the interpreter must be aware, and the advantage of the inversion program is that, given an estimate of the signal-to-noise ratio in the measured data, the program could calculate a selection of equivalent geoelectric sections that will also fit the measured data, immediately allowing the interpreter to decide exactly how unique his solution really is. Equivalence is a fact of life, and must be included in any interpretation.

*f. Summary.* The advantages of TDEM geoelectric sounding over conventional DC resistivity sounding are significant. They include the following:

- (1) Improved speed of operation.
- (2) Improved lateral resolution.
- (3) Improved resolution of conductive electrical equivalence.
- (4) No problems injecting current into a resistive surface layer.

The disadvantages of TDEM techniques are as follows:

- (5) Do not work well in very resistive material.
- (6) Interpretational material for TDEM on, for example, 3D structures is still under development.
- (7) TDEM equipment tends to be somewhat more costly due to its greater complexity.

As mentioned above, the advantages are significant, and TDEM is becoming a widely used tool for geoelectrical sounding.

#### 4-7. Frequency-Domain Electromagnetic Methods

##### *a. The electromagnetic induction process.*

(1) The electromagnetic induction process is conceptually summarized in Figure 4-39 from Klein and Lajoie (1980). An EM transmitter outputs a time-varying electric current into a transmitter coil. The current in the transmitter coil generates a magnetic field of the same frequency and phase. Lines of force of this magnetic field penetrate the earth and may penetrate a conductive

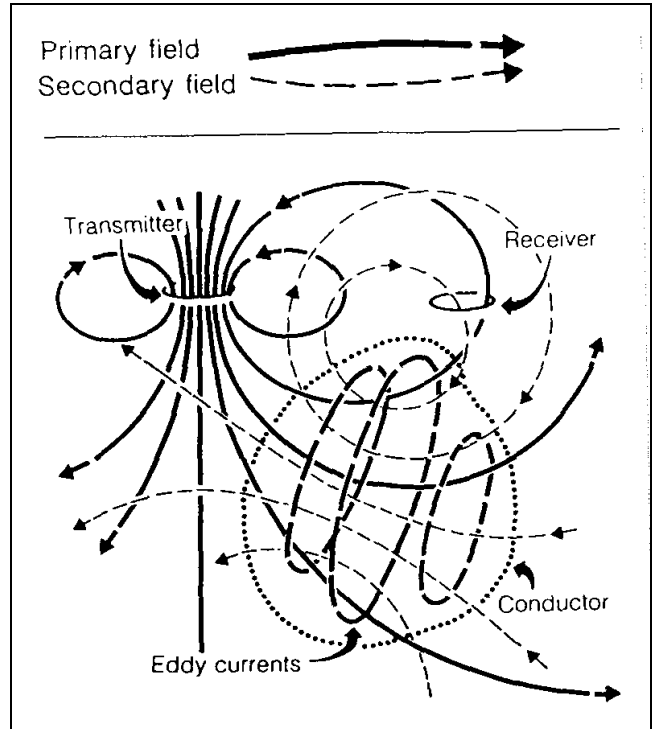

**Figure 4-39. Generalized picture of electromagnetic induction prospecting (Klein and Lajoie 1980; copyright permission granted by Northwest Mining Association and Klein)**

body. When this occurs, an electromotive force or voltage is set up within the conductor, according to Faraday's Law:

$$EMF_c = M_{TC} \frac{dI_T}{dt} \quad (4-23)$$

where

$EMF_c$  = electromotive force or voltage in the conductor

$M_{TC}$  = mutual inductance between the transmitter and the conductive body in the ground (a complex number)

$dI_T/dt$  = time rate of change (derivative) of the current ( $I_T$ ) in the transmitter loop

(2) Current will flow in the conductor in response to the induced electromotive force. These currents will usually flow through the conductor in planes

perpendicular to lines of magnetic field of force from the transmitter, unless restricted by the conductor's geometry. Current flow within the conductor generates a secondary magnetic field whose lines of force, at the conductor, are such that they oppose those of the primary magnetic field. The receiver coil, at some distance from the transmitter coil, is therefore energized by two fields: from the transmitter and from the induced currents in the ground.

(3) From Faraday's Law, the EMF induced in the receiver may be expressed as

$$EMF_R = M_{RT} \frac{dI_T}{dt} + M_{RC} \frac{dI_C}{dt} \quad (4-24)$$

where

$EMF_R$  = EMF induced in the receiver

$M_{RT}$  = mutual inductance between the receiver (R) and transmitter (T)

$M_{RC}$  = mutual inductance between the receiver (R) and conductor (C) in the ground, a complex number

$dI_C/dt$  or  $dI_T/dt$  = time derivative of the current induced in the conductor (C) or transmitter (T)

$I_T$  or  $I_C$  = current induced in the conductor (C) or transmitter (T)

(4) Note that the induced currents occur throughout the subsurface, and that the magnitude and distribution are functions of the transmitter frequency, power, and geometry and the distribution of all 'electrical properties' in the subsurface, i.e., everything (not just an isolated 'conductor'). The above discussion simplifies the problem by assuming the presence of only one conductor embedded in a much less conducting medium.

*b. Frequency domain EM method.* In the frequency domain method, the transmitter emits a sinusoidally varying current at a specific frequency. For example, at a frequency of 100 Hz the magnetic field amplitude at the receiver will be that shown in the top part of Figure 4-40. Because the mutual inductance between the transmitter and conductor is a complex quantity, the electromagnetic force induced in the conductor will be shifted in phase with respect to the primary field, similar to the illustration

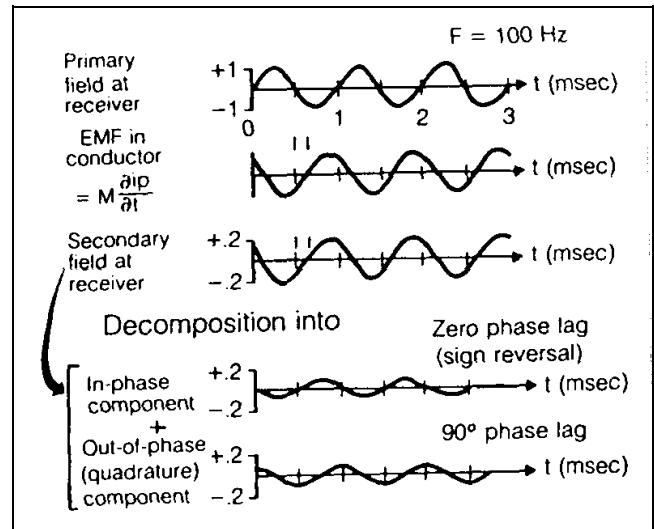

Figure 4-40. Generalized picture of the frequency domain EM method (Klein and Lajoie 1980; copyright permission granted by Northwest Mining Association and Klein)

in the lower part of Figure 4-40. At the receiver, the secondary field generated by the currents in the conductor will also be shifted in phase by the same amount. There are three methods of measuring and describing the secondary field.

(1) Amplitude and phase. The amplitude of the secondary field can be measured and is usually expressed as a percentage of the theoretical primary field at the receiver. Phase shift, the time delay in the received field by a fraction of the period, can also be measured and displayed.

(2) In phase and out-of-phase components. The second method of presentation is to electronically separate the received field into two components, as shown in the lower part of Figure 4-40.

(a) The first component is in phase with the transmitted field while the second component is exactly 90 deg out-of-phase with the transmitted field. The in-phase component is sometimes called the real component, and the out-of-phase component is sometimes called the "quadrature" or "imaginary" component.

(b) Both of the above measurements require some kind of phase link between transmitter and receiver to establish a time or phase reference. This is commonly done with a direct wire link, sometimes with a radio link,



or through the use of highly accurate, synchronized crystal clocks in both transmitter and receiver.

(3) Tilt angle systems. The simpler frequency domain EM systems are tilt angle systems which have no reference link between the transmitter and receiver coils. The receiver simply measures the total field irrespective of phase, and the receiver coil is tilted to find the direction of maximum or minimum magnetic field strength. As shown conceptually in Figure 4-39, at any point the secondary magnetic field may be in a direction different from the primary field. With tilt angle systems, therefore, the objective is to measure deviations from the normal in-field direction and to interpret these in terms of geological conductors.

(4) The response parameter of a conductor is defined as the product of conductivity-thickness ( $\sigma t$ ), permeability ( $\mu$ ), angular frequency ( $\omega = 2\pi f$ ), and the square of some mean dimension of the target ( $a^2$ ). The response parameter is a dimensionless quantity. In MKS units, a poor conductor will have a response parameter of less than about 1, whereas an excellent conductor will have a response value greater than 1,000. The relative amplitudes of in-phase and quadrature components as a function of response parameter are given in Figure 4-41 for the particular case of the sphere model in a uniform alternating magnetic field. For low values of the response parameter ( $< 1$ ), the sphere will generally produce a low-amplitude out-of-phase anomaly; at moderate values of the response parameter (10-100), the response will be a moderate-amplitude in-phase and out-of-phase anomaly, whereas for high values of the response parameter ( $>1,000$ ), the response will usually be in the in-phase component. Although Figure 4-41 shows the response

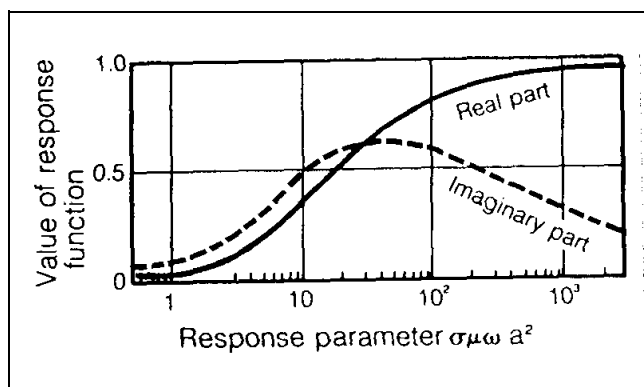

Figure 4-41. In-phase and out-of-phase response of a sphere in a uniform alternating magnetic field (Klein and Lajoie 1980; copyright permission granted by Northwest Mining Association and Klein)

only for the particular case of a sphere in a uniform field, the response functions for other models are similar.

(5) In frequency domain EM, depth and size of the conductor primarily affect the amplitude of the secondary field. The quality of the conductor (higher conductivity means higher quality) mainly affects the ratio of in-phase to out-of-phase amplitudes ( $A_R/A_I$ ), a good conductor having a higher ratio (left side of Figure 4-41) and a poorer conductor having a lower ratio (right side of Figure 4-41).

(6) Of the large number of electrical methods, many of them are in the frequency domain electromagnetic (FDEM) category and are not often used in geotechnical and environmental problems. Most used for these problems are the so-called terrain conductivity methods, VLF (very low frequency EM method), and a case of instruments called metal detectors.

*c. Interpretation procedures.*

(1) Interpretation of electromagnetic surveys follows basic steps. Most of the common EM systems have nomograms associated with them. Nomograms are diagrams on which the measured parameters, e.g., in-phase and out-of-phase components, are plotted for varying model conductivity and one or more geometrical factors, e.g., depth to top, thickness, etc. The model responses available for most electromagnetic methods are those of the long, thin dike (to model thin tabular bodies), a homogeneous earth, and a horizontal layer for simulating conductive overburden.

(2) The first step is to attempt to determine from the shape of the anomaly a simple model geometry which can be thought to approximate the cause of the anomaly. The second step is to measure characteristics of the anomaly such as in-phase and out-of-phase amplitudes, and to plot these at the scale of the appropriate nomograms. From the nomogram and the shape of the anomaly, estimates generally can be made for: quality of the conductor, depth to top of the conductor, conductor thickness, dip, strike, and strike length.

**4-8. Terrain Conductivity**

*a. Introduction.* Terrain conductivity EM systems are frequency domain electromagnetic instruments which use two loops or coils. To perform a survey, one person generally carries a small transmitter coil, while a second person carries a second coil which receives the primary and secondary magnetic fields. Such devices can allow a

rapid determination of the average conductivity of the ground because they do not require electrical contact with the ground as is required with DC resistivity techniques. The disadvantage is that unless several (usually three) intercoil spacings for at least two coil geometries are measured at each location, minimal vertical sounding information is obtained. If the geology to the depth being explored is fairly homogeneous or slowly varying, then the lack of information about vertical variations may not be a problem, and horizontal profiling with one coil orientation and spacing is often useful. This technique is usually calibrated with a limited number of DC resistivity soundings. Horizontal profiling with the terrain conductivity meter is then used to effectively extend the resistivity information away from the DC sounding locations.

(1) McNeill (1990) gives an excellent review and tutorial of electromagnetic methods and much of his discussion on the terrain conductivity meter is excerpted here (see also Butler (1986)). He lists three significant differences between terrain conductivity meters and the traditional HLEM (horizontal loop electromagnetic) method usually used in mining applications. Perhaps the most important is that the operating frequency is low enough at each of the intercoil spacings that the electrical skin depth in the ground is always significantly greater than the intercoil spacing. Under this condition (known as “operating at low induction numbers”) virtually all response from the ground is in the quadrature phase component of the received signal. With these constraints, the secondary magnetic field can be represented as

$$\frac{H_s}{H_p} = \frac{i\omega\mu_0\sigma s^2}{4} \quad (4-25)$$

where

$H_s$  = secondary magnetic field at the receiver coil

$H_p$  = primary magnetic field at the receiver coil

$\omega = 2\pi f$

$f$  = frequency in Hz

$\mu_0$  = permeability of free space

$\sigma$  = ground conductivity in S/m (mho/m)

$s$  = intercoil spacing in m

$i = (-1)^{1/2}$ , denoting that the secondary field is 90 deg out of phase with the primary field

(a) Thus, for low and moderate conductivities, the quadrature phase component is linearly proportional to ground conductivity, so the instruments read conductivity directly (McNeill 1980). Given  $H_s/H_p$ , the apparent conductivity indicated by the instrument is defined as

$$\sigma_a = 4 \frac{\left[ \frac{H_s}{H_p} \right]}{\mu_0 \omega s^2} \quad (4-26)$$

The low induction number condition also implies that the measured signals are of extremely low amplitude. Because of the low amplitude signals, terrain conductivity meters must have detection electronics which are an order of magnitude more sensitive than conventional HLEM systems.

(b) The second difference is that terrain conductivity instruments are designed so that the quadrature phase zero level stays constant with time, temperature, etc., to within about 1 millisiemen/meter (or mS/m). The stability of this zero level means that at moderate ground conductivity, these devices give an accurate measurement of bulk conductivity of the ground. These devices, like the conventional HLEM system, do not indicate conductivity accurately in high resistivity ground, because the zero error becomes significant at low values of conductivity.

(c) The third difference is that operation at low induction numbers means that changing the frequency proportionately changes the quadrature phase response. In principle and in general, either intercoil spacing or frequency can be varied to determine variation of conductivity with depth. However, in the EM-31, EM-34, and EM-38 systems, frequency is varied as the intercoil spacing is varied. Terrain conductivity meters are operated in both the horizontal and vertical dipole modes. These terms describe the orientation of the transmitter and receiver coils to each other and the ground, and each mode gives a significantly different response with depth as shown in Figure 4-42. Figure 4-43 shows the cumulative response curves for both vertical dipoles and horizontal dipoles. These curves show the relative contribution to the secondary magnetic field (and hence apparent conductivity) from all material below a given depth. As an example, this figure shows that for vertical dipoles, all material below a depth of two intercoil spacings yields a

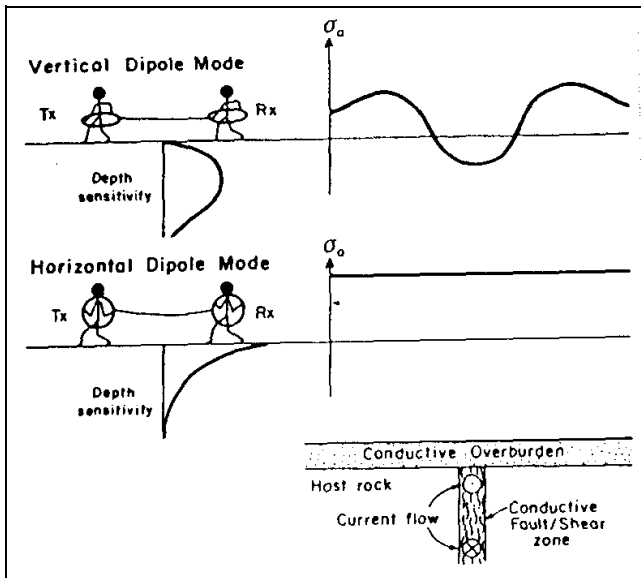

Figure 4-42. Terrain conductivity meter response over conductive dike (McNeill 1990; copyright permission granted by Society of Exploration Geophysicists)

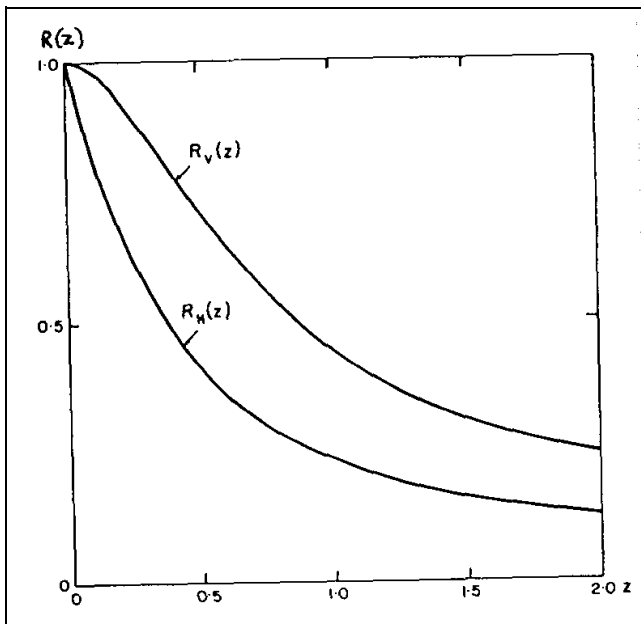

Figure 4-43. Cumulative response curves for both vertical coplanar and horizontal coplanar dipoles.  $z$  is actually depth/intercoil spacing (McNeill 1980; copyright permission granted by Geonics Limited)

relative contribution of approximately 0.25 (25 percent) to the response, i.e. the conductivity measurement. Thus, effective exploration depth in a layered earth geometry is approximately 0.25 to 0.75 times the intercoil spacing for

the horizontal dipole mode and 0.5 to 1.5 for the vertical dipole mode. The commonly used systems use intercoil spacings of 1 m, 3.66 m, 10 m, 20 m, and 40 m.

(d) Terrain conductivity meters have shallower exploration depths than conventional HLEM, because maximum intercoil spacing is 40 m for the commonly used instruments. However, terrain conductivity meters are being widely used in geotechnical and environmental investigations. Of particular interest is the fact that when used in the vertical dipole mode the instruments are more sensitive to the presence of relatively conductive, steeply dipping structures, whereas in the horizontal dipole mode the instruments are quite insensitive to this type of structure and can give accurate measurement of ground conductivity in close proximity to them.

(2) Phase and other information is obtained in real time by linking the transmitter and receiver with a connecting cable. The intercoil spacing is determined by measuring the primary magnetic field with the receiver coil and adjusting the intercoil spacing so that it is the correct value for the appropriate distance. In the vertical dipole mode, the instruments are relatively sensitive to intercoil alignment, but much less so in the horizontal dipole mode. Terrain conductivity is displayed on the instrument in mS/m. (A conductivity of 1 mS/m corresponds to a resistivity of 1 k $\Omega$ m or 1,000  $\Omega$ m.)

*b. Interpretation.* Because terrain conductivity meters read directly in apparent conductivity and most surveys using the instrument are done in the profile mode, interpretation is usually qualitative and of the “anomaly finding” nature. That is, the area of interest is surveyed with a series of profiles with a station spacing dictated by the required resolution and time/economics consideration. Typical station spacings are one-third to one-half the intercoil spacing. Any anomalous areas are investigated further with one or more of the following: other types of EM, resistivity sounding, other geophysical techniques, and drilling. Limited information about the variation of conductivity with depth can be obtained by measuring two or more coil orientations and/or intercoil separations and using one of several commercially available computer programs. The maximum number of geoelectric parameters, such as layer thicknesses and resistivities, which can be determined, is less than the number of independent observations. The most common instrument uses three standard intercoil distances (10, 20, and 40 m) and two intercoil orientations, which results in a maximum of six observations. Without other constraints, a two-layer model is the optimum.

(1) Example 1 - mapping industrial groundwater contamination.

(a) Non-organic (ionic) groundwater contamination usually results in an increase in the conductivity of the groundwater. For example, in a sandy soil the addition of 25 ppm of ionic material to groundwater increases ground conductivity by approximately 1 mS/m. The problem is to detect and map the extent of the contamination in the presence of conductivity variations caused by other parameters such as changing lithology. Organic contaminants are generally insulators and so tend to reduce the ground conductivity, although with much less effect than an equivalent percentage of ionic contaminant. Fortunately, in many cases where toxic organic substances are present, there are ionic materials as well, and the plume is

mapped on the theory that the spatial distribution of both organic and ionic substances is essentially the same, a fact which must be verified by subsequent sampling from monitoring wells installed on the basis of the conductivity map.

(b) McNeill (1990) summarizes a case history by Ladwig (1982) which uses a terrain conductivity meter to map the extent of acid mine drainage in a rehabilitated surface coal mine in Appalachia. Measurements were taken with an EM ground conductivity meter in the horizontal dipole mode at both 10- and 20-m intercoil spacings (10-m data are shown in Figure 4-44). Ten survey lines, at a spacing of 25 m, resulted in 200 data points for each spacing; the survey took 2 days to complete. In general, conductivity values of the order of 6-10 mS/m

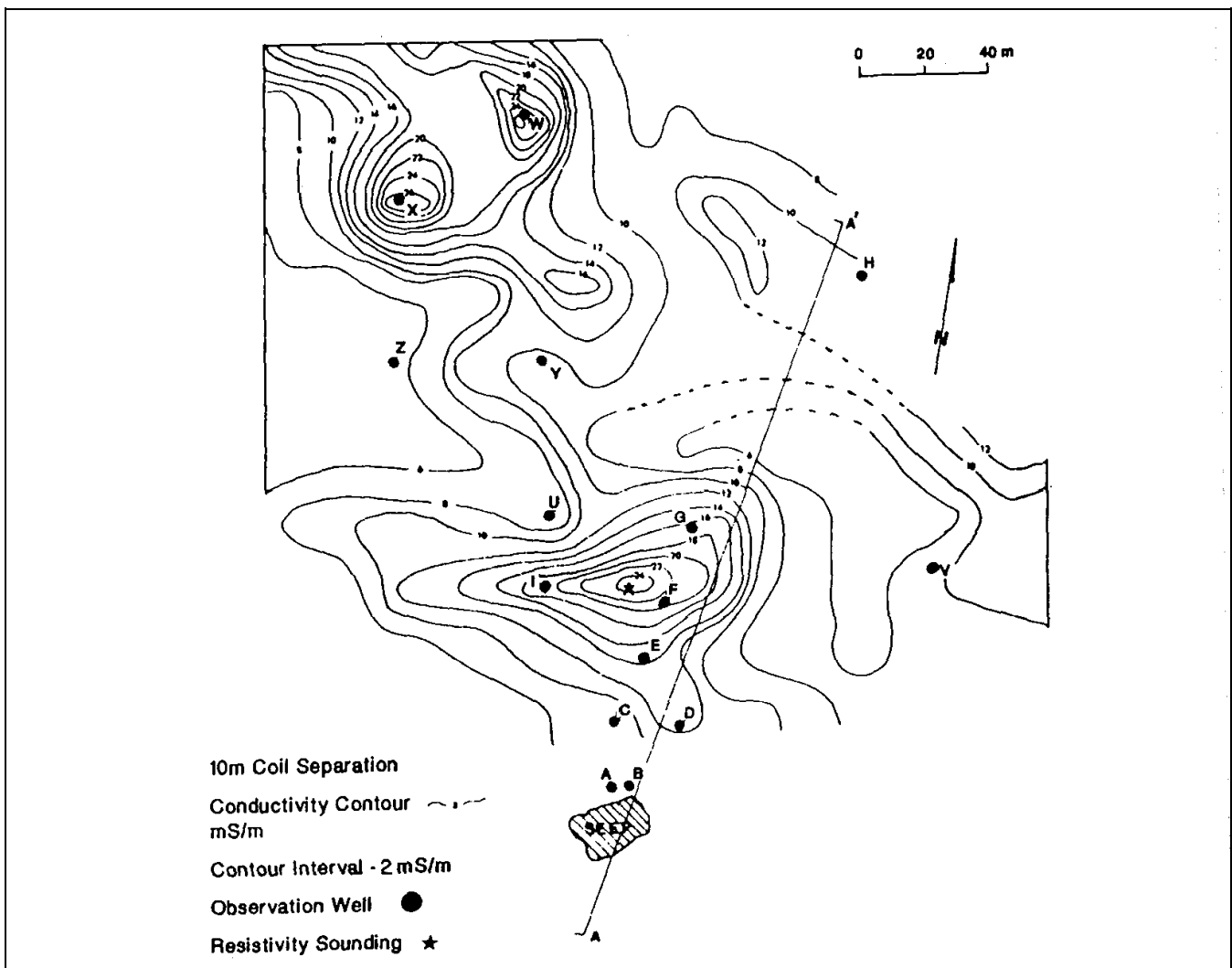

Figure 4-44. Contours of apparent resistivity for an acid mine dump site in Appalachia from terrain conductivity meter (Ladwig (1982) in McNeill (1990); copyright permission granted by Society of Exploration Geophysicists)

are consistent with a porous granular material reasonably well-drained or containing nonmineralized groundwater. Superimposed on this background are two steep peaks (one complex) where conductivities rise above 20 mS/m.

Wells F, G, and X were the only wells to encounter buried refuse (well W was not completed), and all three are at or near the center of the high conductivity zones. The water surface at well F is about 3 m below the surface, and at well X is 16.2 m below the surface. In fact, the only region where the water surface is within 10 m of the surface is at the southern end of the area; the small lobe near well D corresponds to the direction of groundwater flow to the seep (as the result of placement of a permeability barrier just to the west of the well). It thus appears that in the area of wells X and W, where depth to water surface is large, the shape and values of apparent conductivity highs are due to vertically draining areas of acidity. Further to the south the conductivity high is probably reflecting both increased acidity and proximity of the water surface.

(2) Examples 2 and 3 - mapping soil and groundwater salinity.

(a) EM techniques are well suited for mapping soil salinity to depths useful for the agriculturalist (the root zone, approximately 1 m) and many salinity surveys have been carried out with EM ground conductivity meters (McNeill 1990). In arid areas where the water surface is near the surface (within a meter or so), rapid transport of water to the surface as a result of capillary action and evaporation takes place, with the consequence that dissolved salts are left behind to hinder plant growth (McNeill 1986).

(b) An EM terrain conductivity meter with short intercoil spacing (a few meters or less) is necessary to measure shallow salinity. Fortunately the values of conductivity which result from agriculturally damaging salinity levels are relatively high and interfering effects from varying soil structure, clay content, etc. can usually be ignored. Equally important, because salt is hygroscopic, those areas which are highly salinized seem to retain enough soil moisture to keep the conductivity at measurable levels even when the soil itself is relatively dry.

(c) McNeill (1990) summarizes the results of a high-resolution survey of soil salinity carried out by Wood (1987) over dry farm land in Alberta, Canada (Figure 4-45). For this survey an EM terrain conductivity meter with an intercoil spacing of 3.7 m was mounted in the vertical dipole mode on a trailer which was in turn

towed behind a small four-wheeled, all-terrain vehicle. The surveyed area is 1,600 m long by 750 m wide. The 16 survey lines were spaced 50 m apart resulting in a total survey of 25 line km, which was surveyed in about 7 hr at an average speed of 3.5 km/hour. Data were collected automatically every 5.5 m by triggering a digital data logger from a magnet mounted on one of the trailer wheels.

(d) Survey data are contoured directly in apparent conductivity at a contour interval of 20 mS/m. The complexity and serious extent of the salinity is quite obvious. The apparent conductivity ranges from a low of 58 mS/m, typical of unsalinized Prairie soils, up to 300 mS/m, a value indicating extreme salinity. Approximately 25 percent of the total area is over 160 mS/m, a value indicating a high level of salinity. The survey revealed and mapped extensive subsurface salinity, not apparent by surface expression, and identified the areas most immediately threatened.

(e) An example of a deeper penetrating survey to measure groundwater salinity was conducted by Barker (1990). The survey illustrates the cost-effective use of electromagnetic techniques in the delineation of the lateral extent of areas of coastal saltwater intrusion near Dungeness, England. As with most EM profiling surveys, a number of resistivity soundings were first made at the sites of several drill holes to help design the EM survey. In Figure 4-46, a typical sounding and interpretation shows a three-layer case in which the low resistivity third layer appears to correlate with the conductivity of water samples from the drill holes and the formation clay/sand lithology. To achieve adequate depth of investigation so that changes in water conductivity within the sands would be clearly identified, large coil spacings of 20 and 40 m were employed. The area is easily accessible and measurements can be made rapidly but to reduce errors of coil alignment over some undulating gravel ridges, a vertical coil configuration was employed. This configuration is also preferred as the assumption of low induction numbers for horizontal coils breaks down quickly in areas of high conductivity. The extent of saline groundwater is best seen on Figure 4-47, which shows the contoured ground conductivity in mS/m for the 40-m coil spacing. This map is smoother and less affected by near-surface features than measurements made with the 20-m coil spacing, and shows that the saline intrusion generally occurs along a coastal strip about 0.5 km wide. However, flooding of inland gravel pits by the sea during storms has allowed marine incursion in the west, leaving an isolated body of fresh water below Dungeness.

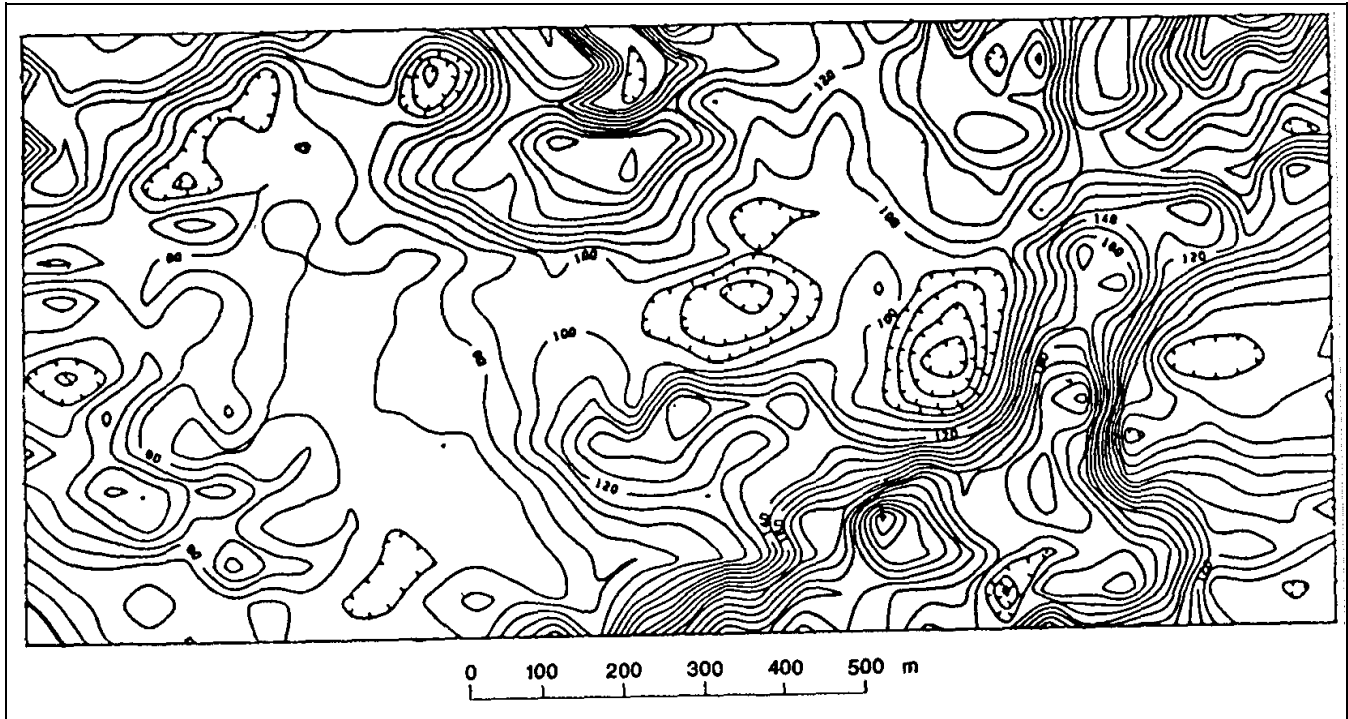

Figure 4-45. Contours of apparent conductivity measured with ground conductivity meter over dry farm land, Alberta, Canada (Wood (1987) in McNeill (1990); copyright permission granted by Society of Exploration Geophysicists)

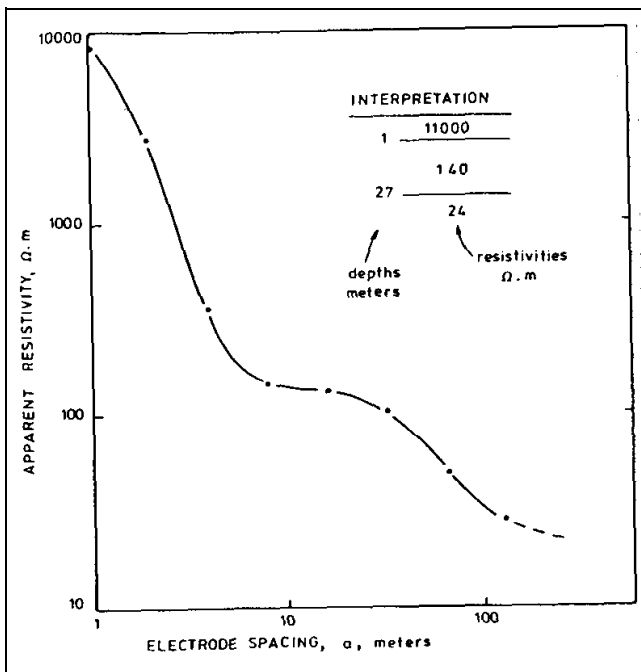

Figure 4-46. Typical resistivity sounding and interpretation, Dungeness, England (Barker 1990; copyright permission granted by Society of Exploration Geophysicists)

(3) Example 4 - subsurface structure. Dodds and Ivic (1990) describe a terrain conductivity meter survey to investigate the depth to basement in southeast Australia. During the first part of the survey, time domain EM and resistivity soundings were used to detect a basement high which impedes the flow of saline groundwater. In the second part of the survey, a terrain conductivity meter was used to map the extent of the basement high "as far and as economically as possible." The largest coil separation available with the instrument, 40 m, was used to get the deepest penetration with horizontal coil orientation. A very limited amount of surveying, using short traverses, successfully mapped out a high-resistivity feature (Figure 4-48). This zone is confirmed by the plotted drilling results.

#### 4-9. Metal Detector Surveys

The term "metal detector" (MD) generally refers to some type of electromagnetic induction instrument, although traditional magnetometers are often used to find buried metal. The disadvantage of magnetometers is that they can be used only for locating ferrous metals. MD instruments in geotechnical and hazardous-waste site investigations have several uses:

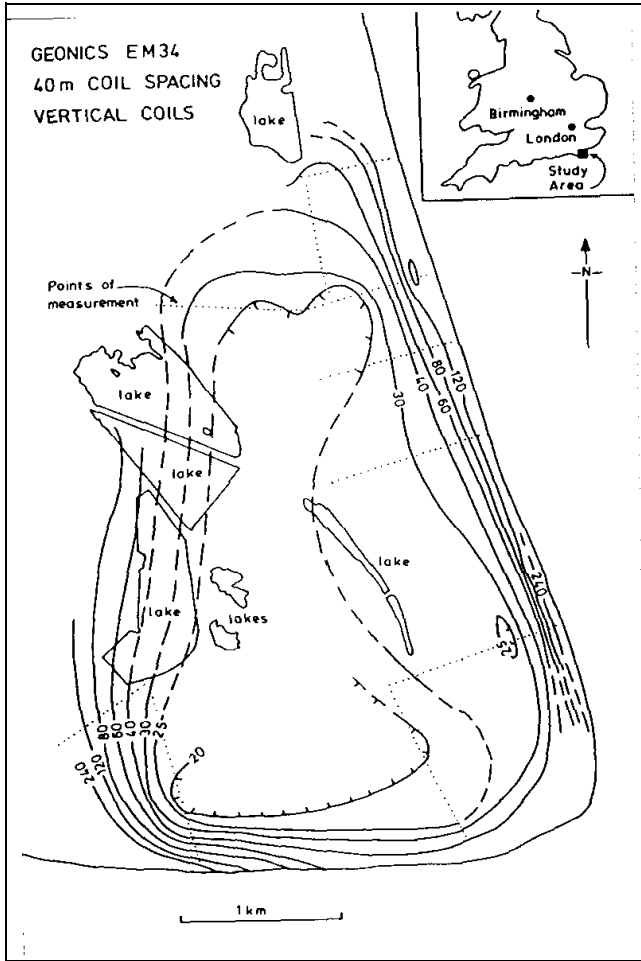

Figure 4-47. Contours of ground conductivity in mS/m, Dungeness, England (Barker 1990; copyright permission granted by Society of Exploration Geophysicists)

Location of shallow metal drums, canisters, cables, and pipes.

Progress assessment during metal object removal and location of additional objects.

Avoidance of old buried metal objects during new construction, remediation, or well placement.

a. MD use.

(1) In the smaller terrain conductivity meters, the transmitter and receiver coils are rigidly connected, allowing the in-phase response to be measured in addition to the quadrature response (McNeill 1990). Some basic equations are given in Section 4-7, "Frequency-Domain EM Methods." This feature allows systems such as the

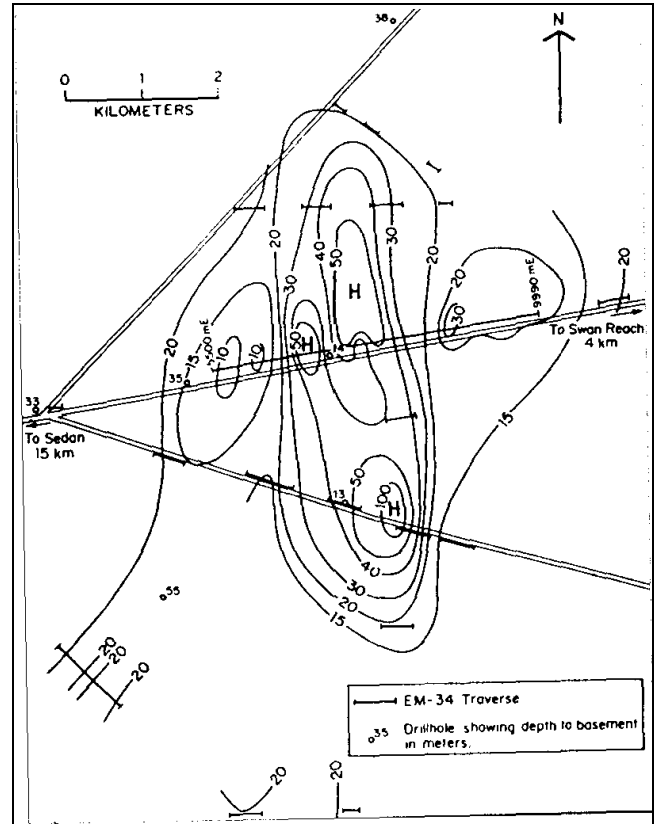

Figure 4-48. Apparent resistivity contours in  $\Omega m$  from a terrain conductivity meter in southern Australia (Dodds and Ivic 1990; copyright permission granted by Society of Exploration Geophysicists)

EM-31 and EM-38 to function as MD's. Several coil arrangements are favored by different commercial manufacturers. The smallest units have coil diameters of as little as 0.2 m and use a vertical-axis, concentric coil arrangement. These instruments are the coin and jewelry "treasure finders" used on every tourist beach in the world; they have very limited depth of investigation for geotechnical targets (Figure 4-49 from Benson, Glaccum, and Noel (1983)). One of the newest and most sophisticated MD uses three vertical-axis, 1-m<sup>2</sup> coils: one transmitter coil, one main receiving coil coincident with the transmitter, and one "focussing" coil 0.4 m above the main coil. This instrument continuously records the data and has sophisticated computer software which can yield depth of the object and other properties. In a third, and very common, coil arrangement, the transmitter loop is horizontal and the receiver loop is perpendicular in the vertical plane (Figure 4-50 from Benson, Glaccum, and Noel (1983)).

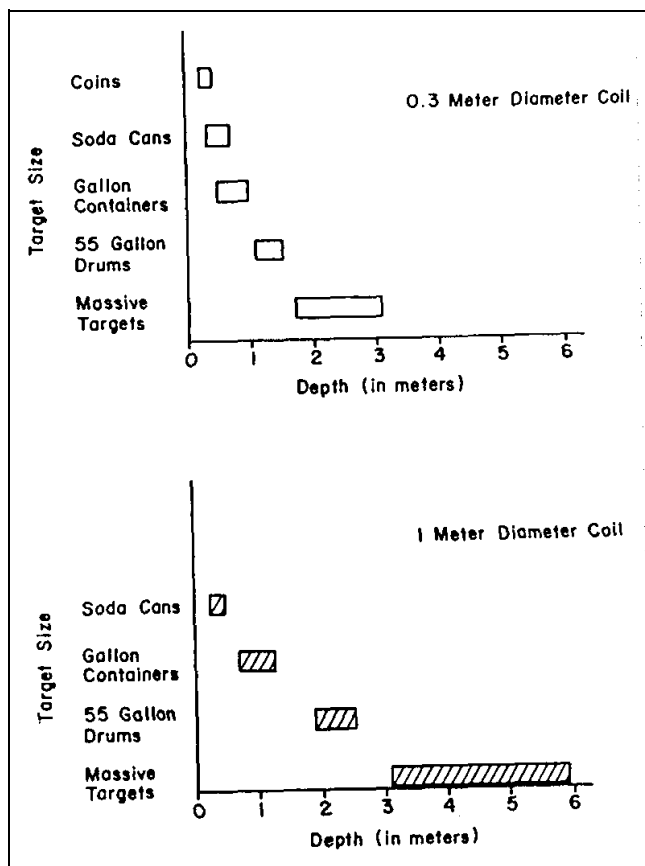

Figure 4-49. Approximate metal detector (MD) detection depths for various targets with two coil sizes (Benson, Glaccum, and Noel 1983)

(2) Another method of classifying MD instruments is by typical application: “hobby” and “treasure finding” equipment, sensitive to very shallow and smaller surface area targets; utility-location and military instruments, sensitive to deeper and larger objects, but usually without data recording and post-processing provisions; and, specialized instruments with large coils, possibly vehicle-mounted with continuous data recording and postprocessing.

(a) The two most important target properties which increase the secondary field (and thus optimize detection) are increased surface area within the target mass and decreased depth of burial. Overall target mass is relatively unimportant; response is proportional to surface area cubed (Hempen and Hatheway 1992). Signal response is proportional to depth; so, depths of detection rarely exceed 10 to 15 m even for sizable conductors. Often of great importance, and unlike magnetometers, MD produce a response from nonferrous objects such as aluminum, copper, brass, or conductive foil.

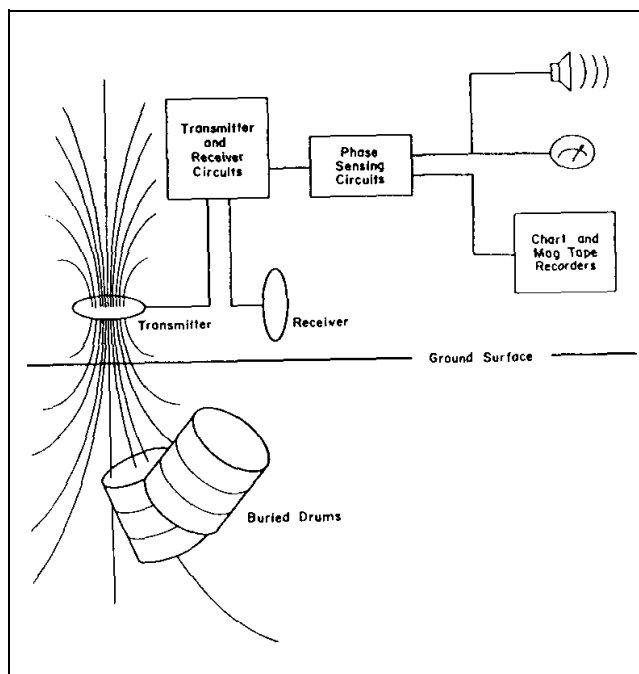

Figure 4-50. Block diagram of one MD coil arrangement and associated electronics (Benson, Glaccum, and Noel 1983)

(b) The main advantages of MD instruments are: both ferrous and nonferrous metals may be detected; the surface area of the target is more important than its mass; and surveys are rapid and detailed and inexpensive. The main disadvantages are: depth of investigation is very limited with most instruments; and metallic litter and urban noise can severely disrupt MD at some sites.

*b. MD example.* Figure 4-51 shows a test survey made with one of the new generation of sophisticated MD over a variety of buried metal objects and compared with a magnetic gradiometer (Geonics 1993). Both instruments appear to have “detected” all of the buried objects but the quality of spatial resolution is quite different. Spatial resolution is judged by how tightly the response of an instrument fits the target. The magnetometer resolves the single barrels very well. Spurious dipolar-lows become evident for the barrel clusters, and complex responses are recorded around the pipes and sheets. The MD responses fit all the targets very well, regardless of shape, orientation, or depth. This particular MD also shows the value of a second receiver coil to help distinguish between near surface and deeper targets.



# Columbia Test-Site EM61 vs. Gradiometer

**EM61 Metal Detector**  
 Good depth of exploration  
 Excellent spatial resolution  
 Excellent Interpretability

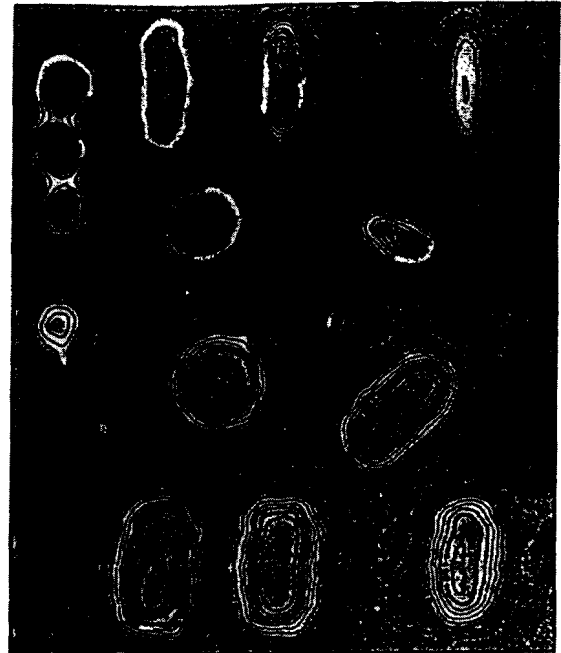

EM61 Amplitude (millivolts)

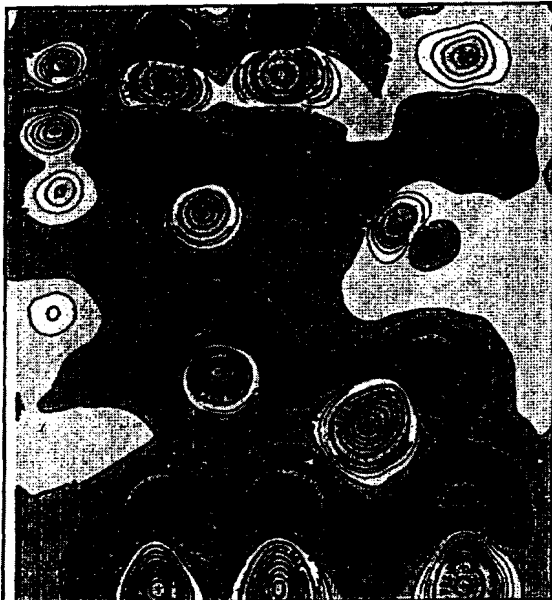

Gradiometer (Magnetics)

**Gradiometer**  
 Excellent depth of exploration  
 Poor spatial resolution  
 Poor interpretability

**LEGEND:**

- Vertical barrel, 0.6m by 0.9m high
- Pipe, 0.1m by 8m
- ▭ Sheet metal, 1m by 8m

Plotted next to the hazards are their burial depths in meters.

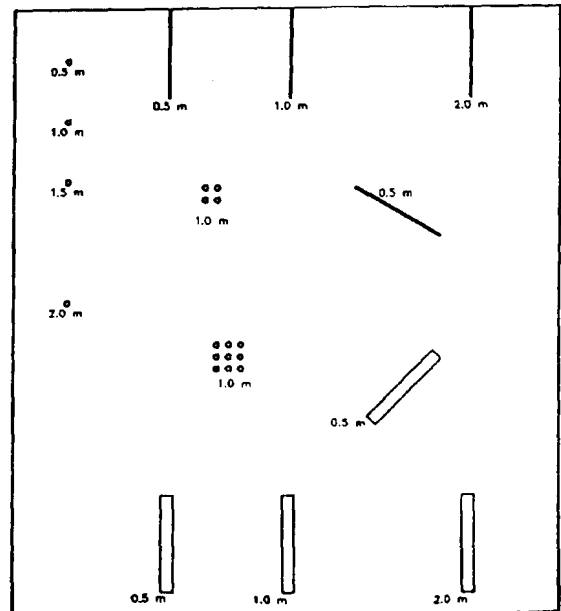

Columbia Test-Site Map

Figure 4-51. Test survey using a metal detector and a magnetic gradiometer (Geonics (1993); copyright permission granted by Geonics Limited)

#### 4-10. Ground-Penetrating Radar

*a. Introduction.* Ground-penetrating radar (GPR) uses a high-frequency (80 to 1,000 MHz) EM pulse transmitted from a radar antenna to probe the earth. The transmitted radar pulses are reflected from various interfaces within the ground and this return is detected by the radar receiver. Reflecting interfaces may be soil horizons, the groundwater surface, soil/rock interfaces, man-made objects, or any other interface possessing a contrast in dielectric properties. The dielectric properties of materials correlate with many of the mechanical and geologic parameters of materials.

(1) The radar signal is imparted to the ground by an antenna that is in close proximity to the ground. The reflected signals can be detected by the transmitting antenna or by a second, separate receiving antenna. The received signals are processed and displayed on a graphic recorder. As the antenna (or antenna pair) is moved along the surface, the graphic recorder displays results in a cross-section record or radar image of the earth. As GPR has short wavelengths in most earth materials, resolution of interfaces and discrete objects is very good. However, the attenuation of the signals in earth materials is high and depths of penetration seldom exceed 10 m. Water and clay soils increase the attenuation, decreasing penetration.

(2) The objective of GPR surveys is to map near-surface interfaces. For many surveys, the location of objects such as tanks or pipes in the subsurface is the objective. Dielectric properties of materials are not measured directly. The method is most useful for detecting changes in the geometry of subsurface interfaces.

(3) Geologic problems conducive to solution by GPR methods are numerous and include the following: bedrock configuration, location of pipes and tanks, location of the groundwater surface, borrow investigations, and others. Geologic and geophysical objectives determine the specific field parameters and techniques. Delineation of the objectives and the envelope of acceptable parameters are specified in advance. However, as the results cannot be foreseen from the office, considerable latitude is given to the field geophysicist to incorporate changes in methods and techniques.

(4) The following questions are important considerations in advance of a GPR survey.

(a) What is the target depth? Though target detection has been reported under unusually favorable

circumstances at depths of 100 m or more, a careful feasibility evaluation is necessary if the investigation depths need to exceed 10 m.

(b) What is the target geometry? Size, orientation, and composition are important.

(c) What are the electrical properties of the target? As with all geophysical methods, a contrast in physical properties must be present. Dielectric constant and electrical conductivity are the important parameters. Conductivity is most likely to be known or easily estimated.

(d) What are the electrical properties of the host material? Both the electrical properties and homogeneity of the host must be evaluated. Attenuation of the signal is dependent on the electrical properties and on the number of minor interfaces which will scatter the signal.

(e) Are there any possible interfering effects? Radio frequency transmitters, extensive metal structures (including cars) and power poles are probable interfering effects for GPR.

(f) Electromagnetic wave propagation. The physics of electromagnetic wave propagation are beyond the scope of this manual. However, there are two physical parameters of materials which are important in wave propagation at GPR frequencies. One property is conductivity ( $\sigma$ ), the inverse of electrical resistivity ( $\rho$ ). The relationships of earth material properties to conductivity, measured in mS/m (1/1,000  $\Omega$ m), are given in Table 4-1 on resistivity.

(g) The other physical property of importance at GPR frequencies is the dielectric constant ( $\epsilon$ ), which is dimensionless. This property is related to how a material reacts to a steady-state electric field; that is, conditions where a potential difference exists but no charge is flowing. Such a condition exists between the plates of a charged capacitor. A vacuum has the lowest  $\epsilon$  and the performance of other materials is related to that of a vacuum. Materials made up of polar molecules, such as water, have a high  $\epsilon$ . Physically, a great deal of the energy in an EM field is consumed in interaction with the molecules of water or other polarizable materials. Thus waves propagating through such a material both go slower and are subject to more attenuation. To complicate matters, water, of course, plays a large role in determining the conductivity (resistivity) of earth materials.

*b. Earth material properties.* The roles of two earth materials, which cause important variations in the EM

response in a GPR survey, need to be appreciated. The ubiquitous component of earth materials is water; the other material is clay. At GPR frequencies the polar nature of the water molecule causes it to contribute disproportionately to the displacement currents which dominate the current flow at GPR frequencies. Thus, if significant amounts of water are present, the  $\epsilon$  will be high and the velocity of propagation of the electromagnetic wave will be lowered. Clay materials with their trapped ions behave similarly. Additionally, many clay minerals also retain water.

(1) The physical parameters in Table 4-3 are typical for the characterization of earth materials. The range for each parameter is large; thus the application of these parameters for field use is not elementary.

Simplified equations for attenuation and velocity (at low loss) are:

$$V = (3 \times 10^8) / \epsilon^{1/2} \quad (4-27)$$

$$a = 1.69 \sigma / \epsilon^{1/2} \quad (4-28)$$

where

$V$  = velocity in m/s

$\epsilon$  = dielectric constant (dimensionless)

$a$  = attenuation in decibels/m (db/m)

$\sigma$  = electrical conductivity in mS/m

A common evaluation parameter is dynamic range or performance figure for the specific GPR system. The performance figure represents the total attenuation loss during the two-way transit of the EM wave that allows reception; greater losses will not be recorded. As sample calculations, consider a conductive material ( $\sigma = 100$  mS/m) with some water content ( $\epsilon=20$ ). The above equations indicate a velocity of 0.07 m per nanosecond (m/ns) and an attenuation of 38 db/m. A GPR system with 100 db of dynamic range used for this material will cause the signal to become undetectable in 2.6 m of travel. The transit time for 2.6 m of travel would be 37 to 38 ns. This case might correspond geologically to a clay material with some water saturation. Alternatively, consider a dry material ( $\epsilon=5$ ) with low conductivity ( $\sigma = 5$  mS/m). The calculated velocity is 0.13 m/ns and the attenuation is 3.8 db/m, corresponding to a distance of 26-27 m for 100 db of attenuation and a travel time of 200 ns or more. This example might correspond to dry sedimentary rocks.

(2) These large variations in velocity and especially attenuation are the cause of success (target detection) and failure (insufficient penetration) for surveys in apparently similar geologic settings. As exhaustive catalogs of the properties of specific earth materials are not readily available, most GPR work is based on trial and error and empirical findings.

*c. Modes of operation.*

(1) The useful item of interest recorded by the GPR receiver is the train of reflected pulses. The seismic

**Table 4-3**  
**Electromagnetic Properties of Earth Materials**

Material	$\epsilon$	Conductivity (mS/m)	Velocity (m/ns)	Attenuation (db/m)
Air	1	0	.3	0
Distilled Water	80	.01	.033	.002
Fresh Water	80	.5	.033	.1
Sea Water	80	3,000	.01	1,000
Dry Sand	3-5	.01	.15	.01
Wet Sand	20-30	.1-1	.06	.03-.3
Limestone	4-8	.5-2	.12	.4-1
Shales	5-15	1-100	.09	1-100
Silts	5-30	1-100	.07	1-100
Clays	5-40	2-1,000	.06	1-300
Granite	4-6	.01-1	.13	.01-1
Dry Salt	5-6	.01-1	.13	.01-1
Ice	3-4	.01	.16	.01
Metals		$\infty$		$\infty$

reflection analogy is appropriate. The two reflection methods used in seismic reflection (common offset and common midpoint) are also used in GPR. Figure 4-52 illustrates these two modes. A transillumination mode is also illustrated in the figure which is useful in certain types of nondestructive testing. The typical mode of operation is the common-offset mode where the receiver and transmitter are maintained at a fixed distance and moved along a line to produce a profile. Figure 4-53 illustrates the procedure. Note that as in seismic reflection, the energy does not necessarily propagate only downwards and a reflection will be received from objects off to the side. An added complication with GPR is the fact that some of the energy is radiated into the air and, if reflected off nearby objects like buildings or support vehicles, will appear on the record as arrivals.

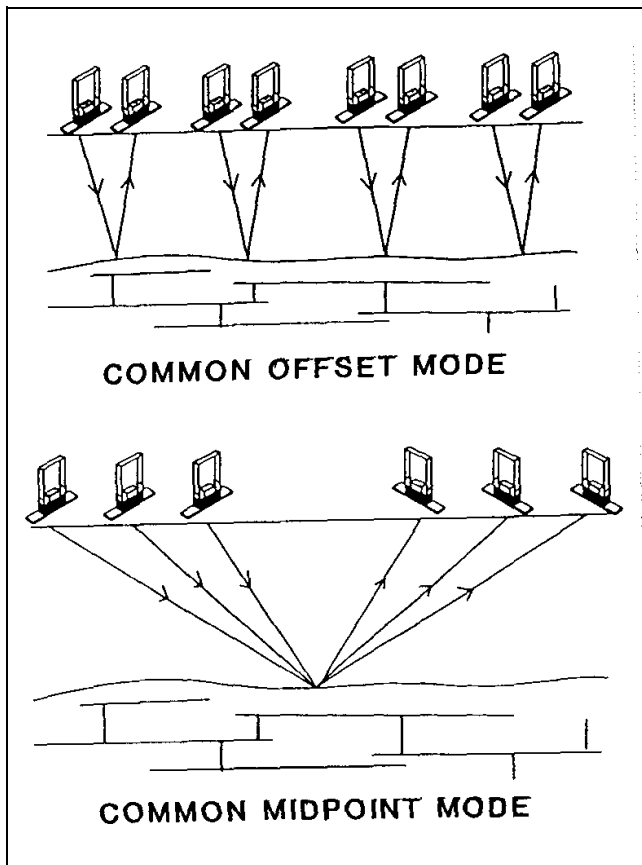

Figure 4-52. Common offset and common midpoint acquisition modes (Annan (1992))

(2) GPR records can be recorded digitally and reproduced as wiggle trace or variable area record sections. Figure 4-54 illustrates the presentation used when a graphic recorder is used to record analog data. Both

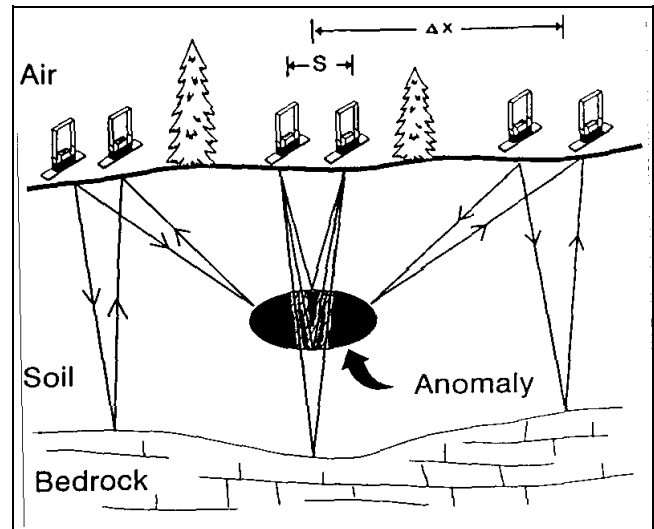

Figure 4-53. Schematic illustration of common-offset single-fold profiling

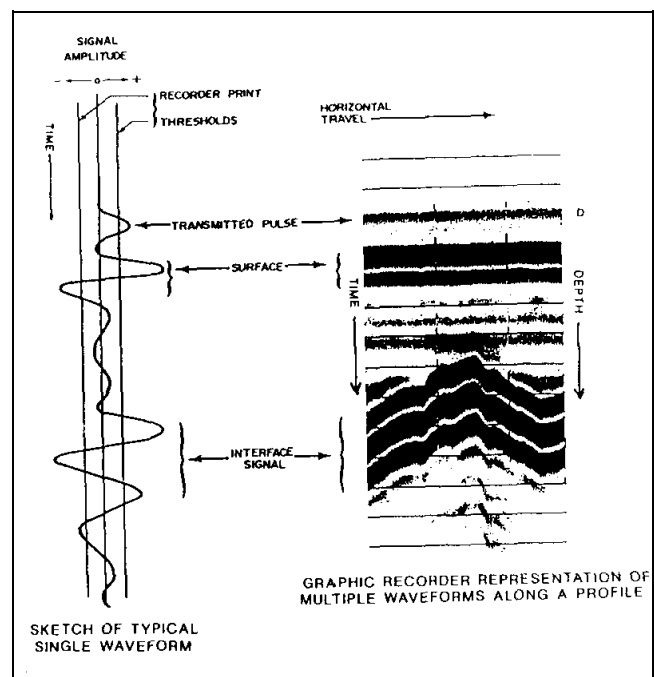

Figure 4-54. GPR received signal and graphic profile display (Benson, Glaccum, and Noel 1983)

negative and positive excursions in excess of the “threshold” appear as blackened portions of the record. This presentation is adequate for most tasks where target detection is the object and post-survey processing is not anticipated. Wide variations in the appearance of the record are possible, depending on the gain settings used.

*d. Field work.*

(1) A GPR crew consists nominally of two persons. One crew person moves the antenna or antenna pair along the profiles and the other operates the recorder and annotates the record so that the antenna position or midpoint can be recovered.

(2) The site-to-site variation in velocity, attenuation, and surface conditions is so large, that seldom can the results be predicted before field work begins. Additionally, the instrument operation is a matter of empirical trial and error in manipulating the appearance of the record. Thus, the following steps are recommended for most field work:

(a) Unpack and set up the instrument and verify internal operation.

(b) Verify external operation (one method is to point the antenna at a car or wall and slowly walk towards it. The reflection pattern should be evident on the record).

(c) Calibrate the internal timing by use of a calibrator.

(d) Calibrate the performance by surveying over a known target at a depth and configuration similar to the objective of the survey (considerable adjustment of the parameters may be necessary to enhance the appearance of the known target on the record).

(e) Begin surveying the area of unknown targets with careful attention to surface conditions, position recovery, and changes in record character.

Often a line will be done twice to be sure that all the features on the record are caused by the subsurface.

*e. Interpretation methods.* Because of the strong analogy between seismic reflection and GPR, the application of seismic processing methods to GPR data is a fertile field of current research. Such investigations are beyond the scope of this manual. The focus herein is on the most frequent type of GPR survey, location of specific targets.

(1) GPR surveys will not achieve the desired results without careful evaluation of site conditions for both geologic or stratigraphic tasks and target-specific interests. If the objectives of a survey are poorly drawn, often the results of the GPR survey will be excellent records which do not have any straightforward interpretation. It is

possible to tune a GPR system such that exceptional subsurface detail is visible on the record. The geologic evaluation problem is that, except in special circumstances (like the foreset beds inside of sand dunes), there is no ready interpretation. The record reveals very detailed stratigraphy, but there is no way to verify which piece of the record corresponds to which thin interbedding of alluvium or small moisture variation. GPR surveys are much more successful when a calibration target is available. GPR can be useful in stratigraphic studies; however, a calibrated response (determined perhaps from backhoe trenching) is required for geologic work.

(2) Figure 4-55 indicates that localized objects will produce a hyperbola on the record. The hyperbolic shape is due to reflection returns of the EM pulse before and after the antenna system is vertically above the target. The shortest two-way travel distance is when the antenna (or center of the antennae pair) is on the ground surface directly above the object. All other arrivals are at greater distances along a different hypotenuse with each varying horizontal antenna location.

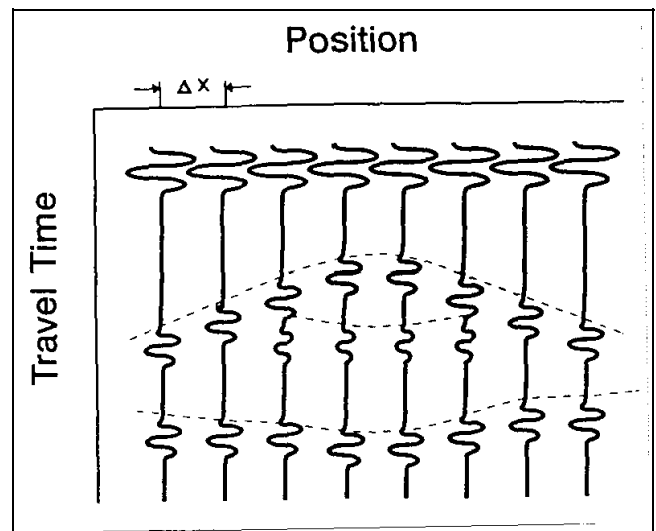

**Figure 4-55. Format of a GPR reflection section with radar events shown for features depicted in Figure 4-53**

(3) Figure 4-56 is the schematic of a set of targets surveyed by GPR. The record section of Figure 4-57 indicates the excellent detection of the targets.

*f. GPR case histories.* GPR has been widely used and reports on its effectiveness are available both in government and professional documents. Some useful references are:

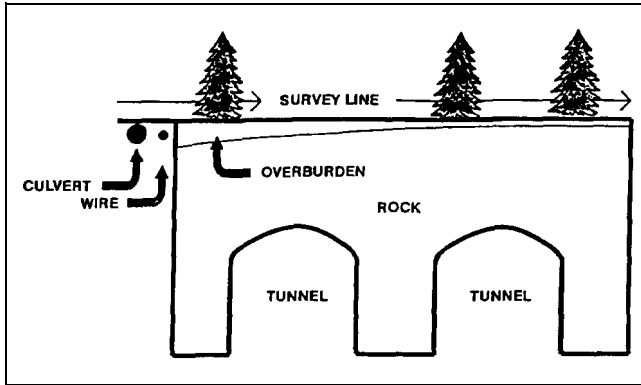

Figure 4-56. Schematic of a set of targets surveyed by GPR

- (1) Butler (1992), which is the proceedings of a GPR workshop and includes a tutorial and a collection of case histories.
- (2) Butler, Simms, and Cook (1994), which provides an archaeological site evaluation.
- (3) Sharp, Yule, and Butler (1990), which reports the GPR assessment of an HTRW site.

#### 4-11. Very Low-Frequency EM Procedures

##### a. General methodology.

(1) The VLF (very low-frequency) method uses powerful remote radio transmitters set up in different parts of the world for military communications (Klein and Lajoie 1980). In radio communications terminology, VLF means very low-frequency, about 15 to 25 kHz. Relative to frequencies generally used in geophysical exploration, these are actually very high frequencies. The radiated field from a remote VLF transmitter, propagating over a uniform or horizontally layered earth and measured on the earth's surface, consists of a vertical electric field component and a horizontal magnetic field component each perpendicular to the direction of propagation.

(2) These radio transmitters are very powerful and induce electric currents in conductive bodies thousands of kilometers away. Under normal conditions, the fields produced are relatively uniform in the far field at a large distance (hundreds of kilometers) from the transmitters. The induced currents produce secondary magnetic fields which can be detected at the surface through deviation of the normal radiated field.

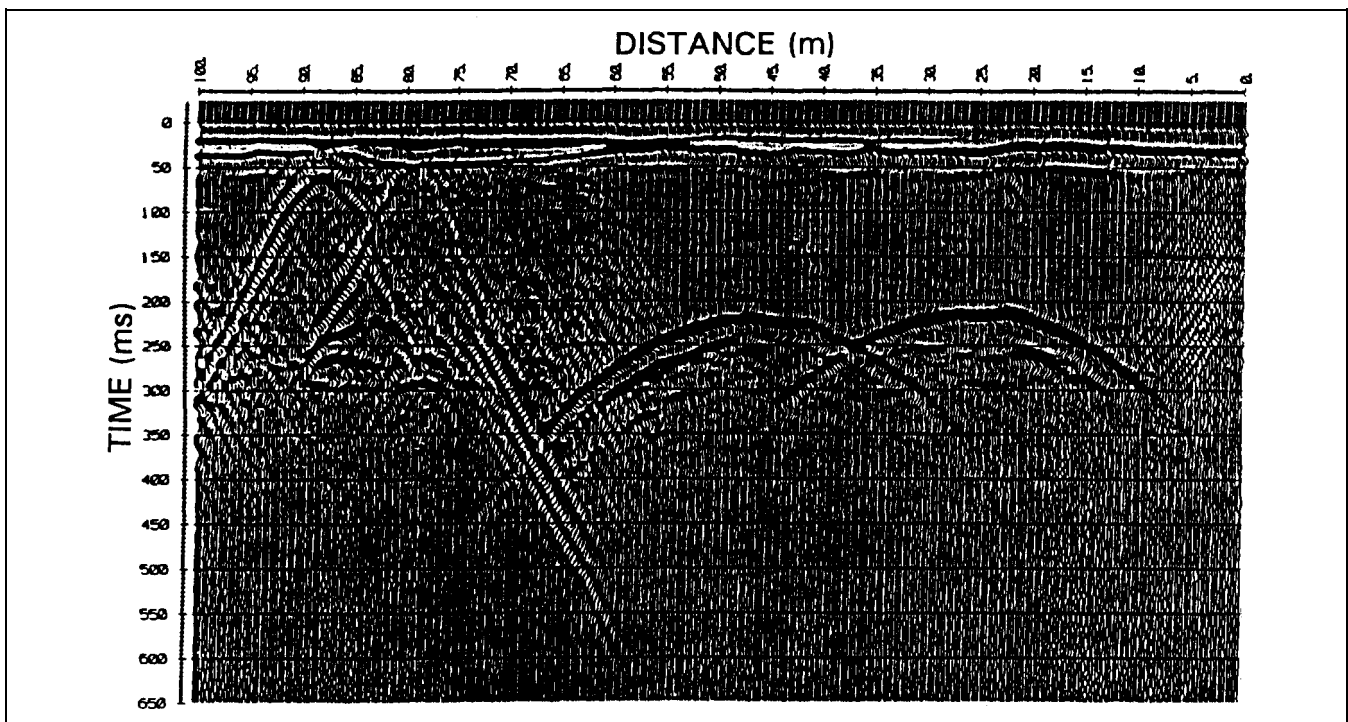

Figure 4-57. Actual GPR record over a culvert, pipe, and two tunnels showing the hyperbolic shape of the reflected/diffracted energy (Annan (1992))

(3) The VLF method uses relatively simple instruments and can be a useful reconnaissance tool. Potential targets include tabular conductors in a resistive host rock like faults in limestone or igneous terrain. The depth of exploration is limited to about 60 to 70 percent of the skin depth of the surrounding rock or soil. Therefore, the high frequency of the VLF transmitters means that in more conductive environments the exploration depth is quite shallow; for example, the depth of exploration might be 10-12 m in 25- $\Omega$ m material. Additionally, the presence of conductive overburden seriously suppresses response from basement conductors while relatively small variations in overburden conductivity or thickness can themselves generate significant VLF anomalies. For this reason, VLF is more effective in areas where the host rock is resistive and the overburden is thin.

*b. VLF interpretation.*

(1) VLF response is a maximum when the target strikes in the direction of the transmitter, falling off roughly as the cosine of the strike angle for other directions. However, there are a number of transmitters worldwide and seldom is the selection of an appropriate transmitter a problem. Because of the rudimentary nature of VLF measurements, simple interpretational techniques suffice for most practical purposes. The conductor is located horizontally at the inflection point marking the crossover from positive tilt to negative tilt and the maximum in field strength. A rule-of-thumb depth estimate can be made from the distance between the positive and negative peaks in the tilt angle profile.

(2) One cannot make reliable estimates of conductor quality, however. Finally, the major disadvantage of the VLF method is that the high frequency results in a multitude of anomalies from unwanted sources such as swamp edges, creeks and topographic highs. A VLF receiver measures the field tilt and hence the tilt profile shown in Figure 4-58 (Klein and Lajoie 1980). Figure 4-58 also shows schematically how the secondary field from the conductor is added to the primary field vector so that the resultant field is tilted up on one side of the conductor and down on the other side. Some receivers measure other parameters such as the relative amplitude of the total field or any component and the phase between any two components. Figure 4-59 (Klein and Lajoie 1980) shows a comparison of the main types of measurements made with different VLF receivers. A variant of VLF measures the electric field with a pair of electrodes simultaneously with the tilt measurement.

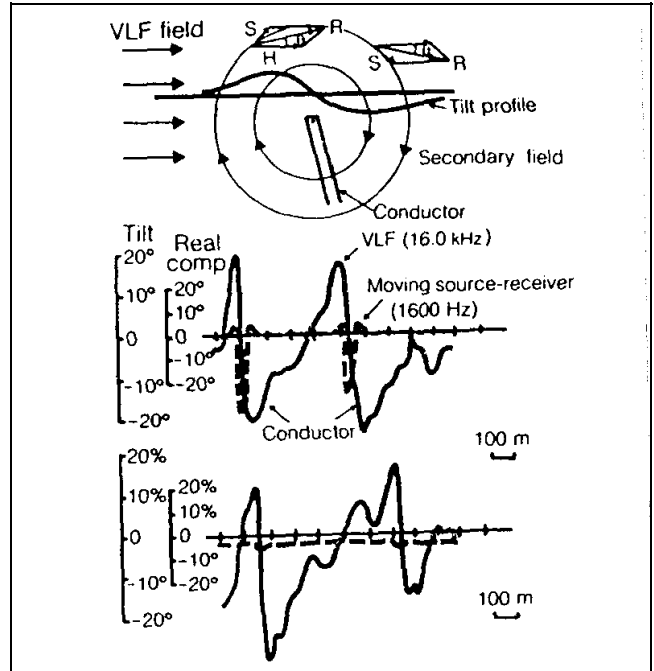

Figure 4-58. Tilt of the VLF field vector over a conductor (Klein and Lajoie 1980; copyright permission granted by Northwest Mining Association and Klein)

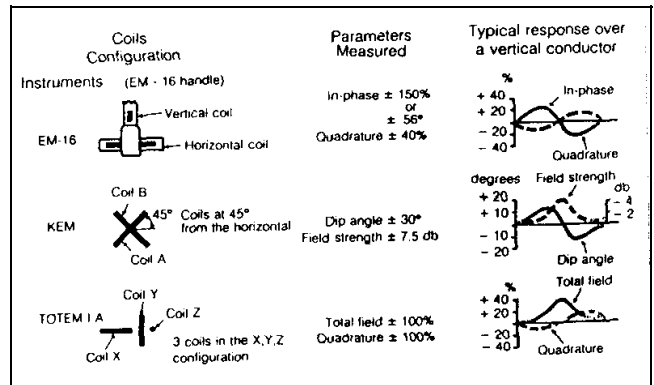
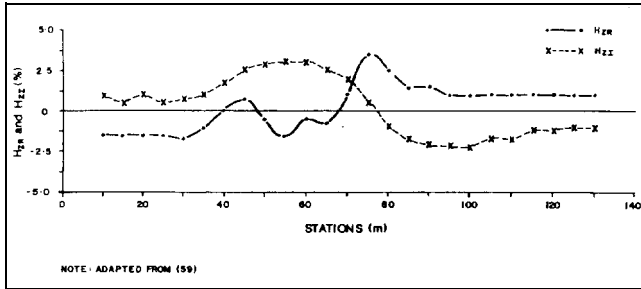

Figure 4-59. Comparison of VLF instruments (Klein and Lajoie 1980; copyright permission granted by Northwest Mining Association and Klein)

*c. VLF examples.*

(1) Groundwater study. Figure 4-60 presents VLF results taken over granite terrain in Burkina Faso, Africa (Wright (1988), after Palacky, Ritsema, and De Jong (1981)). The objective of the survey was to locate depressions in the granite bedrock which could serve as catchments for groundwater. Depressions in the very

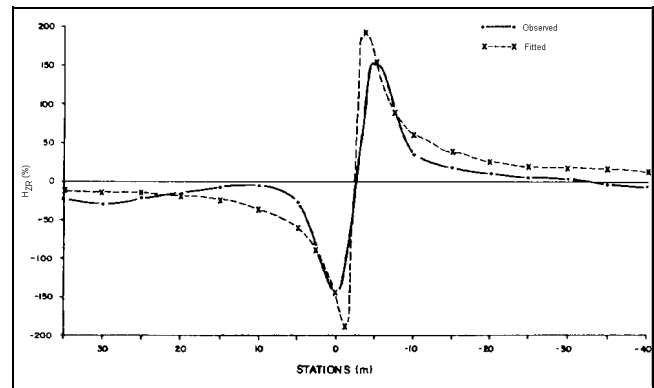

**Figure 4-60. VLF profile, Burkina Faso, Africa (Wright 1988; copyright permission granted by Scintrex)**

resistive bedrock beneath poorly conductive overburden (100 to 300  $\Omega\text{m}$  at this site) likely produce VLF responses as a result of galvanic current flow. That is, the large current sheet flowing in the overburden, as a result of the primary electric field, is channelled along these bedrock depressions and appears as a line of anomalous current. The conductor axis is centered near station 70 to 75. A water well was drilled at station 70 and encountered bedrock beneath approximately 20 m of overburden and flowed at a rate of 1.0  $\text{m}^3/\text{hour}$ .

(2) Detection of buried cables. Figure 4-61 presents VLF measurements along a profile crossing a buried telephone line (Wright 1988). A classic crossover is

observed which places the line beneath station -2.5. However, this curve is a good example of a poorly sampled response, because the exact peaks on the profile are probably not determined. One possible model is presented on Figure 4-61 for a line current at a depth of 1.25 m and station -2.5. The fit is only fair, which could be the result of poor station control, inapplicability of the line current model, or distortion of the measured profile by adjacent responses.



**Figure 4-61. VLF profile over buried telephone line (Wright 1988; copyright permission granted by Scintrex)**



## Chapter 5 Gravity Techniques

### 5-1. Introduction

Lateral density changes in the subsurface cause a change in the force of gravity at the surface. The intensity of the force of gravity due to a buried mass difference (concentration or void) is superimposed on the larger force of gravity due to the total mass of the earth. Thus, two components of gravity forces are measured at the earth's surface: first, a general and relatively uniform component due to the total earth, and second, a component of much smaller size which varies due to lateral density changes (the gravity anomaly). By very precise measurement of gravity and by careful correction for variations in the larger component due to the whole earth, a gravity survey can sometimes detect natural or man-made voids, variations in the depth to bedrock, and geologic structures of engineering interest.

### 5-2. Applications

For engineering and environmental applications, the scale of the problem is generally small (targets are often from 1-10 m in size). Therefore, conventional gravity measurements, such as those made in petroleum exploration, are inadequate. Station spacings are typically in the range of 1-10 m. Even a new name, microgravity, was invented to describe the work. Microgravity requires preserving all of the precision possible in the measurements and analysis so that small objects can be detected.

*a.* Gravity surveys are limited by ambiguity and the assumption of homogeneity discussed in paragraph 2-1b(3).

(1) A distribution of small masses at a shallow depth can produce the same effect as a large mass at depth. External control of the density contrast or the specific geometry is required to resolve ambiguity questions. This external control may be in the form of geologic plausibility, drill-hole information, or measured densities.

(2) The first question to ask when considering a gravity survey is "For the current subsurface model, can the resultant gravity anomaly be detected?". Inputs required are the probable geometry of the anomalous region, its depth of burial, and its density contrast. A generalized rule of thumb is that a body must be almost as big as it is deep. To explore this question Figure 5-1

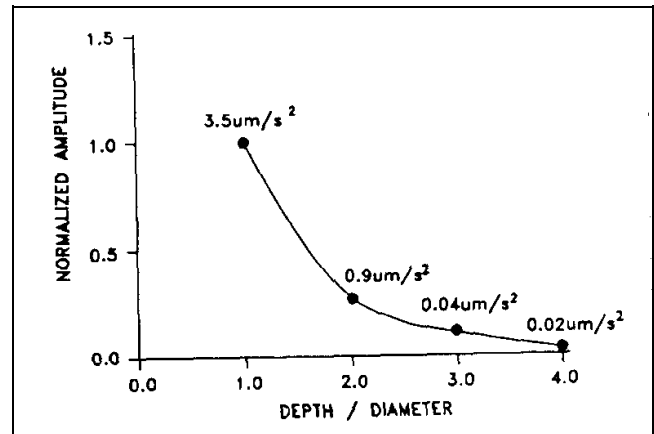

**Figure 5-1. Normalized peak vertical attraction versus depth-to-diameter ratio for a spherical body. Values are for a 10-m sphere with a 1.0-g/cc density contrast.**

was prepared. The body under consideration is a sphere. The vertical axis is normalized to the attraction of a sphere whose center is at a depth equal to its diameter. For illustration, the plotted values give the actual gravity values for a sphere 10 m in diameter with a 1,000 kg/m<sup>3</sup> (1.0 g/cc) density contrast. The horizontal axis is the ratio of depth to diameter. The rapid decrease in value with depth of burial is evident. At a ratio of depth to diameter greater than 2.0, the example sphere falls below the practical noise level for most surveys as will be discussed below.

(2) A second guideline or rule of thumb is that unless you are very close to the body its exact shape is not important. Thus, a rectangular-shaped horizontal tunnel can be modeled by a horizontal circular cylinder and a horizontal cylinder sometimes can be modeled by a horizontal line source. Odd-shaped rooms can be modeled by disks and where close to the surface, even infinite or semi-infinite slabs.

*b.* Among the many useful nomograms and charts that are available, Figure 5-2 (which is adapted from Arzi (1975)), is very practical. The gravity anomaly is linear with density contrast so other density contrasts can be evaluated by scaling the given curves. For cylinders of finite length very little correction is needed unless the cylinder length is less than four times its width. Nettleton (1971) gives the correction formula for finite length of cylinders. A useful simple formula is the one for an infinite slab. This formula is:

$$A_z = 2\pi G t \Delta p_b \quad (5-1)$$

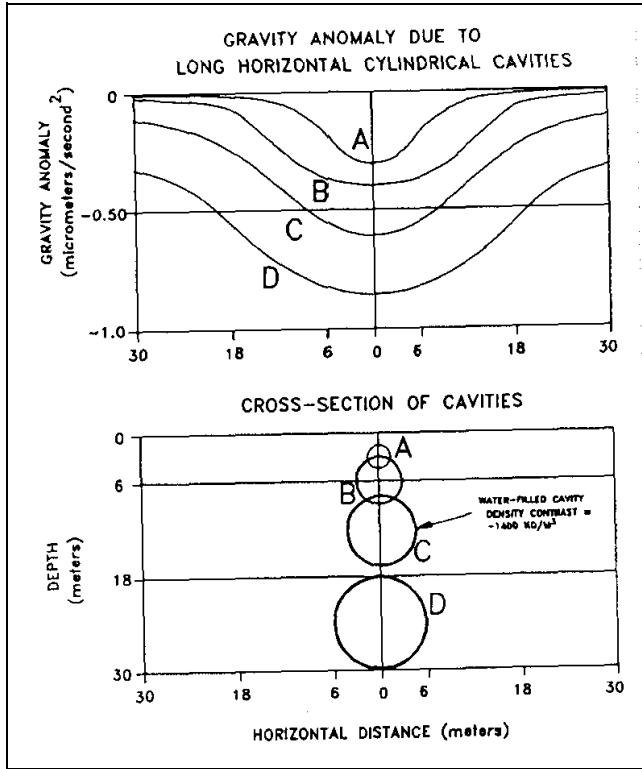

Figure 5-2. Gravity anomalies for long horizontal cylindrical cavities as a function of depth, size, and distance from peak

where

$$A_z = \text{vertical attraction, } \mu\text{m/s}^2 \text{ (} 1 \mu\text{m/s}^2 = 10^{-6} \text{ m/s}^2 \\ = 10^{-4} \text{ cm/s} = 10^{-4} \text{ gal} = 10^2 \mu\text{gal)}$$

$$G = 0.668 \times 10^{-4}, \text{ Universal Gravitational Constant} \\ \text{in } \{ \text{m}^3 / [\text{kg} \cdot \text{s}^2] \} 10^{-6}$$

$$t = \text{thickness, m}$$

$$\Delta p_b = \text{density contrast, kg/m}^3$$

As an example, consider a 1-m-thick sheet with a density contrast with its surroundings twice that of water. From Equation 5-1, the calculation would be  $A_z = 2\pi(0.668 \times 10^{-4})(1.0)(2,000) \mu\text{m/s}^2 = 0.84 \mu\text{m/s}^2$ .

c. A surprising result from potential theory is that there is no distance term in this formula. The intuitive objections can be quelled by focusing on the fact that the slab is infinite in all directions. The usefulness of this formula increases if one recognizes that the attraction of a semi-infinite slab is given by one-half of the above formula at the edge of the slab. Thus near the edge of a

fault or slab-like body, the anomaly will change from zero far away from the body to  $(2\pi G t \Delta p_b)$  at a point over the body and far away from the edge (above the edge the value is  $G\pi t \Delta p_b$ ). This simple formula can be used to quickly estimate the maximum response from a slab-type anomaly. If the maximum due to the infinite sheet is not detectable then complicated calculations with finite bodies are not justified. Nettleton (1971) is a good source of formulas that can be used to approximate actual mass distributions.

d. Items which should not be overlooked in estimating the probable density contrast are:

- (1) Variability (1,000 to 3,500 kg/m<sup>3</sup>) of the density of rocks and soils.
- (2) Possibility of fractures and weathering in rocks.
- (3) Probability of water filling in voids.

Each of these items should be individually considered before a density contrast is set. The effects of upward-propagating fractures, which can move a mass deficiency nearer the surface, and the presence or absence of air pockets usually cannot be evaluated if one is after subsurface mass deficiencies. However, these effects will increase the amplitude of the anomaly, sometimes by a factor of two or more.

### 5-3. Noise Evaluation

Usually more important in a feasibility study than the anomaly evaluation is the estimation of the noise sources expected. This section will discuss the larger contributions to noise and evaluate each.

a. Modern instruments have a least-significant scale reading of  $0.01 \mu\text{m/s}^2$ . However, repeated readings including moving the meter, releveling, and unclamping the beam several times indicate an irreducible meter reading error of about  $\pm 0.05 \mu\text{m/s}^2$ . New electronically augmented versions of these meters consistently repeat to  $\pm 0.02\text{-}0.03 \mu\text{m/s}^2$ . Some surveys may do slightly better, but one should be prepared to do worse. Factors which may significantly increase this type of error are soft footing for the gravimeter plate (surveys have been done on snow), wind, and ground movement (trucks, etc.) in the frequency range of the meter. Again, the special versions of these meters which filter the data appropriately can compensate for some of these effects. A pessimist, with all of the above factors in action, may allow  $\pm 0.08$  to  $0.1 \mu\text{m/s}^2$  for reading error.

b. Gravity measurements, even at a single location, change with time due to earth tides, meter drift, and tares. These time variations can be dealt with by good field procedure. The earth tide may cause changes of  $2.4 \mu\text{m/s}^2$  in the worst case but it has period of about 12.5 hr; it is well approximated as a straight line over intervals of 1-2 hr or it can be calculated and removed. Drift is also well eliminated by linear correction. Detection of tares and blunders (human inattention) is also a matter of good field technique and repeated readings. One might ascribe 10-20  $\text{nm/s}^2$  to these error sources, when these errors are estimated.

(1) Additional errors can occur during the data correction process. Three major contributions to the gravity field at a station are corrected by processing. Details of the free air, Bouguer slab and terrain corrections will not be expressed here (see Blizkovsky (1979)), but the formula will be given.

(a) The smooth latitude dependence of gravity is given by the following equation:

$$g = 9.780318 \text{ m/s}^2 (1 + 0.0053024 \sin^2\phi - 0.0000059 \sin^2\phi) \quad (5-2)$$

where

$g$  = acceleration of gravity in  $\text{m/s}^2$

$\phi$  = latitude in decimal degrees

Calculations will show that if the stations are located with less than 0.5 to 1.0 m of error, the error in the latitude variation is negligible. In fact, for surveys of less than 100 m north to south, this variation is often considered part of the regional and removed in the interpretation step. Where larger surveys are considered, the above formula gives the appropriate correction.

(b) The free-air and the Bouguer-slab are corrected to a datum by the following formula (the datum is an arbitrary plane of constant elevation to which all the measurements are referenced):

$$G_s = G_{OBS} [1 + (3.086 - 0.000421\Delta p_b) \Delta h] \quad (5-3)$$

where

$G_s$  = simple Bouguer corrected gravity value measured in  $\mu\text{m/s}^2$

$G_{OBS}$  = observed gravity value in  $\mu\text{m/s}^2$

$\Delta p_b$  = near-surface density of the rock in  $\text{kg/m}^3$

$\Delta h$  = elevation difference between the station and datum in m

(c) If these formulae were analyzed, see that the elevation correction is about 20  $\text{nm/s}^2$  per cm. It is impractical in the field to require better than  $\pm 1$ -1.5 cm leveling across a large site, so  $\pm 30$ -40  $\text{nm/s}^2$  of error is possible due to uncertainty in the relative height of the stations and the meter at each station.

(d) The formula for free air and Bouguer corrections contains a surface density value in the formulas. If this value is uncertain by  $\pm 10$  percent, its multiplication times  $\Delta h$  can lead to error. Obviously, the size of the error depends on  $\Delta h$ , the amount of altitude change necessary to bring all stations to a common level. The size of the  $\Delta h$  for each station is dependent on surface topography. For a topographic variation of  $\pm 1$  m (a very flat site!) the 10-percent error in the near surface density corresponds to  $\pm 60 \text{ nm/s}^2$ . For a  $\pm 10$ -m site, the error is  $\pm 0.6 \mu\text{m/s}^2$ . All of these estimates are based on a mistaken estimate of the near surface-density, not the point-to-point variability in density, which also may add to the error term.

(2) The terrain effect (basically due to undulations in the surface near the station) has two components of error. One error is based on the estimate of the amount of material present above and absent below an assumed flat surface through the station. This estimate must be made quite accurately near the station; farther away some approximation is possible. In addition to the creation of the geometric model, a density estimate is also necessary for terrain correction. The general size of the terrain corrections for stations on a near flat ( $\pm 3$ -m) site the size of tens of acres might be  $1 \mu\text{m/s}^2$ . A 10-percent error in the density and the terrain model might produce  $\pm 0.1 \mu\text{m/s}^2$  of error. This estimate does not include terrain density variations. Even if known, such variations are difficult to apply as corrections.

c. To summarize, a site unsuited for microgravity work (which contains variable surface topography and variable near-surface densities) might produce 0.25-0.86  $\mu\text{m/s}^2$  of difficult-to-reduce error.

#### 5-4. Rock Properties

Values for the density of shallow materials (also note Table 3-1) are determined from laboratory tests of boring

and bag samples. Density estimates may also be obtained from geophysical well logging (see paragraph 7-1k(11)). Table 5-1 lists the densities of representative rocks. Densities of a specific rock type on a specific site will not have more than a few percent variability as a rule (vuggy limestones being one exception). However, unconsolidated materials such as alluvium and stream channel materials may have significant variation in density.

**5-5. Field Work**

*a. General.*

(1) Up to 50 percent of the work in a microgravity survey is consumed in the surveying. For the very precise work described above, relative elevations for all stations need to be established to  $\pm 1$  to 2 cm. A firmly fixed stake or mark should be used to allow the gravity meter reader to recover the exact elevation. Position in plan is less critical, but relative position to 50-100 cm or 10 percent of the station spacing (whichever is smaller) is usually sufficient. Satellite surveying, GPS, can achieve the required accuracy, especially the vertical accuracy, only with the best equipment under ideal conditions.

(2) High station densities are often required. It is not unusual for intervals of 1-3 m to be required to map anomalous masses whose maximum dimension is 10 m. Because the number of stations in a grid goes up as the square of the number of stations on one side, profiles are often used where the attitude of the longest dimension of the sought body can be established before the survey begins.

(3) After elevation and position surveying, actual measurement of the gravity readings is often accomplished by one person in areas where solo work is allowed. Because of short-term variations in gravimeter readings caused by less than perfect elasticity of the moving parts of the suspension, by uncompensated environmental effects, and by the human operator, it is necessary to improve the precision of the station readings by repetition. The most commonly used survey technique is to choose one of the stations as a base and to reoccupy that base periodically throughout the working day. The observed base station gravity readings are then plotted versus time, and a line is fitted to them to provide time rates of drift for the correction of the remainder of the observations. Typically eight to ten measurements can be made between base station occupations; the time between base readings should be on the order of 1-2 hr. Where higher precision is required, each station must be reoccupied at least once during the survey.

**Table 5-1**  
**Density Approximations for Representative Rock Types**

Rock Type	Number of Samples	Density	
		Mean (kg/m <sup>3</sup> )	Range (kg/m <sup>3</sup> )
<b>Igneous Rocks</b>			
Granite	155	2,667	2,516-2,809
Granodiorite	11	2,716	2,668-2,785
Syenite	24	2,757	2,630-2,899
Quartz Diorite	21	2,806	2,680-2,960
Diorite	13	2,839	2,721-2,960
Gabbro (olivine)	27	2,976	2,850-3,120
Diabase	40	2,965	2,804-3,110
Peridotite	3	3,234	3,152-3,276
Dunite	15	3,277	3,204-3,314
Pyroxenite	8	3,231	3,100-3,318
Anorthosite	12	2,734	2,640-2,920
Rhyolite obsidian	15	2,370	2,330-2,413
Basalt glass	11	2,772	2,704-2,851
<b>Sedimentary Rocks</b>			
Sandstone			
St. Peter	12	2,500	
Bradford	297	2,400	
Berea	18	2,390	
Cretaceous, Wyo.	38	2,320	
Limestone			
Glen Rose	10	2,370	
Black River	11	2,720	
Ellenberger	57	2,750	
Dolomite			
Beckmantown	56	2,800	
Niagara	14	2,770	
Marl (Green River)	11	2,260	
Shale			
Pennsylvania		2,420	
Cretaceous	9	2,170	
Silt (loess)	3	1,610	
Sand			
Fine	54	1,930	
Very fine	15	1,920	
Silt-sand-clay			
Hudson River	3	1,440	
<b>Metamorphic Rocks</b>			
Gneiss (Vermont)	7	2,690	2,660-2,730
Granite Gneiss			
Austria	19	2,610	2,590-2,630
Gneiss (New York)	25	2,840	2,700-3,060
Schists			
Quartz-mica	76	2,820	2,700-2,960
Muscovite-biotite	32	2,760	
Chlorite-sericite	50	2,820	2,730-3,030
Slate (Taconic)	17	2,810	2,710-2,840
Amphibolite	13	2,990	2,790-3,140

(a) If even higher precision is desired or if instrumental drift is large in comparison with the expected gravity anomaly, then a leapfrogging of stations can be used. For example, if the stations are in an order given by a,b,c,d,e,f,... then the station occupations might be in the sequence ab, abc, abcd, bcde, cdef, defg, etc. In this way, each station would be occupied four times. Numerical adjustments, such as least squares minimization of deviations, may be applied to reoccupation data sets. This procedure allows data quality to be monitored and controlled and distributes any systematic errors throughout the grid.

(b) If base reoccupations are done approximately every hour, known errors such as the earth tide are well approximated by the removal of a drift correction that is linear with time. Even if the theoretical earth tide is calculated and removed, any residual effects are removed along with instrumental drift by frequent base station reoccupation.

*b. Analysis.* Once the basic free-air, Bouguer, terrain, and latitude corrections are made, an important step in the analysis remains. This step, called regional-residual separation, is one of the most critical. In most surveys, and in particular those engineering applications in which very small anomalies are of greatest interest, there are gravity anomaly trends of many sizes. The larger sized anomalies will tend to behave as regional variations and the desired smaller magnitude local anomalies will be superimposed on them. A simple method of separating residual anomalies from microregional variations is simply to visually smooth contour lines or profiles and subtract this smoother representation from the reduced data. The remainder will be a residual anomaly representation. However, this method can sometimes produce misleading or erroneous results.

(1) Several automatic versions of this smoothing procedure are available including polynomial surface fitting and band-pass filtering. The process requires considerable judgement and whichever method is used should be applied by an experienced interpreter.

(2) Note that certain unavoidable errors in the reduction steps may be removed by this process. Any error which is slowly varying over the entire site, such as a distant terrain or erroneous density estimates, may be partially compensated by this step. The objective is to isolate the anomalies of interest. Small wavelength (about 10 m) anomalies may be riding on equally anomalous measurements with wavelengths of 100 or 1,000 m. The scale of the problem guides the regional-residual separation.

*c. Interpretation.*

(1) Software packages for the interpretation of gravity data are plentiful and powerful. The ease of use as determined by the user interface may be the most important part of any package. The usual inputs are the residual gravity values along a profile or traverse. The traverse may be selected from a grid of values along an orientation perpendicular to the strike of the suspected anomalous body. Some of the programs allow one additional chance for residual isolation. The interpreter then constructs a subsurface polygonal-shaped model and assigns a density contrast to it. When the trial body has been drawn, the computer calculates the gravity effect of the trial body and shows a graphical display of the observed data, the calculated data due to the trial body and often the difference. The geophysicist can then begin varying parameters in order to bring the calculated and observed values closer together. Parameters usually available for variation are the vertices of the polygon, the length of the body perpendicular to the traverse, and the density contrast. Most programs also allow multiple bodies.

(2) Because recalculation is done quickly (many programs work instantaneously as far as humans are concerned), the interpreter can rapidly vary the parameters until an acceptable fit is achieved. Additionally, the effects of density variations can be explored and the impact of ambiguity evaluated.

*d. Case study.* In order to illustrate the practical results of the above theoretical evaluations, two examples were prepared. The geologic section modeled is a coal bed of density  $2,000 \text{ kg/m}^3$  and 2 m thickness. This bed, 9 m below the surface, is surrounded by country rock of density  $2,200 \text{ kg/m}^3$ . A water-filled cutout 25 m long and an air-filled cutout 12 m long are present. The cutouts are assumed infinite perpendicular to the cross-section shown at the bottom of Figure 5-3. The top of Figure 5-3 illustrates the theoretical gravity curve over this geologic section. The middle curve is a simulation of a measured field curve. Twenty-two hundredths of a  $\mu\text{m/s}^2$  of random noise have been added to the values from the top curve as an illustration of the effect of various error sources. The anomalies are visible but quantitative separation from the noise might be difficult.

(1) Figure 5-4 is the same geologic section but the depth of the coal workings is 31 m. The anomalies are far more subtle (note scale change) and, when the noise is added, the anomalies disappear.

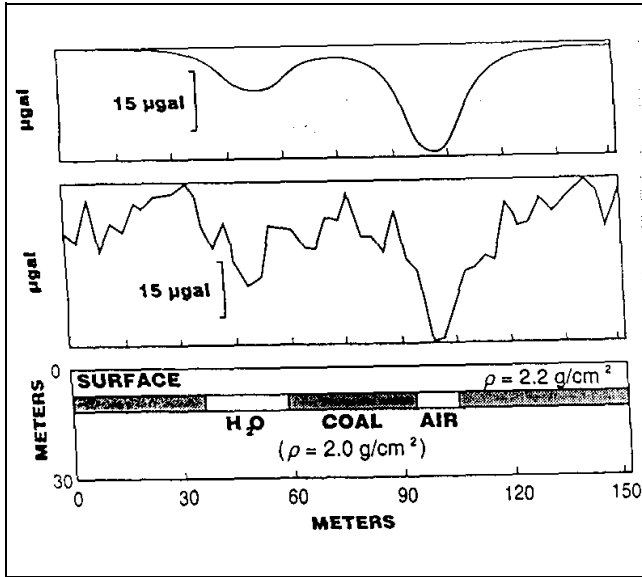

Figure 5-3. Geological model (bottom) including water and air-filled voids; theoretical gravity anomaly (top) due to model; and possible observed gravity (middle), if 22 microgals ( $0.22 \mu\text{m/s}^2$ ) of noise is present. Depth of layer is 10 m

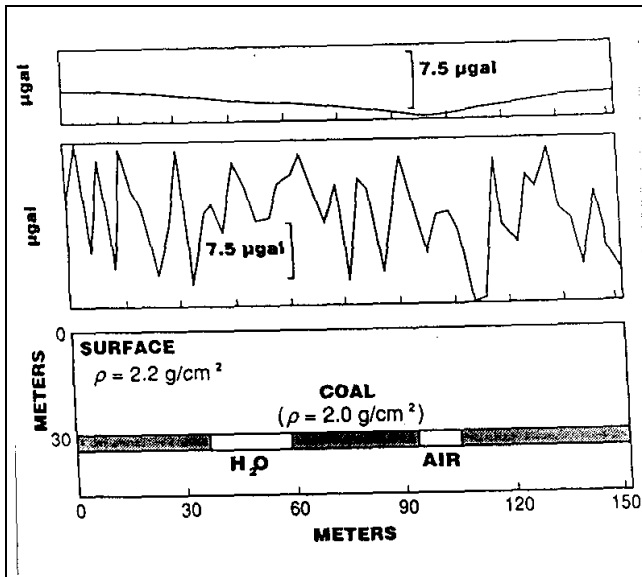

Figure 5-4. Geological model (bottom) including water and air-filled voids, theoretical gravity anomaly (top) due to model; and possible observed gravity (middle), if 22 microgals ( $0.22 \mu\text{m/s}^2$ ) of noise is present. Depth of layer is 31 m

(2) For the two cases given, Figure 5-3 represents a clearly marginal case. Several points need to be

discussed. The noise added represents a compromise value. In a hilly eastern coal field on a rainy day,  $0.22 \mu\text{m/s}^2$  of error is optimistic. On a paved parking lot or level tank bottom, the same error estimate is too high. Note that the example uses random noise, while the errors discussed above (soil thickness variations, etc.) will be correlated over short distances.

(3) Another point is the idea of fracture migration or a halo effect. Some subsidence usually occurs over voids, or, in the natural case, the rock near caves may be reduced in density (Butler 1984). The closer to the gravimeter these effects occur, the more likely is detection.

(4) Figure 5-5 illustrates a high precision survey over a proposed reservoir site. The large size of the fault and its proximity to the surface made the anomaly large enough to be detected without the more rigorous approach of microgravity. The area to the east is shown to be free of faulting (at least at the scale of tens of meters of throw) and potentially suitable as a reservoir site.

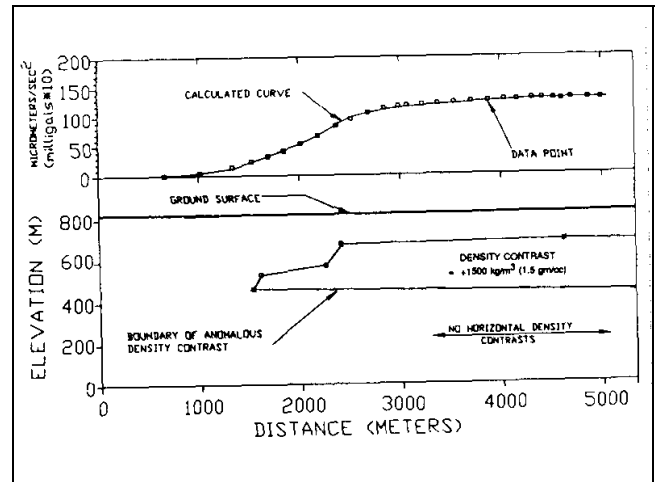

Figure 5-5. Gravity traverses and interpreted models

*e. Conclusions.*

In addition to anomaly evaluation, the source and size of the irreducible field errors must be considered. Under the proper conditions of large enough anomalies, good surface conditions, and some knowledge of densities, microgravity can be an effective tool for engineering investigations.

## Chapter 6 Magnetic Methods

### 6-1. Introduction

*a.* The earth possesses a magnetic field caused primarily by sources in the core. The form of the field is roughly the same as would be caused by a dipole or bar magnet located near the earth's center and aligned sub-parallel to the geographic axis. The intensity of the earth's field is customarily expressed in S.I. units as nanoteslas (nT) or in an older unit, gamma ( $\gamma$ ):  $1 \gamma = 1 \text{ nT} = 10^{-3} \mu\text{T}$ . Except for local perturbations, the intensity of the earth's field varies between about 25 and 80  $\mu\text{T}$  over the coterminous United States.

*b.* Many rocks and minerals are weakly magnetic or are magnetized by induction in the earth's field, and cause spatial perturbations or "anomalies" in the earth's main field. Man-made objects containing iron or steel are often highly magnetized and locally can cause large anomalies up to several thousands of nT. Magnetic methods are generally used to map the location and size of ferrous objects. Determination of the applicability of the magnetics method should be done by an experienced engineering geophysicist. Modeling and incorporation of auxiliary information may be necessary to produce an adequate work plan.

### 6-2. Theory

The earth's magnetic field dominates most measurements on the surface of the earth. The earth's total field intensity varies considerably by location over the surface of the earth. Most materials except for permanent magnets, exhibit an induced magnetic field due to the behavior of the material when the material is in a strong field such as the earth's. Induced magnetization (sometimes called magnetic polarization) refers to the action of the field on the material wherein the ambient field is enhanced causing the material itself to act as a magnet. The field caused by such a material is directly proportional to the intensity of the ambient field and to the ability of the material to enhance the local field, a property called magnetic susceptibility. The induced magnetization is equal to the product of the volume magnetic susceptibility and the inducing field of the earth:

$$I = k F \quad (6-1)$$

where

$k$  = volume magnetic susceptibility (unitless)

$I$  = induced magnetization per unit volume

$F$  = field intensity in tesla (T)

*a.* For most materials  $k$  is much less than 1 and, in fact, is usually of the order of  $10^{-6}$  for most rock materials. The most important exception is magnetite whose susceptibility is about 0.3. From a geologic standpoint, magnetite and its distribution determine the magnetic properties of most rocks. There are other important magnetic minerals in mining prospecting, but the amount and form of magnetite within a rock determines how most rocks respond to an inducing field. Iron, steel, and other ferromagnetic alloys have susceptibilities one to several orders of magnitude larger than magnetite. The exception is stainless steel, which has a small susceptibility.

*b.* The importance of magnetite cannot be exaggerated. Some tests on rock materials have shown that a rock containing 1 percent magnetite may have a susceptibility as large as  $10^{-3}$ , or 1,000 times larger than most rock materials. Table 6-1 provides some typical values for rock materials. Note that the range of values given for each sample generally depends on the amount of magnetite in the rock.

**Table 6-1**  
**Approximate Magnetic Susceptibility of Representative Rock Types**

Rock Type	Susceptibility ( $k$ )
Altered ultra basics	$10^{-4}$ to $10^{-2}$
Basalt	$10^{-4}$ to $10^{-3}$
Gabbro	$10^{-4}$
Granite	$10^{-5}$ to $10^{-3}$
Andesite	$10^{-4}$
Rhyolite	$10^{-5}$ to $10^{-4}$
Metamorphic rocks	$10^{-4}$ to $10^{-6}$
Most sedimentary rocks	$10^{-6}$ to $10^{-5}$
Limestone and chert	$10^{-6}$
Shale	$10^{-5}$ to $10^{-4}$

*c.* Thus it can be seen that in most engineering and environmental scale investigations, the sedimentary and alluvial sections will not show sufficient contrast such that magnetic measurements will be of use in mapping the geology. However, the presence of ferrous materials in ordinary municipal trash and in most industrial waste does allow the magnetometer to be effective in direct detection of landfills. Other ferrous objects which may be detected include pipelines, underground storage tanks, and some ordnance.

### 6-3. Field Work

Ground magnetic measurements are usually made with portable instruments at regular intervals along more or less straight and parallel lines which cover the survey area. Often the interval between measurement locations (stations) along the lines is less than the spacing between lines.

*a.* The magnetometer is a sensitive instrument which is used to map spatial variations in the earth's magnetic field. In the proton magnetometer, a magnetic field which is not parallel to the earth's field is applied to a fluid rich in protons causing them to partly align with this artificial field. When the controlled field is removed, the protons precess toward realignment with the earth's field at a frequency which depends on the intensity of the earth's field. By measuring this precession frequency, the total intensity of the field can be determined. The physical basis for several other magnetometers, such as the cesium or rubidium-vapor magnetometers, is similarly founded in a fundamental physical constant. The optically pumped magnetometers have increased sensitivity and shorter cycle times (as small as 0.04 s) making them particularly useful in airborne applications.

(1) The incorporation of computers and non-volatile memory in magnetometers has greatly increased the ease of use and data handling capability of magnetometers. The instruments typically will keep track of position, prompt for inputs, and internally store the data for an entire day of work. Downloading the information to a personal computer is straightforward and plots of the day's work can be prepared each night.

(2) To make accurate anomaly maps, temporal changes in the earth's field during the period of the survey must be considered. Normal changes during a day, sometimes called diurnal drift, are a few tens of nT but changes of hundreds or thousands of nT may occur over a few hours during magnetic storms. During severe magnetic storms, which occur infrequently, magnetic surveys should not be made. The correction for diurnal drift can be made by repeat measurements of a base station at frequent intervals. The measurements at field stations are then corrected for temporal variations by assuming a linear change of the field between repeat base station readings. Continuously recording magnetometers can also be used at fixed base sites to monitor the temporal changes. If time is accurately recorded at both base site and field location, the field data can be corrected by subtraction of the variations at the base site.

(3) The base-station memory magnetometer, when used, is set up every day prior to collection of the magnetic data. The base station ideally is placed at least 100 m from any large metal objects or travelled roads and at least 500 m from any power lines when feasible. The base station location must be very well described in the field book as others may have to locate it based on the written description.

(4) Some QC/QA procedures require that several field-type stations be occupied at the start and end of each day's work. This procedure indicates that the instrument is operating consistently. Where it is important to be able to reproduce the actual measurements on a site exactly (such as in certain forensic matters) an additional procedure is required. The value of the magnetic field at the base station must be asserted (usually a value close to its reading on the first day) and each day's data corrected for the difference between the asserted value and the base value read at the beginning of the day. As the base may vary by 10-25 nT or more from day to day, this correction ensures that another person using the SAME base station and the SAME asserted value will get the same readings at a field point to within the accuracy of the instrument. This procedure is always good technique but is often neglected by persons interested in only very large anomalies (> 500 nT, etc.).

*b.* Intense fields from man-made electromagnetic sources can be a problem in magnetic surveys. Most magnetometers are designed to operate in fairly intense 60-Hz and radio frequency fields. However extremely low frequency fields caused by equipment using direct current or the switching of large alternating currents can be a problem. Pipelines carrying direct current for cathodic protection can be particularly troublesome. Although some modern ground magnetometers have a sensitivity of 0.1 nT, sources of cultural and geologic noise usually prevent full use of this sensitivity in ground measurements.

(1) After all corrections have been made, magnetic survey data are usually displayed as individual profiles or as contour maps. Identification of anomalies caused by cultural features, such as railroads, pipelines, and bridges is commonly made using field observations and maps showing such features.

(2) For some purposes a close approximation of the gradient of the field is determined by measuring the difference in the total field between two closely spaced



sensors. The quantity measured most commonly is the vertical gradient of the total field.

(3) The magnetometer is operated by a single person. However, grid layout, surveying, or the buddy system may require the use of another technician. If two magnetometers are available production is usually doubled as the ordinary operation of the instrument itself is straightforward.

*c. Distortion.*

(1) Steel and other ferrous metals in the vicinity of a magnetometer can distort the data. Large belt buckles, etc., must be removed when operating the unit. A compass should be more than 3 m away from the magnetometer when measuring the field. A final test is to immobilize the magnetometer and take readings while the operator moves around the sensor. If the readings do not change by more than 1 or 2 nT, the operator is "magnetically clean." Zippers, watches, eyeglass frames, boot Grommets, room keys, and mechanical pencils, can all contain steel or iron. On very precise surveys, the operator effect must be held under 1 nT.

(2) To obtain a representative reading, the sensor should be operated well above the ground. This procedure is done because of the probability of collections of soil magnetite disturbing the reading near the ground. In rocky terrain where the rocks have some percentage of magnetite, sensor heights of up to 4 m have been used to remove near-surface effects. One obvious exception to this is some types of ordnance detection where the objective is to detect near-surface objects. Often a rapid-reading magnetometer is used (cycle time less than 1/4 s) and the magnetometer is used to sweep across an area near the ground. Small ferrous objects can be detected, and spurious collections of soil magnetite can be recognized by their lower amplitude and dispersion. Ordnance detection requires not only training in the recognition of dangerous objects, but experience in separating small, intense, and interesting anomalies from more dispersed geologic noise.

*d. Data recording methods will vary with the purpose of the survey and the amount of noise present. Methods include: taking three readings and averaging the results, taking three readings within a meter of the station and either recording each or recording the average. Some magnetometers can apply either of these methods and even do the averaging internally. An experienced field geophysicist will specify which technique is required for a given survey. In either case, the time of the reading is*

also recorded unless the magnetometer stores the readings and times internally.

(1) Sheet-metal barns, power lines, and other potentially magnetic objects will occasionally be encountered during a magnetic survey. When taking a magnetic reading in the vicinity of such items, describe the interfering object and note the distance from it to the magnetic station in your field book.

(2) Items to be recorded in the field book for magnetics:

(a) Station location, including locations of lines with respect to permanent landmarks or surveyed points.

(b) Magnetic field and/or gradient reading.<sup>1</sup>

(c) Time.<sup>1</sup>

(d) Nearby sources of potential interference.

(3) The experienced magnetics operator will be alert for the possible occurrence of the following conditions:

(a) Excessive gradients may be beyond the magnetometer's ability to make a stable measurement. Modern magnetometers give a quality factor for the reading. Multiple measurements at a station, minor adjustments of the station location and other adjustments of technique may be necessary to produce repeatable, representative data.

(b) Nearby metal objects may cause interference. Some items, such as automobiles, are obvious, but some subtle interference will be recognized only by the imaginative and observant magnetics operator. Old buried curbs and foundations, buried cans and bottles, power lines, fences, and other hidden factors can greatly affect magnetic readings.

*e. Interpretation.* Total magnetic disturbances or anomalies are highly variable in shape and amplitude; they are almost always asymmetrical, sometimes appear complex even from simple sources, and usually portray the combined effects of several sources. An infinite number of possible sources can produce a given anomaly, giving rise to the term ambiguity.

---

<sup>1</sup> Optional depending on use of memory magnetometers which record these parameters and the station number.

(1) One confusing issue is the fact that most magnetometers used measure the total field of the earth: no oriented system is recorded for the total field amplitude. The consequence of this fact is that only the component of an anomalous field in the direction of earth's main field is measured. Figure 6-1 illustrates this consequence of the measurement system. Anomalous fields that are nearly perpendicular to the earth's field are undetectable.

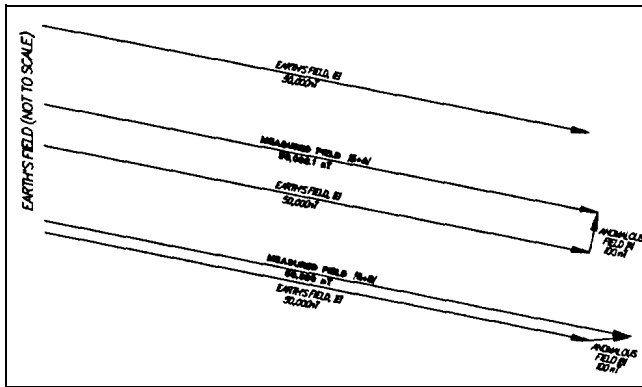

Figure 6-1. Magnetic field vector examples for two anomalous targets

(2) Additionally, the induced nature of the measured field makes even large bodies act as dipoles; that is, like a large bar magnet. If the (usual) dipolar nature of the anomalous field is combined with the measurement system that measures only the component in the direction of the earth's field, the confusing nature of most magnetic interpretations can be appreciated.

(3) To achieve a qualitative understanding of what is occurring, consider Figure 6-2. Within the contiguous United States, the magnetic inclination, that is the angle the main field makes with the surface, varies from 55-70 deg. The figure illustrates the field associated with the main field, the anomalous field induced in a narrow body oriented parallel to that field, and the combined field that will be measured by the total-field magnetometer. The scalar values which would be measured on the surface above the body are listed. From this figure, one can see how the total-field magnetometer records only the components of the anomalous field.

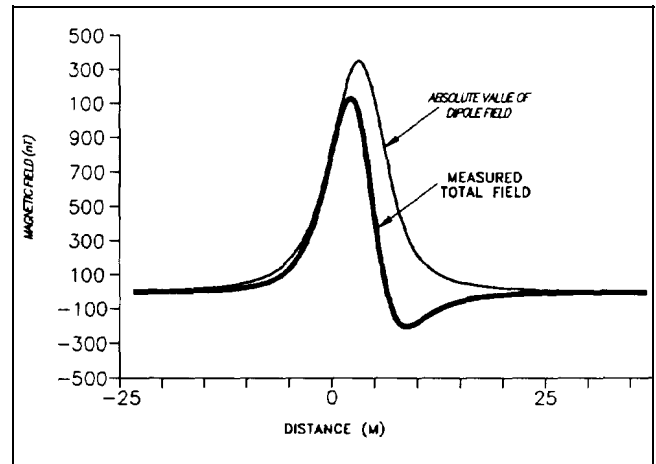

Figure 6-2. Actual and measured fields due to magnetic inclination

## Chapter 7 Subsurface Geophysical Methods

### 7-1. General In-hole Logging Procedures

*a. Introduction.* Borehole geophysics, as defined here, is the science of recording and analyzing measurements in boreholes or wells, for determining physical and chemical properties of soils and rocks. The purpose of this section is to provide the basic information necessary to apply the most useful geophysical well logs for the solution of problems in groundwater, the environmental field, and for engineering applications. Some of the objectives of geophysical well logging are:

- (1) Identification of lithology and stratigraphic correlation.
- (2) Measuring porosity, permeability, bulk density, and elastic properties.
- (3) Characterizing fractures and secondary porosity.
- (4) Determining water quality.
- (5) Identifying contaminant plumes.
- (6) Verifying well construction.

Space limitations prevent a comprehensive discussion of the various logging techniques; references are included for those who need further information on specific techniques (Keys 1990). Although the U.S. Government and some private industry have been converting to the metric system for logging equipment and log measuring units, the inch-pound (IP) system is still standard in the United States. In this manual, the IP system is used where IP is the standard for presently used equipment.

*b. Benefits of logging.* The main objective of borehole geophysics is to obtain more information about the subsurface than can be obtained from drilling, sampling, and testing. Although drilling a test hole or well is an expensive procedure, it provides access to the subsurface where vertical profiles or records of many different kinds of data can be acquired.

(1) Geophysical logs provide continuous analog or digital records of in situ properties of soils and rocks, their contained fluids, and well construction. Logs may be interpreted in terms of: lithology, thickness, and continuity of aquifers and confining beds; permeability,

porosity, bulk density, resistivity, moisture content, and specific yield; and the source, movement, chemical and physical characteristics of groundwater and the integrity of well construction. Log data are repeatable over a long period of time, and comparable, even when measured with different equipment. Repeatability and comparability provide the basis for measuring changes in a groundwater system with time. Changes in an aquifer matrix, such as in porosity by plugging, or changes in water quality, such as in salinity or temperature, may be recorded. Thus, logs may be used to establish baseline-aquifer characteristics to determine how substantial future changes may be or what degradation may have already occurred. Logs that are digitized in the field or later in the office may be corrected rapidly, collated, and analyzed with computers.

(2) Some borehole geophysical tools sample or investigate a volume of rock many times larger than core or cuttings that may have been extracted from the borehole. Some probes record data from rock beyond that disturbed by the drilling process. Samples provide point data from laboratory analysis. In contrast, borehole logs usually are continuous data, and can be analyzed in real time at the well site to guide completion or testing procedures. Unlike descriptive logs written by a driller or geologist, which are limited by their authors' experience and purpose and are highly subjective, geophysical logs may provide information on some characteristic not recognized at the time of geophysical logging. Data from geophysical logs are useful in the development of digital models of aquifers and in the design of groundwater supply, recharge, or disposal systems. A log analyst with the proper background data on the area being studied can provide reasonable estimates of hydraulic properties needed for these purposes. Stratigraphic correlation is a common use of geophysical logs; logs also permit the lateral extrapolation of quantitative data from test or core holes. Using logs, a data point in a well can be extended in three dimensions to increase its value greatly. Many techniques used in surface geophysics are related closely to techniques in borehole geophysics, and the two are considered together when setting up comprehensive groundwater, environmental, or engineering investigations. Geophysical logs, such as acoustic-velocity and resistivity, can provide detailed profiles of data that are useful in interpreting surface surveys, such as seismic and resistivity surveys.

#### *c. Limitations of logging.*

(1) Geophysical logging cannot replace sampling completely, because some information is needed on each new area to aid log analysis. A log analyst cannot

evaluate a suite of logs properly without information on the local geology. Logs do not have a unique response; for example, high gamma radiation from shale is indistinguishable from that produced by granite. To maximize results from logs, at least one core hole should be drilled in each depositional basin or unique aquifer system. If coring the entire interval of interest is too expensive, then intervals for coring and laboratory analysis can be selected on the basis of geophysical logs of a nearby hole. Laboratory analysis of core is essential either for direct calibration of logs or for checking calibration carried out by other means. Calibration of logs carried out in one rock type may not be valid in other rock types because of the effect of chemical composition of the rock matrix.

(2) In spite of the existence of many equations for log interpretation and charts that provide values like porosity, log analysis still is affected by many variables that are not completely understood. Correct interpretation of logs is based on a thorough understanding of the principles of each technique. For this reason, interpretation of logs in the petroleum industry largely is done by professional log analysts. In contrast, very few log analysts are working in the environmental and engineering fields so interpretation of logs for these applications often is carried out by those conducting the investigation.

(3) A thorough understanding of the theory and principles of operation of logging equipment is essential for both logging operators and log analysts. An equipment operator needs to know enough about how each system works to be able to recognize and correct problems in the field and to select the proper equipment configuration for each new logging environment. A log analyst needs to be able to recognize malfunctions on logs and logs that were not run properly. The maximum benefit is usually derived from a logging operation where operators and analysts work together in the truck to select the most effective adjustments for each log.

*d. Cost of logging.* Cost of logging can be reduced significantly by running only those logs that offer the best possibility of providing the answers sought. Further reductions in cost can be achieved by logging only those wells that are properly located and constructed to maximize results from logging. In contrast, more money needs to be spent on log analysis. More time may be required to analyze a suite of logs for maximum return than to run the logs; too often this time is not budgeted when the project is planned.

*e. Planning a logging program.*

(1) A logging program must be properly planned to be of maximum benefit. Borehole geophysics is frequently applied to environmental investigations, such as hydrogeology to aid site selection, monitoring, determining well construction, and planning remediation. In planning a logging program for environmental applications, one of the most difficult questions to answer is what geophysical logs will provide the most information for the funds available. There are several important steps in the decision-making process.

- (a) What are the project objectives?
- (b) What is the hydrogeology of the site?
- (c) How will test holes be drilled and wells constructed?
- (d) Who will do the logging and log analysis?
- (e) What are the financial limitations and how else might some of this data be obtained?

The log selection process needs to start at the time of the initial work plan.

(2) In addition to selecting the general types of logs to be run, many varieties of some logging tools exist (e.g., resistivity, flowmeter, and caliper). The basic information needed to simplify the selection process among the more commonly used logs is provided in Table 7-1 (Keys, Crowder, and Henrich 1993). Decisions on what logs to be run should not be based on this table alone. Table 7-1 should only be used to select logs that should be investigated further. The logs selected should meet specific project objectives, provide the necessary information in the rock units to be drilled, and consider the planned well construction.

*f. Log analysis.*

(1) In recent years, computer techniques have dominated log analysis; however, this development has not changed the basic requirements for getting the most information from logs. First, background information on each new hydrogeologic environment is essential where logs are to be used. The amount and kind of background data needed are functions of the objectives of the program.

Table 7-1  
Log Selection Chart for Geological Applications Using Common Geophysical Logs (Keys, Crowder, and Henrich 1993)

Measurement	ACOUSTIC			ELECTRIC & INDUCTION				FLUID LOGS				RADIOACTIVE OR NUCLEAR			OTHER METHODS				
	Acoustic Televiwer	Acoustic Velocity Δt, CBL, VDL, FWS	Induced Polarization	Multi-electrode Resistivity Normal, Lateral, Micro	Single Point Resistance	Spontaneous Potential	Induction (Conductivity)	Flow Meter	Fluid Resistivity	Fluid Sampler	Temperature, Differential Temp.	Gamma-Gamma Density	Gamma	Neutron	Spectral Gamma	Borehole Video	Caliper	Casing Collar Locator	Deviation
<b>Information Desired</b>	●	●	●	●	●	●	●	●	●	△	△	△	△	△	△	△	△	△	△
<b>Lithology &amp; Correlation</b>	●	●	●	●	●	●	●	●	●	△	△	△	△	△	△	△	△	△	△
<b>Bed/Aquifer thickness; correlation, structure</b>	●	●	●	●	●	●	●	●	●	△	△	△	△	△	△	△	△	△	△
<b>Lithology - Depositional environment</b>	●	●	●	●	●	●	●	●	●	△	△	△	△	△	△	△	△	△	△
<b>Shale or Clay Content</b>	●	●	●	●	●	●	●	●	●	△	△	△	△	△	△	△	△	△	△
<b>Bulk Density</b>	●	●	●	●	●	●	●	●	●	△	△	△	△	△	△	△	△	△	△
<b>Formation Resistivity</b>	●	●	●	●	●	●	●	●	●	△	△	△	△	△	△	△	△	△	△
<b>Injection/Production Profiles</b>	●	●	●	●	●	●	●	●	●	△	△	△	△	△	△	△	△	△	△
<b>Permeability estimates</b>	●	●	●	●	●	●	●	●	●	△	△	△	△	△	△	△	△	△	△
<b>Porosity (amount &amp; type)</b>	●	●	●	●	●	●	●	●	●	△	△	△	△	△	△	△	△	△	△
<b>Mineral Identification</b>	●	●	●	●	●	●	●	●	●	△	△	△	△	△	△	△	△	△	△
<b>Potassium-Uranium-Thorium content (KUT)</b>	●	●	●	●	●	●	●	●	●	△	△	△	△	△	△	△	△	△	△
<b>Strike &amp; Dip of bedding</b>	●	●	●	●	●	●	●	●	●	△	△	△	△	△	△	△	△	△	△
<b>Fracture detection (no. of fractures), ROQ</b>	●	●	●	●	●	●	●	●	●	△	△	△	△	△	△	△	△	△	△
<b>Fracture Orientation &amp; character</b>	●	●	●	●	●	●	●	●	●	△	△	△	△	△	△	△	△	△	△
<b>Thin bed resolution</b>	●	●	●	●	●	●	●	●	●	△	△	△	△	△	△	△	△	△	△
<b>Borehole Fluid characteristics</b>	●	●	●	●	●	●	●	●	●	△	△	△	△	△	△	△	△	△	△
<b>Fluid Flow</b>	●	●	●	●	●	●	●	●	●	△	△	△	△	△	△	△	△	△	△
<b>Formation Water Quality</b>	●	●	●	●	●	●	●	●	●	△	△	△	△	△	△	△	△	△	△
<b>Moisture Content - water Sat.</b>	●	●	●	●	●	●	●	●	●	△	△	△	△	△	△	△	△	△	△
<b>Temperature</b>	●	●	●	●	●	●	●	●	●	△	△	△	△	△	△	△	△	△	△
<b>Water level &amp; water table</b>	●	●	●	●	●	●	●	●	●	△	△	△	△	△	△	△	△	△	△
<b>Casing evaluation</b>	●	●	●	●	●	●	●	●	●	△	△	△	△	△	△	△	△	△	△
<b>Integrity, leaks, damage, Screen location</b>	●	●	●	●	●	●	●	●	●	△	△	△	△	△	△	△	△	△	△
<b>Deviation of borehole</b>	●	●	●	●	●	●	●	●	●	△	△	△	△	△	△	△	△	△	△
<b>Diameter of borehole</b>	●	●	●	●	●	●	●	●	●	△	△	△	△	△	△	△	△	△	△
<b>Examination behind casing</b>	●	●	●	●	●	●	●	●	●	△	△	△	△	△	△	△	△	△	△
<b>Location of debris in wells</b>	●	●	●	●	●	●	●	●	●	△	△	△	△	△	△	△	△	△	△
<b>Well completion evaluation e.g. Cement Bond, Seal location, Grout location</b>	●	●	●	●	●	●	●	●	●	△	△	△	△	△	△	△	△	△	△

**Required Hole Conditions**

- = Cased fluid-filled hole
- = Screened or open fluid-filled hole
- 1 = steel casing only
- \* = Open or non-conductive cased holes, dry or fluid filled
- √ = No restrictions
- ◇ = Clear fluid or dry cased hole
- = Clear fluid or dry open hole
- △ = Active nuclear log to be run in stable holes
- = Open or non-conductive cased holes, dry or fluid filled
- = Open fluid-filled hole only
- ? = Possible applications

Second, the suite of logs to be run should not only be based on project objectives but also on knowledge of the synergistic nature of logs. Two logs may provide answers that may not be possible with either log separately, and each additional log may add much more to a total understanding of the system. Third, logs need to be selected, run, and analyzed on the basis of a thorough understanding of the principles of each log, even if the final results come out of a computer. The process of log analysis can be simplified into several steps, as follows:

(a) Data processing, which includes depth matching, merging all logs and other data from a single well, and editing and smoothing the data set.

(b) Correction of borehole effects and other errors.

(c) Conversion of log measurements to hydrogeologic and engineering parameters of interest, such as porosity.

(d) Combining logs and other data from all wells on a project so the data can be extrapolated laterally in sections or on maps.

(2) Qualitative analysis. Logs were first used for the identification of rock and fluid types, their lateral correlation, and the selection of likely producing intervals for well completion; these uses are still vital today in many fields. Qualitative log analysis is based mostly on knowledge of the local geology and hydrology, rather than on log-response charts or computer plots. Examination of outcrops, core, and cuttings, coupled with an understanding of log response, will permit the identification and correlation of known aquifers and confining beds.

(a) Lithologic interpretation of logs needs to be checked against data from other sources, because geophysical logs do not have a unique response. This requirement is also true of stratigraphic correlation, where gross errors can be made by just "matching the wiggles." Correlation by matching log character can be done without understanding the response to lithology, but this approach can lead to erroneous results. Even within one depositional basin, the response of one type of log may shift from lateral facies changes. For example, the feldspar content of a sandstone may increase toward a granitic source area, which probably would cause an increase in the radioactivity measured by gamma logs. This measurement might be interpreted mistakenly as an increase in clay content unless other logs or data were available. For this reason, the synergism of composite-log interpretation is stressed in this manual. Logs should be interpreted as

an assemblage of data, not singly, to increase the accuracy of analysis.

(b) Accuracy of qualitative interpretation usually improves with an increase in the number of wells that are logged in an area and the amount of available sample data. A gradual change in log response across a depositional basin may indicate a facies change. One anomalous log caused by unusual hole conditions may be identifiable when compared with a number of logs with consistent response; such errors are not likely to repeat. Continuous core or a large number of core samples from one test hole is more useful than a few nonrepresentative samples scattered throughout the section. If continuous coring of one hole cannot be funded, then geophysical logs of a nearby hole can be used to select representative intervals for coring.

(3) Quantitative analysis. Obtaining quantitative data on aquifers or rocks under dam sites is an important objective of many environmental and engineering logging programs; however, the proper steps to ensure reasonable accuracy of the data often are not followed. The scales on logs in physical units, such as percent porosity and bulk density, in grams per cubic centimeter (g/cc), or resistivity, in  $\Omega m$ , must be determined. Even if the procedures described under log calibration and standardization are followed carefully, corroborating data for the particular rocks and wells logged are needed. Repeatability is ensured by logging selected depth intervals a second time; equipment drift is indicated by changes in response as a function of time or temperature. Because of the effect of rock matrix or specific rock type, calibration in one rock type may not ensure accurate parameter scales in another rock type. For this reason, if the rocks being logged are not the same as those in which the equipment was calibrated, core analyses are needed to check values on the logs. Before any log data are used quantitatively, they must be checked for extraneous effects, such as hole diameter or bed thickness.

(a) Data are of questionable value where hole diameter is significantly greater than bit size, or from intervals where bed thickness is equal to, or less than, the vertical dimension of the volume of investigation for the probe. The volume of investigation is defined for the purposes of this manual as that part of the borehole and surrounding rocks that contributes 90 percent of the signal that is recorded as a log. The radius of investigation is the distance from the sensor out to the 90 percent boundary. These terms do not mean that the volume of investigation is spherical or that the boundary is a sharp cutoff. Instead, a gradual decrease in contribution to the signal

occurs with increasing distance from the borehole. The size and shape of the volume of investigation changes in response to varying borehole conditions, the physical properties and geometry of boundaries in the rock matrix and the source to detector spacing. Bed-thickness effects on log response can be best explained using the concept of volume of investigation and its relation to source-to-detector spacing. If a bed is thinner than the vertical dimension of the volume of investigation or thinner than the spacing, the log seldom provides accurate measurement of the thickness or physical properties of that bed because, under these conditions, the volume of investigation includes some of the adjacent beds. From the standpoint of quantitative-log analysis, the best procedure is to eliminate from consideration those depth intervals that demonstrate diameter changes that are significant with respect to the hole diameter response of the logging tool.

(b) Both vertical and horizontal scales on logs need to be selected on the basis of the resolution and accuracy of the data required. Logs obtained by large commercial logging service companies generally have vertical scales of 20 or 50 ft/in., which is not adequate for the detail required in many engineering and environmental studies, where the wells may be only about 100 m deep. Similarly, the horizontal scales on many service-company logs are compressed, to avoid off-scale deflections. Logs digitized in the field will overcome many of these problems and this subject is discussed in detail later. Some logs may be run too fast for the accuracy and thin bed resolution required. When the detector is centered on the contact between two beds of sufficient thickness, half the signal will be derived from one unit, and half from the other; selection of contacts at half amplitude for nuclear logs is based on this fact. If a nuclear or other slow responding log is run too fast, contacts will be hard to pick and will be displaced vertically.

(c) Few logs measure the quantity shown on the horizontal scale directly; for example, the neutron log does not measure porosity; it responds chiefly to hydrogen content. The difference between porosity and hydrogen content can lead to a large porosity error where bound water or hydrocarbons are present. Thus, a knowledge of the principles of log-measuring systems is prerequisite to the accurate quantitative analysis of logs.

(4) Synergistic analysis. Multiple log analysis takes advantage of the synergistic nature of many logs; usually much more can be learned from a suite of logs than from the sum of the logs individually. For example, gypsum cannot be distinguished from anhydrite with either gamma or neutron logs alone, but the two logs together are

diagnostic in areas where gypsum and anhydrite are known to exist. They are both very low in radioactive elements, but gypsum has a significant amount of water of crystallization, so it appears as high porosity on the neutron log. In contrast, anhydrite appears as very low porosity on neutron logs. Both minerals will be logged as high resistivity. Computer analysis of logs can be very helpful in identifying such relationships because shading to emphasize differences between logs is easily accomplished.

(a) Examining a suite of logs from a distance is good practice, so that significant trends and shifts in response become more obvious, in contrast to the detail seen up close. Thus replotting logs at different vertical or horizontal scales, using a computer, may bring out features not previously obvious. The suite of logs needs to be examined for similarities and differences, and explanations need to be sought for log response that departs from that anticipated, based on the available background geologic data. When searching for explanations for anomalous log response, first examine the caliper log to determine if an increase in borehole diameter offers a possible reason. Although many logs are titled borehole-compensated or borehole-corrected, almost all logs are affected to some degree by significant changes in borehole diameter. All drill holes, except those drilled in very hard rocks like granite, have thin intervals where hole diameter exceeds bit size sufficiently to cause anomalous log response. Logs usually can be corrected for average borehole diameter, but thin zones of different diameter spanned by the logging tool are difficult to correct. Drilling technique can have a major effect on variations in borehole diameter.

(b) Well construction information also may explain anomalous response, as may information on the mineral or chemical composition of the rock. Casing, cement, and gravel pack have substantial effects on log character. Some logs are designed specifically to provide information on the location and character of casing and cement. These logs are described in the section on well-completion logging.

(5) Computer analysis. Computer analysis of geophysical well logs is now used widely, and if done properly, can contribute significantly to results from log interpretation. The very large amount of data in a suite of well logs cannot easily be collated or condensed in the human mind so that all interrelations can be isolated and used; computer analysis makes this possible. All of the major commercial well-logging service companies offer digitized logs and computer interpretation. Software

packages for log editing and analysis are available that will run on microcomputers with sufficient memory, data storage, and graphics capability. Although the spreadsheet was not designed for log analysis, someone who understands logs can manipulate the data and plot the results (Keys 1986). They do not, however, offer all of the features and flexibility of a program written specifically for log analysis. Programs written for the analysis of oil well logs have many features not needed for environmental and engineering applications and are often more expensive.

(a) Computer analysis of logs offers a number of advantages over other methods used in the past: a large mass of data can be collated and displayed; logs can be corrected and replotted; scales can be changed; smoothing and filtering operations can be carried out; cross-plots can be made between different kinds of logs, and between logs and core data; calibration curves, correlation functions, and ratios can be plotted, as well as cross-section and isopach maps. Finally, these results can be plotted as publication-quality figures at a cost lower than hand plotting. Although all of these manipulations can be carried out by hand, the large quantity of data present in a suite of logs, or in the logs of all wells penetrating an aquifer system, is ideally suited for computer analysis. Figure 7-1 is a computer-generated cross section of three test holes in the Chicago area. The lithology was entered with key terms capitalized so that a column with lithologic symbols could be automatically generated. The correlation lines were sketched using the program and shading between logs can also be added, as in Figure 7-2.

(b) Changing the vertical and horizontal scales of logs independently was almost impossible before computer processing was available; now replotting to produce scales best suited for the intended purpose is a simple matter. Correcting for nonlinear response or changing from a linear to a logarithmic scale are also relatively simple procedures. Most probes output a pulse frequency or a voltage that is related to the desired parameter by an equation which can easily be solved using a computer. Data from probe calibration can be entered in the computer to produce a log in the appropriate environmental units. For example, most neutron logs are recorded in pulses per second, which can be converted to porosity, if proper calibration and standardization data are available. Other logs that might be computed from raw digital data are: differential temperature, acoustic velocity from transit time, and acoustic reflectivity or acoustic caliper.

(c) A computer is suited ideally for correcting logs and plotting them with calibrated scales. Depth correction

is required on a large number of logs, and it can be carried out at the same time the computer is being used to make the first plot of digitized data. The most common correction needed is a consistent depth shift for the entire log to make it correlate with other logs of the same well or with core data, but stretching of part of a log can also be carried out.

(d) Another important technique for log analysis is the computer plotting of data obtained from logs against data from other logs, core analyses, or tests. The technique most used is the cross plot, which compares the response of two different logs. A cross plot of transit time from the acoustic-velocity log versus porosity from the neutron log, calibrated for limestone, is given in Figure 7-3. Data were plotted from digitized commercial logs of Madison test well No. 1 drilled by the U.S. Geological Survey in Wyoming. The calibration lines labeled sandstone, limestone, and dolomite were obtained from a plot in a book of log-interpretation charts provided by the company that did the logging. These two logs indicate that two major rock types are in the interval plotted: limestone and dolomite. The group of points to the right of the dolomite line indicates secondary porosity in the dolomite. Another kind of cross-plot that can be made using a computer is illustrated in Figure 7-4. The plot shows a third log variable plotted on the Z axis as a function of the neutron log response. This is the same rock sequence shown in Figures 7-1 and 7-2. When the figure is plotted in color or displayed on a color monitor, the bars in the center track are the same color as the areas on the cross plot representing various lithologic units and the neutron log response is shown by colors. The numerical values in the plot represent the neutron log values.

(6) Digitizing logs. Geophysical logs may be digitized at the well while they are being run or subsequently from the analog record. Onsite digitizing is the most accurate and least expensive; with computers now on some logging trucks, real-time processing of the data may be carried out. Onsite digitizing also provides backup for recovery of data that are lost on the analog recorder because of incorrect selection of scales. Off-scale deflections lost from the analog recorder will be available from the digital record. Some systems permit immediate playback of the digital record to the analog recorder with adjustment of both horizontal and vertical scales. Some probes transmit digital information to the surface and others transmit analog data which are digitized at the surface. There are advantages and disadvantages to both systems but regardless of which is used, logs should be digitized while being run. For most logs it is



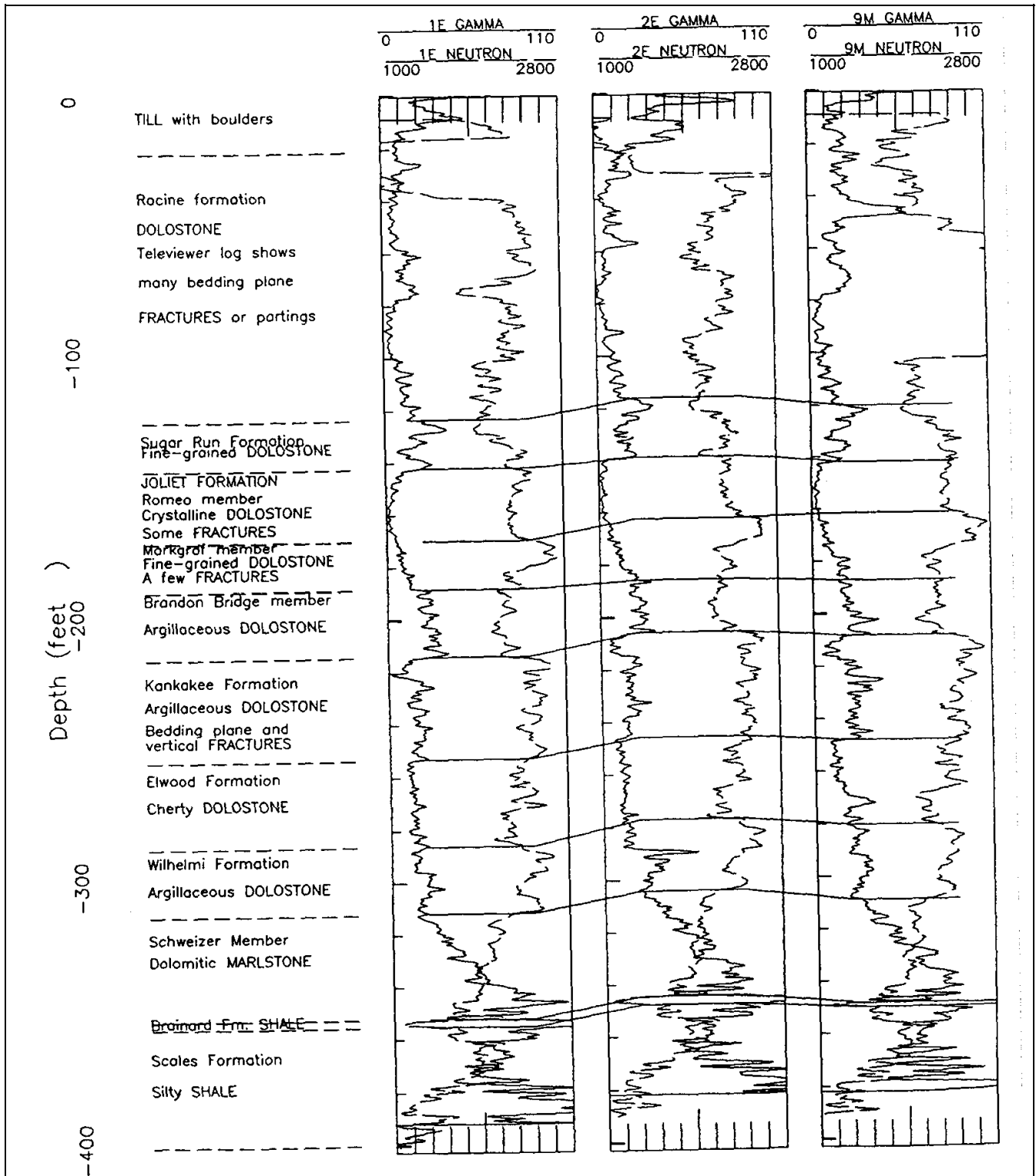

Figure 7-1. Computer plot of gamma and neutron logs of three test holes in the Chicago area, showing stratigraphic correlation based on logs and lithology

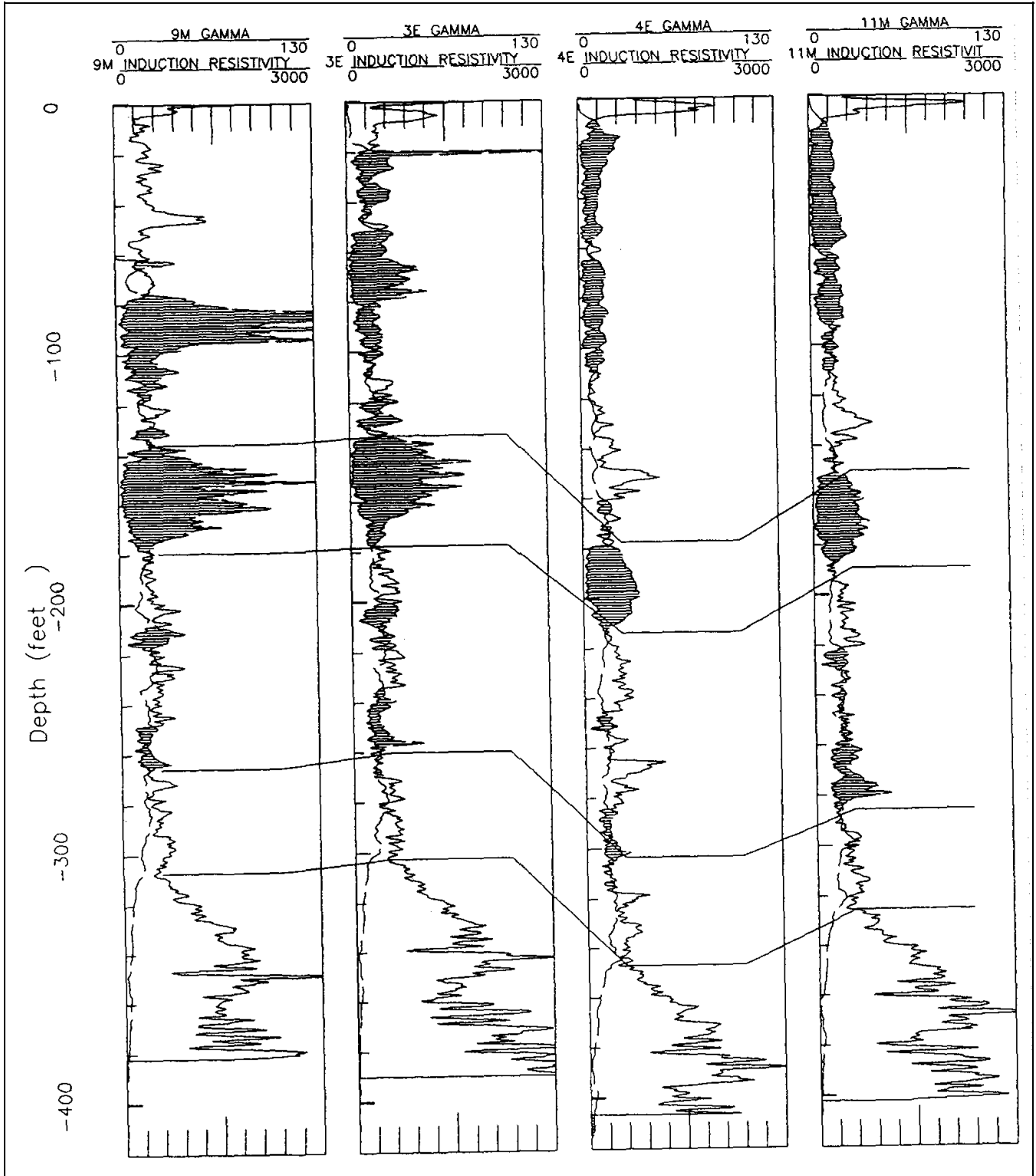

Figure 7-2. Cross section of four test holes in the Chicago area showing correlation enhanced by computer shading between gamma and induction logs

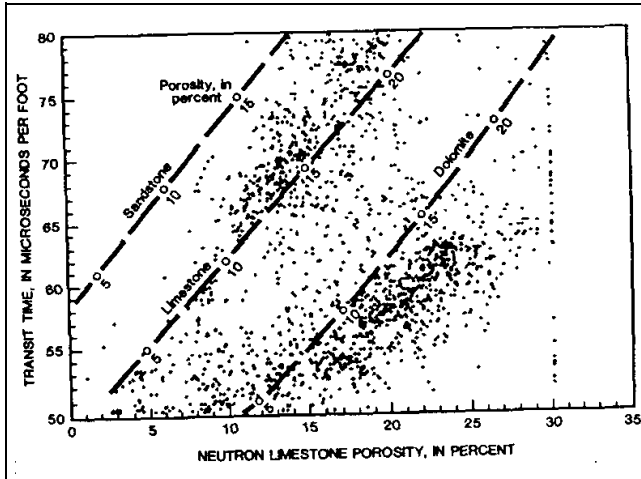

Figure 7-3. Cross plot of acoustic transit times versus neutron porosity, Madison limestone test well No. 1, Wyoming

recommended that the data files be made available immediately to the user in ASCII format because it can be read and reformatted easily by most computers. Some log

data, such as acoustic wave forms and televiewer logs, are digitized in other formats.

(a) Sample interval and sample time need to be correctly selected for onsite digitizing of logs. Sample intervals of 0.15 m are used widely in both the petroleum industry and in groundwater hydrology; however, for detailed engineering and environmental investigations, intervals as small as 0.03 m are often used. If too many samples of the data are recorded, some samples can later be erased, and they can be averaged or smoothed; if not enough samples are recorded, needed information may be lost. Sample time is the duration of time over which a single sample is recorded. Sample time may be milliseconds (ms) or less for analog voltages but may be 1 s or longer for pulse signals from a nuclear-logging probe. Digital data may be printed, plotted, or displayed on a computer monitor while the log is being run. An analog display in real time is needed because watching a log develop is one of the best ways to avoid major errors in logging and to optimize probe and data output configuration.

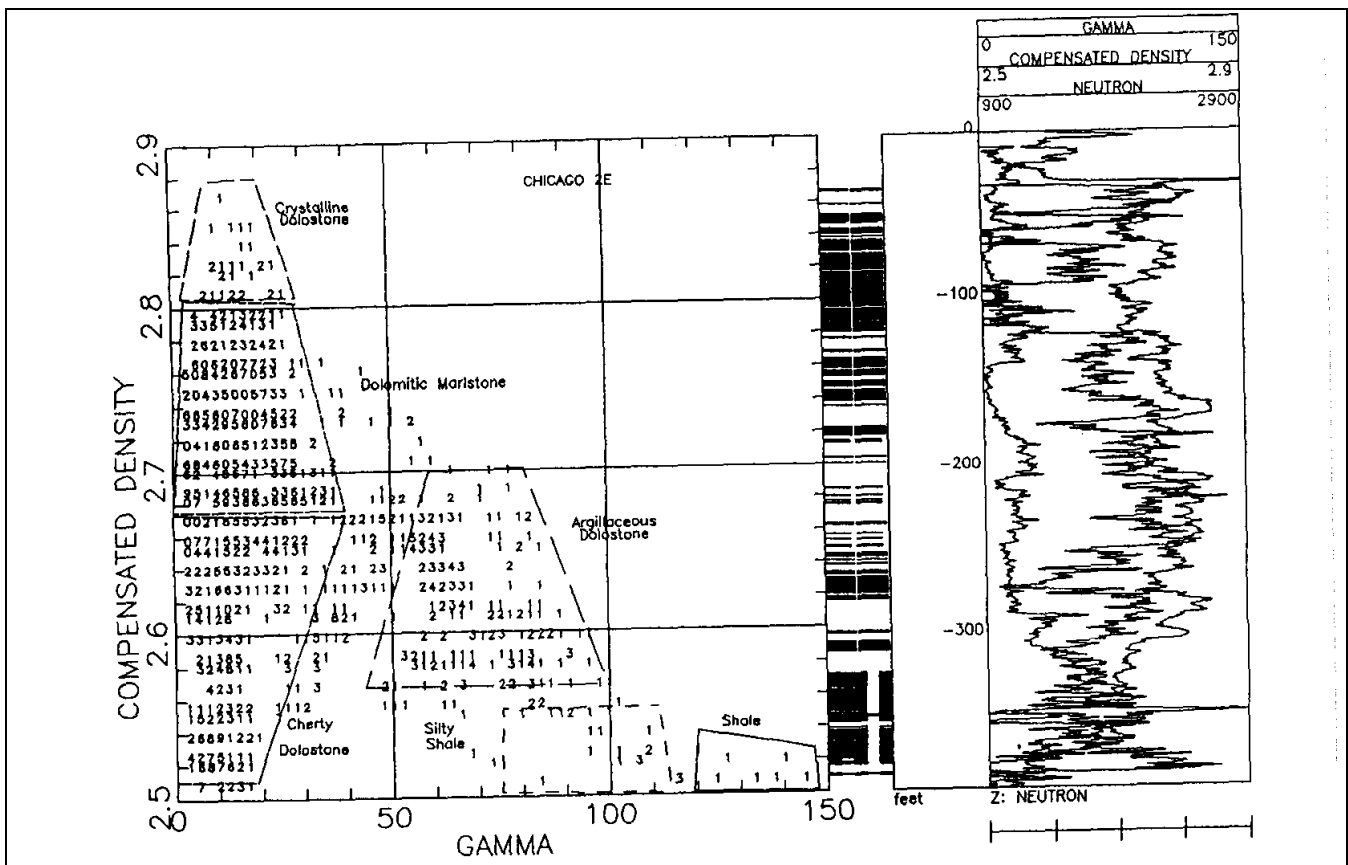

Figure 7-4. Three-dimensional "Z-plot" of gamma, density, and neutron log response of a test hole in the Chicago area

(b) Information on the digital record should be listed on the log heading of the analog plot. This information includes the label on the recording medium, file number, sample interval, time, depth interval recorded, and any calibration information pertinent to the digital record.

(c) Although office digitizing of analog records is expensive and time-consuming, no other choice may exist for old logs. Because of the training needed to digitize logs correctly, particularly multicurve-commercial logs, better and less expensive results usually are obtained from a company specializing in digitizing geophysical logs. To have logs digitized commercially, certain specifications or instructions must be provided to the company with the purchase order. The types of logs to be digitized must be listed, along with the specific curve on each log, the depth interval, the sample interval, and vertical and horizontal scales. If editing of logs is to be done, it must be specified but usually this should be done by the user. In addition to specifying the computer-compatible recording medium, the user can request a printout of all digital data and check plots of the logs. If the check plots are on the same scale as the original, they can be overlaid to verify the accuracy of digitizing.

*g. Borehole effects.*

(1) The manner in which a test hole or well is drilled, completed, and tested has a significant effect on geophysical logs made in that well (Hodges and Teasdale 1991). One of the objectives of logging is to obtain undisturbed values for such rock properties as porosity, bulk density, acoustic velocity, and resistivity, but the drilling process disturbs the rock near the drill hole to varying degrees. Although a number of different types of logging probes are called borehole compensated or borehole corrected, all probes are affected by the borehole to some degree. Borehole effects on geophysical logs can be divided into those produced by the drilling fluids, mud cake, borehole diameter, and well-construction techniques. All these procedures can be controlled to produce better logs, if that is a high-priority objective. In some situations, it may be cost effective to drill two holes close together -- the first designed to optimize logging and the second cored in the depth intervals suggested by those logs. Even if drilling and completion techniques are beyond control, their effect on log response can be reduced by proper probe selection and an understanding of borehole effects.

(2) All drill holes, except those drilled in very hard rocks like granite, have thin intervals where hole diameter exceeds bit size sufficiently to cause anomalous log

response. From the standpoint of quantitative-log analysis, the best procedure is to eliminate from consideration those depth intervals that demonstrate diameter changes that are significant with respect to the hole diameter response of the logging tool.

(3) The difference between a rotary-drilled hole and a nearby core hole in an area where the sedimentary rocks change very little over great distances is shown in Figure 7-5. The core hole was drilled very slowly, with considerable circulation of drilling mud to maximize core recovery. Core recovery was close to 100 percent in these well-cemented mudstones, sandstones, anhydrite, and dolomite. The coring procedure caused significant variations in borehole diameter, partly because of solution

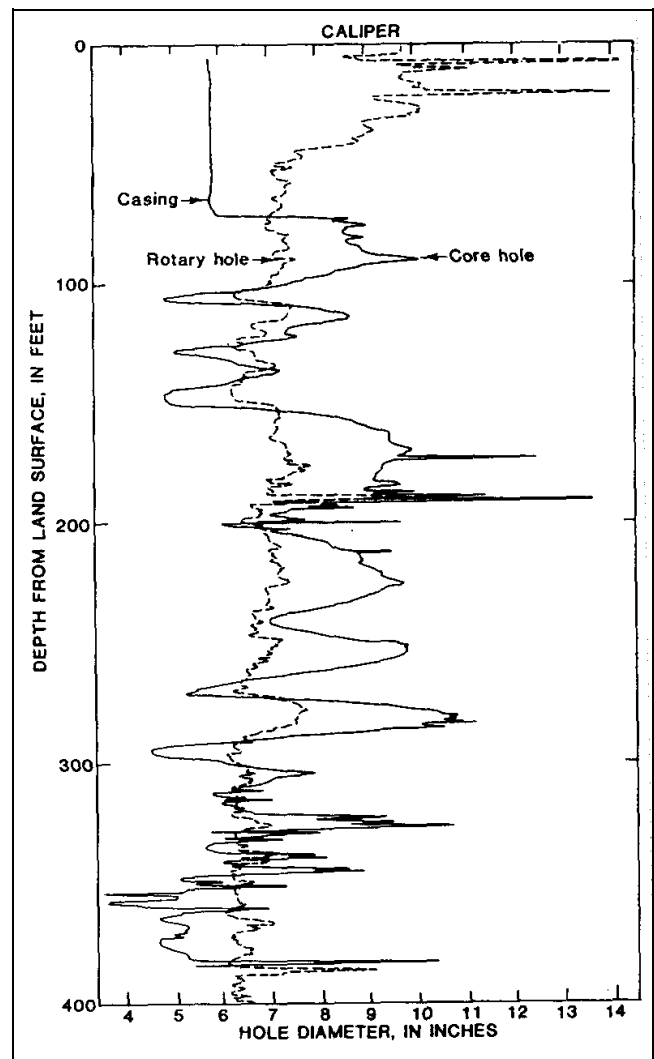

Figure 7-5. Effect of drilling technique on hole diameter. Holes are close together in an area of persistent lithology, Upper Brazos River basin, Texas

of halite cement and veins during the lengthy drilling process, which included numerous trips with the core barrel. The core hole produced some very poor quality logs. The rotary hole was drilled very rapidly to minimize hole-diameter changes. Although increases in hole diameter occurred at the same depths in both holes, the range of diameter was much greater in the core hole. Stratigraphic correlation can be done with caliper logs in this area because hole-diameter changes are closely related to rock type. The very sharp deflections just above 60 m are the result of the solution of halite veins. The very rugose interval below 90 m probably is the result of thin-bedded layers of anhydrite and mudstone.

(4) The hydrostatic pressure of the fluid column is an important factor in preventing caving in poorly consolidated materials. This same pressure can cause invasion of an aquifer by the mud filtrate and the development of a filter cake or mud cake on the wall of the hole. Mud cake may reduce permeability and, thus, change results obtained from various flow-logging devices. The thickness of mud cake often is related to the permeability and porosity of the rocks penetrated. Invasion by drilling fluids may change the conductivity of the pore water and reduce porosity and permeability in the vicinity of the drill hole. Hydraulic fractures can be induced in hard rocks by overpressure during drilling. One technique that is available for determining the extent of alteration of rock and fluid properties adjacent to the borehole is the use of different spacing between source and detector in acoustic or nuclear probes or between electrodes in resistivity probes. Longer spacing usually increases the volume of investigation or increases the percentage of the signal that is derived from material farther from the drill hole. The casing, cement, and gravel pack also have substantial effects on log character. Well completion logs are designed specifically to provide information on the location and character of casing and annular materials.

*h. Operation of logging equipment.* If maximum benefit is to be obtained from an in-house logger that is purchased or rented on a long-term basis, an operator needs to be trained and assigned sole responsibility for the maintenance and repair of that unit. Logging equipment used by a number of people without adequate training and experience will have higher repair costs and more downtime than equipment assigned to one experienced person.

(1) The larger logging service companies are based almost entirely on oil-well operations; smaller companies rely mostly on environmental, engineering, water-wells or mineral exploration holes. Oil-well logging equipment is larger, and, therefore, more expensive, so that the costs

per meter of log are much higher. Oil-well logging probes may be too large for some environmental or engineering test holes, and a large drill rig is needed on the hole to suspend the upper logging sheave. A number of smaller local companies specialize in logging shallower, smaller diameter test holes or wells; some drillers own their own logging equipment. The smaller equipment owned by these companies may not include all the logging techniques available from the commercial service companies. Depth charges, standby time, and mileage costs will be lower for these small companies, but they may not have the calibration facilities common to the larger companies. The low bidder may not provide quality data so proof of ability to perform should be required and a written quality assurance and quality control program should be followed.

(2) The total cost of commercial logging may be difficult for the inexperienced to calculate from price lists, because of the various unit costs involved. Depth and operation charges usually are listed per foot, and a minimum depth is specified. Mileage charges usually prevail over 250 km (150 miles) per round trip. The price of logging on environmental projects may be based on the following:

- (a) Daily service charge.
- (b) Footage charges.
- (c) Mobilization.
- (d) Need for special health and safety measures or training.
- (e) Equipment decontamination.
- (f) Probe and cable loss insurance.
- (g) Crew per diem.
- (h) Any reports, special processing, or data processing required.

The well needs to be ready for logging when the equipment arrives because standby charges are relatively high. The customer is required to sign an agreement before any logging is done, stating that he assumes full responsibility for the cost of any probes that are lost, the cost of all fishing operations for lost probes, and the cost of any damage to the well. If a radioactive source is lost, fishing is required by law, and the well must be cemented up if the source is not recovered. The use of radioactive

sources requires a written agreement which must be addressed in the logging contract.

*i. Log-quality control.*

(1) Control of the quality of geophysical logs recorded at the well site is the responsibility of all concerned, from the organization providing the logs to the analyst interpreting them; the ultimate responsibility lies with the professional who ordered and accepted the logs. No widely accepted standard or guidelines for log quality control exist at present; however, ASTM is presently working on a set of guidelines. Neither private logging companies nor government logging organizations accept responsibility for the accuracy of the data recorded. Agreements signed prior to logging by commercial companies usually include a disclaimer regarding the accuracy of the log data; therefore, the customer needs to assure that the best practices are followed. To obtain the most useful data, the logging program needs to be discussed early in the planning process with a local representative of the organization that will do the logging.

(2) A geoscientist who understands the project objectives and the local geohydrology needs to be in the logging truck during the entire operation. The observer first will specify the order in which the logs will be run. Usually fluid logs will be run first, if the fluid in the well has had time to reach equilibrium. Nuclear logs always will be run last, or through drill stem if necessary, to reduce the possibility of losing a radioactive source. The observer usually makes preliminary interpretations of the logs as they come off the recorder. Based on immediate analysis, reruns can be requested if problems on the logs can be demonstrated. So many factors must be remembered by the observer to help control the quality of logs that many major oil companies provide a quality-control checklist. Log headings that have blanks for a complete set of well and log data also can serve as partial quality-control checklists. Incomplete log headings may prevent quantitative analysis of logs and make qualitative analysis much more difficult. Copies of digital data and field prints of all logs, including repeat runs, and field calibration or standardization should be left with the project manager before the logging equipment leaves the site. This data should be checked by a qualified person to determine if it is complete and without obvious problems before the logging equipment leaves.

(3) Log headings may be divided into two basic sections: information on the well and data pertaining to the logging equipment and operations. The completed heading needs to be attached to the analog record in the

field. A short reference to the log-heading information entered on the digital recording of each log enables the two records to be related. This reference will include the following information, as a minimum: hole number, date, log type, run number. The format of a log heading is not important; the information is essential.

(4) The well-information section of the heading must contain all of the following, if available:

- (a) Well name and number.
- (b) Location - township, range, section, distance from nearest town, etc.
- (c) Owner.
- (d) Driller, when drilled, drilling technique, and drilled depth.
- (e) Elevation of land surface.
- (f) Height of casing above land surface.
- (g) Depth reference.
- (h) Complete description of all casing, type, size, and depth intervals.
- (i) Location of cement, bentonite, perforations, and screens.
- (j) Drilled size(s) (or bit size) and depth intervals.
- (k) Fluid type, level, resistivity, and temperature.

(5) The log information section of a heading will contain different information for each type of log, although the same heading can be used for similar logs. The following information is needed on the heading for each log:

- (a) Type of log, run (\_\_\_ of \_\_\_), date.
- (b) Number or description of logging truck.
- (c) Logging operator(s), observers.
- (d) Probe number and description -- including diameter, type, detector(s), spacing, centralized or decentralized, source type and size, etc.
- (e) Logging speed.

(f) Logging scales - vertical (depth) and horizontal, including all changes and depths at which they were made.

(g) Recorder scales - millivolts (span) and positioning.

(h) Module or panel settings - scale, span, position, time constant, discrimination.

(i) Power supply - voltage, current.

(j) Calibration and standardization data - pre- and post-log digital values recorded on heading and analog positions on logs.

(6) List all other logs of the well run on the same date. Also briefly describe all problems or any unusual response during logging; mark at the appropriate depth on the log.

*j. Calibration and standardization of logs.*

(1) Logs need to be properly calibrated and standardized, if logs are to be used for any type of quantitative analysis or used to measure changes in a groundwater system with time. *Calibration* is considered to be the process of establishing environmental values for log response in a semi-infinite model that closely simulates natural conditions. Environmental units are related to the physical properties of the rock, such as porosity or acoustic velocity. Probe output may be recorded in units, such as pulses per second, that can be converted to environmental units with calibration data. Calibration pits or models are maintained by the larger commercial service companies; these are not readily available for use by other groups. The American Petroleum Institute maintains a limestone-calibration pit for neutron probes and a simulated shale pit for calibrating gamma probes, and a pit for calibrating gamma spectral probes at the University of Houston; these have been accepted internationally as the standards for oil-well logging. Boreholes that have been carefully cored, where the cores have been analyzed quantitatively, also may be used to calibrate logging probes. To reduce depth errors, core recovery in calibration holes needs to approach 100 percent for the intervals cored, and log response can be used to elect samples for laboratory analyses. Because of the possibility of depth errors in both core and logs, and of bed-thickness errors, samples need to be selected in thicker units, where log response does not vary much. It is advisable to have a well for periodic logging to determine if log response is consistent. A core hole is excellent for this purpose.

(2) *Standardization* is the process of checking response of the logging probes in the field, usually before and after logging. Standardization uses some type of a portable field standard that usually is not infinite and may not simulate environmental conditions. Frequent standardization of probes provides the basis for correcting for system drift in output with time and for recognizing other equipment problems. The frequency of log standardization should be related to project objectives - if accurate data are needed, standardization should be more frequent.

*k. Logging techniques/tools.*

(1) Spontaneous potential logging.

(a) Principles. Spontaneous potential (SP) is one of the oldest logging techniques. It employs very simple equipment to produce a log whose interpretation may be quite complex, particularly in freshwater aquifers. This complexity has led to misuse and misinterpretation of spontaneous potential (SP) logs for groundwater applications. The spontaneous potential log (incorrectly called self potential) is a record of potentials or voltages that develop at the contacts between shale or clay beds and a sand aquifer, where they are penetrated by a drill hole. The natural flow of current and the SP curve or log that would be produced under the salinity conditions given are shown in Figure 7-6. The SP measuring equipment consists of a lead or stainless steel electrode in the well connected through a millivolt meter or comparably sensitive recorder channel to a second electrode that is grounded at the surface (Figure 7-7). The SP electrode usually is incorporated in a probe that makes other types of electric logs simultaneously so it is usually recorded at no

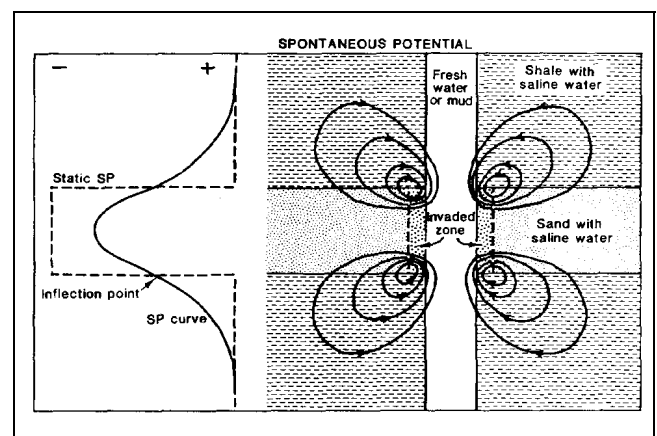

**Figure 7-6. Flow of current at typical bed contacts and the resulting spontaneous-potential curve and static values**

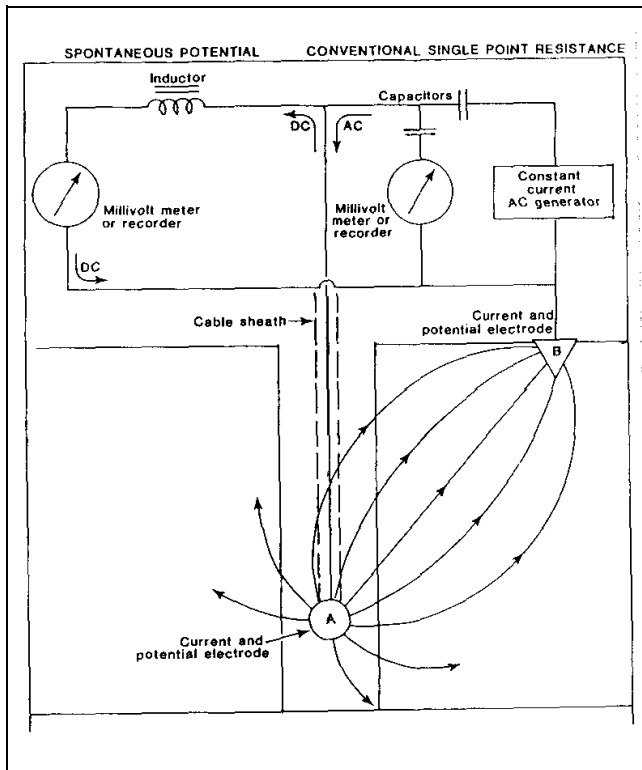

**Figure 7-7. System used to make conventional single-point resistance and spontaneous-potential logs**

additional cost. Spontaneous potential is a function of the chemical activities of fluids in the borehole and adjacent rocks, the temperature, and the type and amount of clay present; it is not directly related to porosity and permeability. The chief sources of spontaneous potential in a drill hole are electrochemical, electrokinetic, or streaming potentials and redox effects. When the fluid column is fresher than the formation water, current flow and the SP log are as illustrated in Figure 7-6; if the fluid column is more saline than water in the aquifer, current flow and the log will be reversed. Streaming potentials are caused by the movement of an electrolyte through permeable media. In water wells, streaming potential may be significant at depth intervals where water is moving in or out of the hole. These permeable intervals frequently are indicated by rapid oscillations on an otherwise smooth curve. Spontaneous potential logs are recorded in millivolts per unit of chart paper or full scale on the recorder. Any type of accurate millivolt source may be connected across the SP electrodes to provide calibration or standardization at the well. The volume of investigation of an SP sonde is highly variable, because it depends on the resistivity and cross-sectional area of beds intersected by the borehole. Spontaneous potential logs are more affected by stray electrical currents and equipment problems than most

other logs. These extraneous effects produce both noise and anomalous deflections on the logs. An increase in borehole diameter or depth of invasion decreases the magnitude of the SP recorded. Obviously, changes in depth of invasion with time will cause changes in periodic SP logs. Because the SP is largely a function of the relation between the salinity of the borehole fluid and the formation water, any changes in either will cause the log to change.

(b) Interpretation and applications. Spontaneous potential logs have been used widely in the petroleum industry for determining lithology, bed thickness, and the salinity of formation water. SP is one of the oldest types of logs, and is still a standard curve included in the left track of most electric logs. The chief limitation that has reduced the application of SP logs to groundwater studies has been the wide range of response characteristics in freshwater environments. As shown in Figure 7-6, if the borehole fluid is fresher than the native interstitial water, a negative SP occurs opposite sand beds; this is the so-called standard response typically found in oil wells. If the salinities are reversed, then the SP response also will be reversed, which will produce a positive SP opposite sand beds. Thus, the range of response possibilities is very large and includes zero SP (straight line), when the salinity of the borehole and interstitial fluids are the same. Lithologic contacts are located on SP logs at the point of curve inflection, where current density is maximum. When the response is typical, a line can be drawn through the positive SP-curve values recorded in shale beds, and a parallel line may be drawn through negative values that represent intervals of clean sand. A typical response of an SP log in a shallow-water well, where the drilling mud was fresher than the water in the aquifers, is shown in Figure 7-8. The maximum positive SP deflections represent intervals of fine-grained material, mostly clay and silt; the maximum negative SP deflections represent coarser sediments. The gradational change from silty clay to fine sand near the bottom of the well is shown by a gradual change on the SP log. The similarity in the character of an SP log and a gamma log under the right salinity conditions also is shown in this figure. Under these conditions, the two types of logs can be used interchangeably for stratigraphic correlation between wells where either the gamma or the SP might not be available in some wells. The similarity between SP and gamma logs also can be used to identify wells where salinity relationships are different from those shown in Figure 7-8. Spontaneous-potential logs have been used widely for determining formation-water resistivity ( $R_w$ ) in oil wells, but this application is limited in fresh groundwater



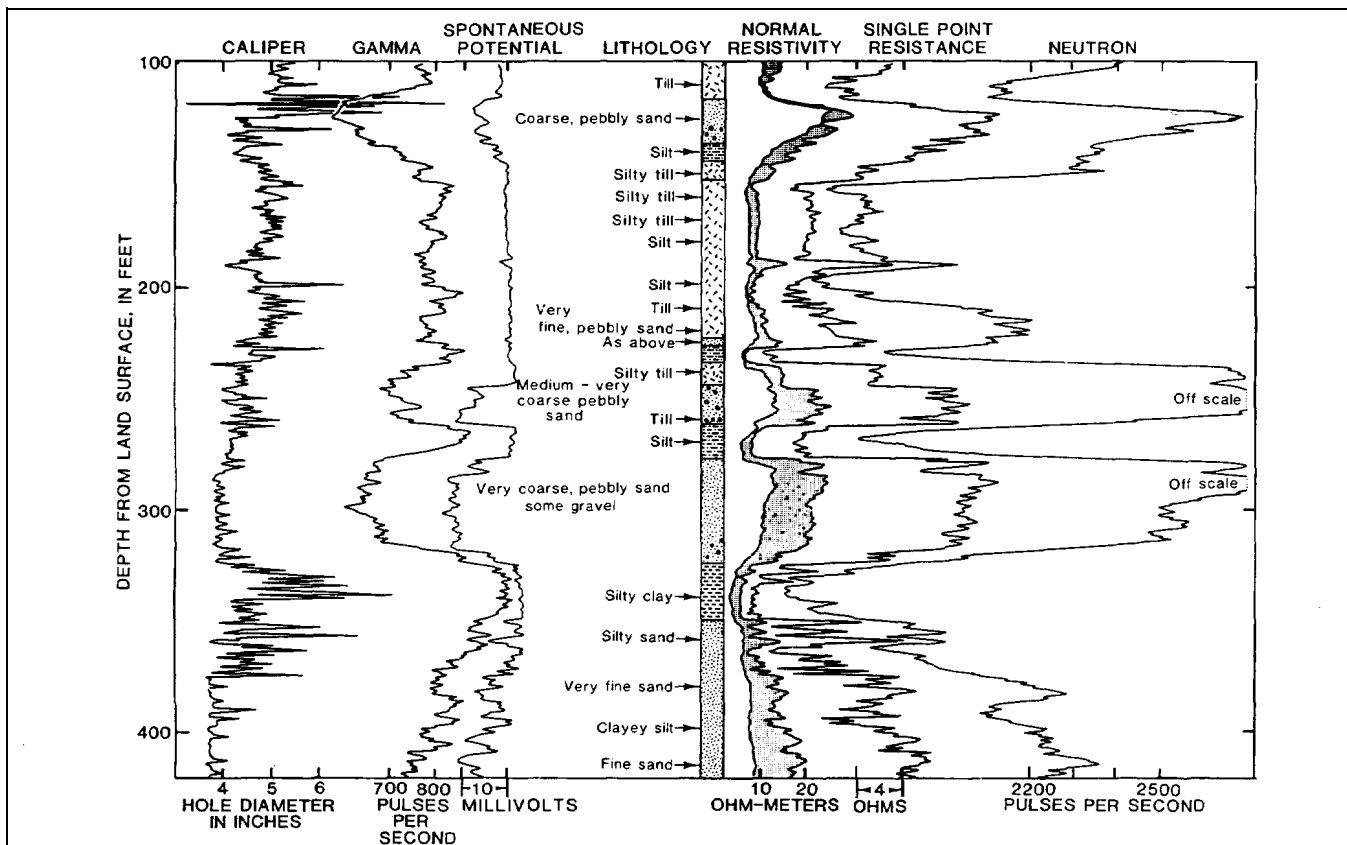

Figure 7-8. Caliper, gamma, spontaneous-potential, normal-resistivity, single-point resistance, and neutron logs compared to lithology; Kipling, Saskatchewan, Canada

systems. In sodium chloride type saline water, the following relation is used to calculate  $R_w$ :

$$SP = -K \log (R_m/R_w) \quad (7-1)$$

where

$SP$  = log deflection, in  $mV$

$$K = 60 + 0.133T$$

$T$  = borehole temperature, in degrees Fahrenheit (metric and IP units are mixed for equation validity)

$R_m$  = resistivity of borehole fluid, in  $\Omega m$

$R_w$  = resistivity of formation water, in  $\Omega m$

The SP deflection is read from a log at a thick sand bed;  $R_m$  is measured with a mud-cell or fluid-conductivity log. Temperature may be obtained from a log, but it also can

be estimated, particularly if bottom-hole temperature is available. The unreliability of determining  $R_w$  of fresh water using the SP equation has been discussed by Patten and Bennett (1963) and Guyod (1966). Several conditions must be met if the equation is to be used for groundwater investigations. These conditions are not satisfied in most freshwater wells. The conditions are as follows: Both borehole fluids and formation water need to be sodium chloride solutions. The borehole fluid needs to be quite fresh, with a much higher resistivity than the combined resistivity of the sand and shale; this requirement usually means that the formation or interstitial water must be quite saline. The shales need to be ideal ion-selective membranes, and the sands need to be relatively free of clay. No contribution can be made to the SP from such sources as streaming potential.

(2) Single-point resistance logging.

(a) Principles. The single-point resistance log has been one of the most widely used in non-petroleum logging in the past; it is still useful, in spite of the increased

application of more sophisticated techniques. Single-point logs cannot be used for quantitative interpretation, but they are excellent for lithologic information. The equipment to make single-point logs usually is available on most small water-well loggers, but it is almost never available on the larger units used for oil-well logging. The resistance of any medium depends not only on its composition, but also on the cross-sectional area and length of the path through that medium. Single-point resistance systems measure the resistance, in  $\Omega$ , between an electrode in the well and an electrode at the surface or between two electrodes in the well. Because no provision exists for determining the length or cross-sectional area of the travel path of the current, the measurement is not an intrinsic characteristic of the material between the electrodes. Therefore, single-point resistance logs cannot be related quantitatively to porosity, or to the salinity of water in those pore spaces, even though these two parameters do control the flow of electric current. A schematic diagram of the equipment used to make conventional single-point resistance and spontaneous potential logs is shown in Figure 7-7. The two curves can be recorded simultaneously if a two-channel recorder is available. The same ground and down-hole electrodes (A and B) are used for both logs. Each electrode serves as a current and as a potential sensing electrode for single-point logs. The single-point equipment on the right side of the figure actually measures a potential in volts (V) or *mV* which can be converted to resistance by use of Ohm's law, because a constant current is maintained in the system. For the best single-point logs, the electrode in the well needs to have a relatively large diameter, with respect to the hole diameter, because the radius of investigation is a function of electrode diameter. The differential system, with both current and potential electrodes in the probe, which are separated by a thin insulating section, provides much higher resolution logs than the conventional system but is not available on many loggers. Scales on single-point resistance logs are calibrated in  $\Omega$  per inch of span on the recorder. The volume of investigation of single-point resistance sonde is small, approximately 5 to 10 times the electrode diameter. Single-point logs are greatly affected by changes in well diameter, partly because of the relatively small volume of investigation.

(b) Interpretation and applications. Single-point resistance logs are useful for obtaining information on lithology; the interpretation is straightforward, with the exception of the extraneous effects described previously. Single-point logs have a significant advantage over multi-electrode logs; they do not exhibit reversals as a result of bed-thickness effects. Single-point logs deflect in the proper direction in response to the resistivity of materials

adjacent to the electrode, regardless of bed thickness; thus, they have a very high vertical resolution. The response of both differential and conventional single-point logs to fractures is illustrated in Figure 7-9. In this figure, at least one of the logging systems was not properly calibrated, because the scales differ by an order of magnitude. Hole enlargements shown on the caliper log are almost entirely caused by fractures in the crystalline rocks penetrated by this hole. The differential single-point log defines the fractures with much greater resolution than the log made with the conventional system.

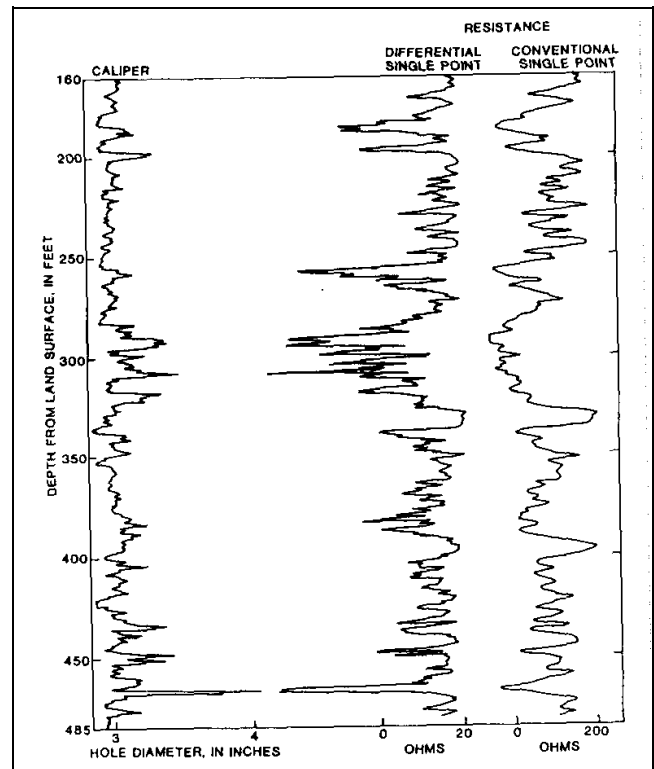

Figure 7-9. Caliper, differential, and conventional single-point resistance logs in a well in fractured crystalline rocks

(3) Normal-resistivity logging.

(a) Principles. Among the various multi-electrode resistivity-logging techniques, normal resistivity is probably the most widely used in groundwater hydrology, even though the long normal log has become rather obsolete in the oil industry. Normal-resistivity logs can be interpreted quantitatively when they are properly calibrated in terms of  $\Omega m$ . Log measurements are converted to apparent resistivity, which may need to be corrected for mud resistivity, bed thickness, borehole diameter, mudcake, and invasion, to arrive at true resistivity. Charts for making

these corrections are available in old logging manuals. Figure 7-10 is an example of one of these charts that is used to correct 16-in. normal curves for borehole diameter and mud resistivity. The arrows on this chart show examples of corrections for borehole size and mud resistivity ( $R_m$ ). If the resistivity from a 16-in. normal curve divided by the mud resistivity is 50 in a 10-in. borehole, the ratio will be 60 in an 8-in. borehole. If the apparent resistivity on a 16-in. normal log is 60  $\Omega m$  and the  $R_m$  is 0.5  $\Omega m$  in a 9-in. well, the ratio on the X-axis is 195. The corrected log value is 97.5  $\Omega m$  at formation temperature. Temperature corrections and conversion to conductivity and to equivalent sodium chloride concentrations can be made using Figure 7-11. To make corrections, the user should follow along isosalinity lines because only resistivity, or its inverse, conductivity, changes as a function of temperature, not ionic concentrations.

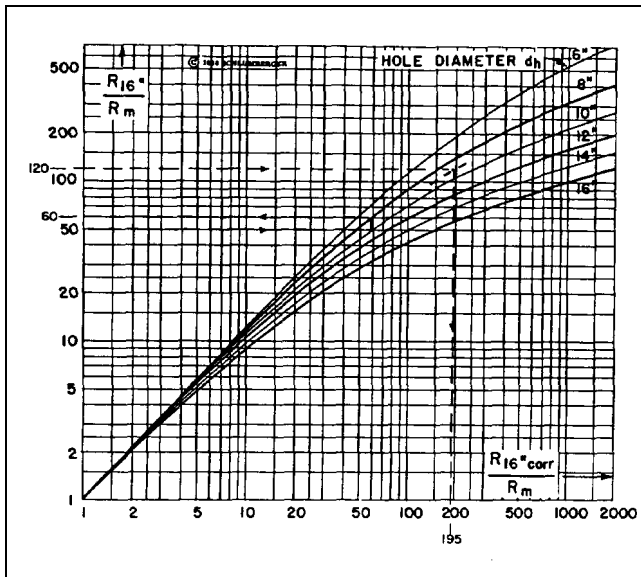

Figure 7-10. Borehole correction chart for 16-in. normal resistivity log (copyright permission granted by Schlumberger)

(b) Definition. By definition, resistivity is a function of the dimensions of the material being measured; therefore, it is an intrinsic property of that material. Resistivity is defined by the formula:

$$R = rS/L = (\Omega \times m \times m/m) = (\Omega \times m) = (\Omega m) \quad (7-2)$$

where

$$R = \text{resistivity, in } \Omega m$$

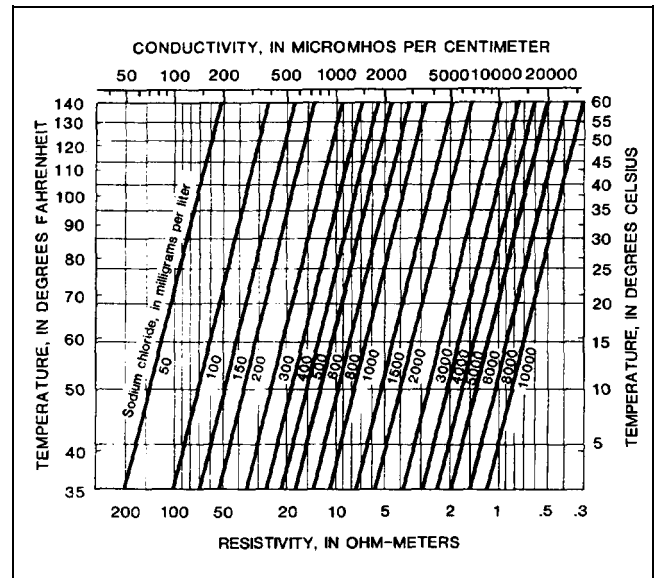

Figure 7-11. Electrically equivalent sodium chloride solution plotted as a function of conductivity or resistivity and temperature

$r$  = resistance, in  $\Omega$

$S$  = cross section, in square meters

$L$  = length, in m

The principles of measuring resistivity are illustrated in Figure 7-12. If 1 amp of current from a 10-V battery is passed through a 1-m<sup>3</sup> block of material, and the drop in potential is 10 V, the resistivity of that material is 10  $\Omega m$ . The current is passed between electrodes A and B, and the voltage drop is measured between potential electrodes M and N, which, in the example, are located 0.1 m apart so that 1 V is measured rather than 10 V. The current is maintained constant, so that the higher the resistivity between M and N, the greater the voltage drop will be. A commutated DC current is used to avoid polarization of the electrodes that would be caused by the use of direct current.

(c) AM spacing. For normal-resistivity logging, electrodes A and M are located in the well relatively close together, and electrodes B and N are distant from AM and from each other, as shown in Figure 7-13. Electrode configuration may vary in equipment produced by different manufacturers. The electrode spacing, from which the normal curves derive their name, is the distance between A and M, and the depth reference is at the midpoint of this distance. The most common AM spacings are 16 and

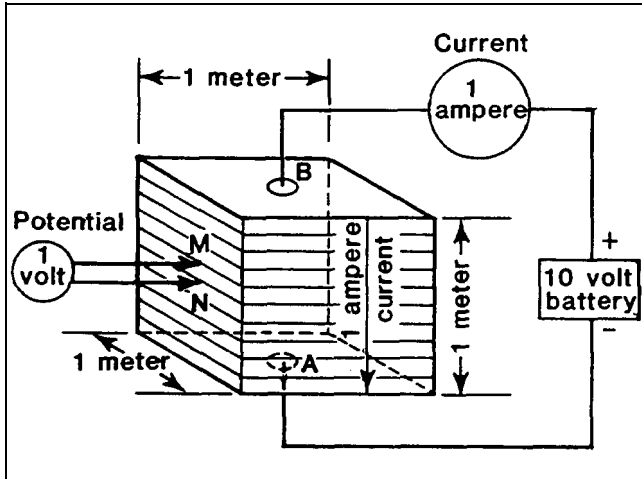

Figure 7-12. Principles of measuring resistivity in  $\Omega\text{m}$ . Example is  $10 \Omega\text{m}$

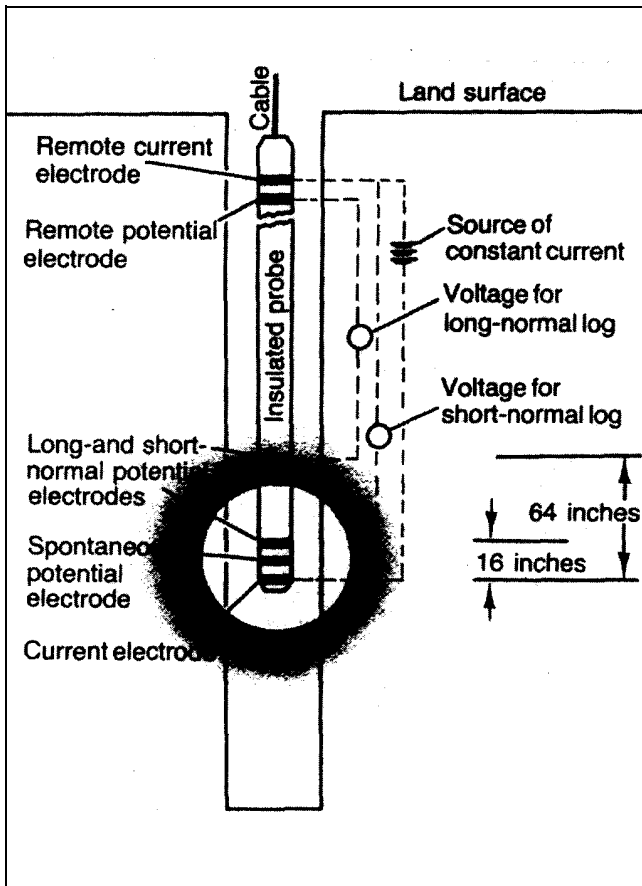

Figure 7-13. System used to make 16- and 64-in. normal-resistivity logs. Shaded areas indicate relative size of volumes of investigation

64 in.; however, some loggers have other spacings available, such as 4, 8, 16, and 32 in. The distance to the B electrode, which is usually on the cable, is approximately 15 m; it is separated from the AM pair by an insulated section of cable. The N electrode usually is located at the surface, but in some equipment, the locations of the B and N electrodes may be reversed. Constant current is maintained between an electrode at the bottom of the sonde and a remote-current electrode. The voltage for the long normal (64-in.) and the short normal (16-in.) is measured between a potential electrode for each, located on the sonde, and a remote potential electrode. The SP electrode is located between the short normal electrodes. The relative difference between the volumes of material investigated by the two normal systems also is illustrated in Figure 7-13. The volume of investigation of the normal resistivity devices is considered to be a sphere, with a radius approximately twice the AM spacing. This volume changes as a function of the resistivity, so that its size and shape are changing as the well is being logged.

(d) Depth of invasion. Although the depth of invasion is a factor, short normal (16 in. or less) devices are considered to investigate only the invaded zone, and long normal (64-in.) devices are considered to investigate both the invaded zone and the zone where native formation water is found. These phenomena are illustrated in Figure 7-8. In this figure, the area between a 32-in. curve on the left and a 4-in. curve on the right is shaded. The longer spaced curve indicates a lower resistivity farther back in the aquifers than in the invaded zone near the borehole wall, which suggests that the formation water is relatively saline with respect to the borehole fluid.

(e) Calibration. Normal-resistivity logging systems may be calibrated at the surface by placing fixed resistors between the electrodes. The formula used to calculate the resistor values to be substituted in the calibration network shown in Figure 7-14 is given in Keys (1990).

(f) Interpretation. Long normal response is affected significantly by bed thickness; this problem can make the logs quite difficult to interpret. The bed-thickness effect is a function of electrode spacing, as illustrated in Figure 7-15. The theoretical resistivity curve (solid line) and the actual log (dashed line) for a resistive bed, with a thickness six times the AM spacing, is shown in the top part of the figure. Resistivity of the limestone is assumed to be six times that of the shale, which is of infinite

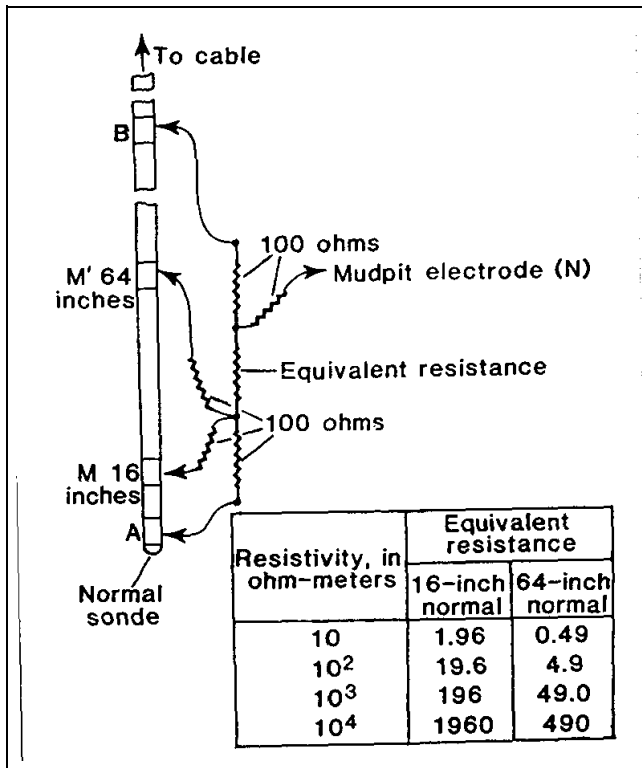

Figure 7-14. System for calibrating normal-resistivity equipment

thickness. With a bed thickness six times AM, the recorded resistivity approaches, but does not reach, the true resistivity ( $R_t$ ); the bed is logged as being one AM spacing thinner than it actually is. The actual logged curve is a rounded version of the theoretical curve, in part because of the effects of the borehole. The log response when the bed thickness is equal to or less than the AM spacing is illustrated in the lower half of Figure 7-15. The curve reverses, and the high-resistivity bed actually appears to have a lower value than the surrounding material. The log does not indicate the correct bed thickness, and high-resistivity anomalies occur both above and below the limestone. Although increasing the spacing to achieve a greater volume of investigation would be desirable, bed-thickness effects would reduce the usefulness of the logs except in very thick lithologic units.

(g) Applications. An important application of normal resistivity logs and other multi-electrode logs is for determining water quality. Normal logs measure apparent resistivity; if true resistivity is to be obtained from these logs they must be corrected with the appropriate charts or departure curves. A summary of these techniques is found in "The Art of Ancient Log Analysis," compiled

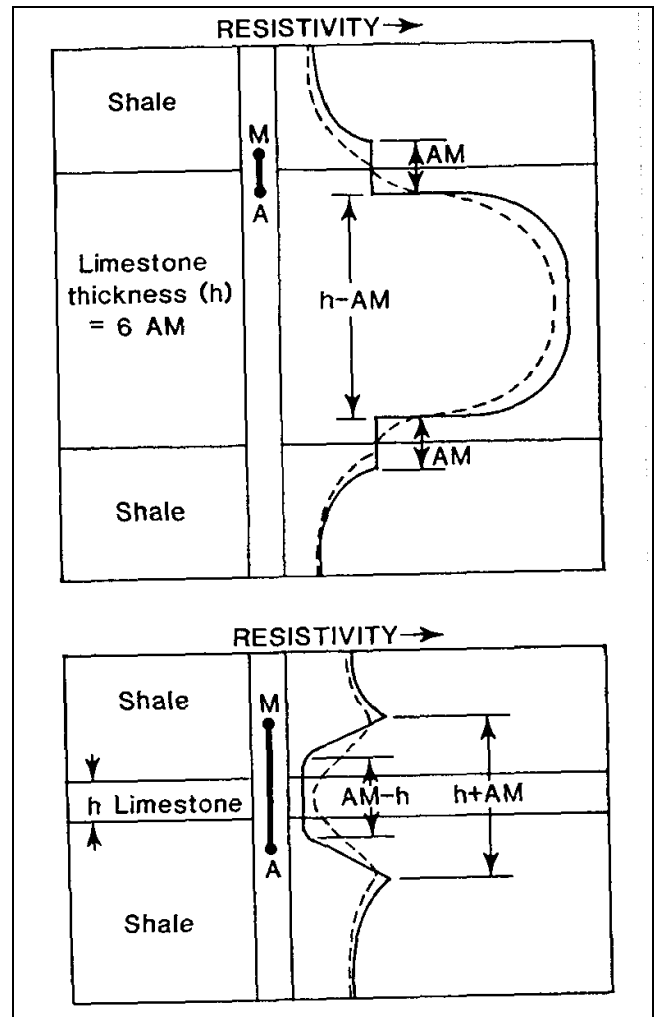

Figure 7-15. Relation of bed thickness to electrode spacing for normal devices at two thicknesses

by the Society of Professional Well Log Analysts (1979). A practical method is based on establishing field-formation resistivity factors ( $F$ ) for aquifers within a limited area, using electric logs and water analyses. After a consistent formation factor is established, the long normal curve, or any other resistivity log that provides a reasonably correct  $R_t$  can be used to calculate  $R_w$  from the relationship:  $F = R_o/R_w$ . Under these conditions  $R_o$  the resistivity of a rock 100 percent saturated with water, is assumed to approximate  $R_p$ , after the appropriate corrections have been made. Resistivities from logs can be converted to standard temperature using Figure 7-11, and the factors listed in Keys (1990) can be used to convert water containing other ions to the electrically equivalent sodium chloride solution. The formation resistivity factor ( $F$ ) also defines the relation between porosity ( $\phi$ ) and

resistivity as follows:  $F = a/\phi^m = R_o/R_w$ , where  $m$  is the cementation exponent (Archie's formula). See Jorgensen (1989) for a more complete description of these relations. Using porosity derived from a neutron, gamma-gamma, or acoustic velocity log and  $R_o$  from a deep investigating resistivity log, one can determine the resistivity of the formation water in granular sediments. The relation between resistivity from normal logs and the concentration of dissolved solids in groundwater is only valid if the porosity and clay content are relatively uniform. The method does not apply to rocks with a high clay content or with randomly distributed solution openings or fractures. Surface conduction in clay also tends to reduce the resistivity measured. The resistivity logs in Figure 7-8 were used to calculate the quality of the water in aquifers at the Kipling well site in Saskatchewan, Canada. The left trace of the two normal resistivity logs shown is the 32-in. normal, which was used to calculate  $R_w$  for three of the shallower aquifers intersected. These aquifers are described as coarse pebbly sand based on side-wall core samples. The 32-in. normal was selected because many of the beds in this area are too thin for longer spacing. Wyllie (1963) describes a method for estimating  $F$  from the ratio  $R_i/R_m$ ; where  $R_i$  is the resistivity of the invaded zone from a short normal log like the 4-in.; and  $R_m$  is the measured resistivity of the drilling mud. On the basis of the 4-in. curve,  $F$  was estimated to be 2.5 for the upper aquifer and 1.8 for the lower two. The true resistivities for the three aquifers obtained from departure curves are 30, 20, and 17  $\Omega m$  at depths of 130, 250, and 295 ft, respectively. A formation factor of 3.2 provided good agreement with water quality calculated from SP logs and from laboratory analyses. Using an  $F$  of 3.2,  $R_w$  was calculated to be 9.4, 6.2, and 5.3  $\Omega m$  at 4°C for the three aquifers. The drilling mud measured 13  $\Omega m$  at borehole temperature. The separation of the two normal curves and the SP log response substantiated the fact that the water in the aquifers was more saline than the drilling mud.

(4) Lateral resistivity logging. Lateral logs are made with four electrodes like the normal logs but with a different configuration of the electrodes. The potential electrodes M and N are located 0.8  $m$  apart; the current electrode A is located 5.7  $m$  above the center ( $O$ ) of the MN spacing in the most common petroleum tool, and 1.8  $m$  in tools used in groundwater. Lateral logs are designed to measure resistivity beyond the invaded zone, which is achieved by using a long electrode spacing. They have several limitations that have restricted their use in environmental and engineering applications. Best results are obtained when bed thickness is greater than twice AO, or more than 12  $m$  for the standard spacing.

Although correction charts are available, the logs are difficult to interpret. Anomalies are asymmetrical about a bed, and the amount of distortion is related to bed thickness and the effect of adjacent beds. For these reasons the lateral log is not recommended for most engineering and environmental applications.

(5) Focused-resistivity logging.

(a) Focused-resistivity systems were designed to measure the resistivity of thin beds or high-resistivity rocks in wells containing highly conductive fluids. A number of different types of focused-resistivity systems are used commercially; the names "guard" or "laterolog" are applied to two of these. Focused or guard logs can provide high resolution and great penetration under conditions where other resistivity systems may fail. Focused-resistivity devices use guard electrodes above and below the current electrode to force the current to flow out into the rocks surrounding the well. The depth of investigation is considered to be about three times the length of one guard, so a 6-ft guard should investigate material as far as 5.5  $m$  from the borehole. The sheetlike current pattern of the focused devices increases the resolution and decreases the effect of adjacent beds in comparison with the normal devices.

(b) Microfocused devices include all the focusing and measuring electrodes on a small pad; they have a depth of investigation of only several centimeters. Because the geometric factor, which is related to the electrode spacing, is difficult to calculate for focused devices, calibration usually is carried out in a test well or pit where resistivities are known. When this is done, the voltage recorded can be calibrated directly in terms of resistivity. Zero resistivity can be checked when the entire electrode assembly is within a steel-cased interval of a well that is filled with water.

(c) Correction for bed thickness ( $h$ ) is only required if  $h$  is less than the length of  $M$ , which is 6 in. on some common tools. Resistivities on guard logs will approach  $R_o$ , and corrections usually will not be required if the following conditions are met:  $R_m/R_w < 5$ ,  $R_i/R_m > 50$ , and invasion is shallow. If these conditions are not met, correction charts and empirical equations are available for obtaining  $R_t$  (Pirson 1963).

(6) Microresistivity logging. A large number of microresistivity devices exist, but all employ short electrode spacing so that they have a shallow depth of investigation. They can be divided into two general groups: focused and non-focused. Both groups employ pads or

some kind of contact electrodes to reduce the effect of the borehole fluid. Non-focused sondes are designed mainly to determine the presence or absence of mud cake, but they also can provide very high-resolution lithologic detail. Names used for these logs include microlog, mini-log, contact log, and micro-survey log. Focused micro-resistivity devices also use small electrodes mounted on a rubber-covered pad forced to contact the wall of the hole hydraulically or with heavy spring pressure. The electrodes are a series of concentric rings less than 1 in. apart that function in a manner analogous to a laterolog system. The radius of investigation is from 76 to 127 mm (3 to 5 in.), which provides excellent lithologic detail beyond the mudcake, but probably is still within the invaded zone.

(7) Dipmeter logging.

(a) The dipmeter includes a variety of wall-contact microresistivity devices that are widely used in oil exploration to provide data on the strike and dip of bedding planes. The most advanced dipmeters employ four pads located 90 deg apart, oriented with respect to magnetic north by a magnetometer in the sonde. Older dipmeters used three pads, 120 deg apart. The modern dipmeter provides a large amount of information from a complex tool, so it is an expensive log to run. Furthermore, because of the amount and complexity of the data, the maximum benefit is derived from computer analysis and plotting of the results. Interpretation is based on the correlation of resistivity anomalies detected by the individual arms, and the calculation of the true depth at which those anomalies occur. The log from a four-arm tool has four resistivity curves and two caliper traces, which are recorded between opposite arms, so that the ellipticity of the hole can be determined. The Formation Microscanner is related to the dipmeter. It uses arrays of small electrodes to provide oriented conductance images of segments of the borehole wall scanned by the pads. These images are similar to an acoustic televiewer log but they do not include the entire borehole wall. The microscanner may be preferable in heavy muds or deviated holes.

(b) Although strike and dip can be determined from the analog record at the well using a stereo net, complete analysis is only possible with a computer. A computer program can make all necessary orientation and depth corrections and search for correlation between curves with a selected search interval. Computer output usually consists of a graphic plot and a listing of results. The graphic plot displays the depth, true-dip angle, and direction of dip by means of a symbol called a "tadpole" or an arrow. The angle and direction of the tool also is

displayed. Linear polar plots and cylindrical plots of the data also are available. A printout that lists all the interpreted data points, as well as the quality of the correlation between curves, also is provided.

(c) The dipmeter is a good source of information on the location and orientation of primary sedimentary structures over a wide variety of hole conditions. The acoustic televiewer can provide similar information under the proper conditions. The dipmeter also has been advertised widely as a fracture finder; however, it has some of the same limitations as the single-point resistance log when used for this purpose. Computer programs used to derive fracture locations and orientations from dipmeter logs are not as successful as those designed for bedding. Fractures usually are more irregular, with many intersections, and may have a wider range of dip angles within a short depth interval. The acoustic televiewer provides more accurate fracture information under most conditions.

(8) Induction logging.

(a) Principles. Induction-logging devices originally were designed to solve the problem of making resistivity measurements in oil-based drilling mud, where no conductive medium occurred between the tool and the formation. The basic induction-logging system is shown in Figure 7-16. A simple version of an induction probe contains two coils: one for transmitting an AC current, typically 20-40 KHz, into the surrounding rocks and a second for receiving the returning signal. The transmitted AC generates a time-varying primary magnetic field which induces a flow of eddy currents in conductive rocks penetrated by the drill hole. These eddy currents set up secondary magnetic fields which induce a voltage in the receiving coil. That signal is amplified and converted to DC before being transmitted up the cable. Magnitude of the received current is proportional to the electrical conductivity of the rocks. Induction logs measure conductivity, which is the reciprocal of resistivity. Additional coils usually are included to focus the current in a manner similar to that used in guard systems. Induction devices provide resistivity measurements regardless of whether the fluid in the well is air, mud, or water, and excellent results are obtained through plastic casing. The measurement of conductivity usually is inverted to provide curves of both resistivity and conductivity. The unit of measurement for conductivity is usually millisiemens per meter ( $mS/m$ ), but millimhos per meter and micromhos per centimeter are also used. One  $mS/m$  is equal to 1,000  $\Omega m$ . Calibration is checked by suspending the sonde in air, where the humidity is low, in order to obtain

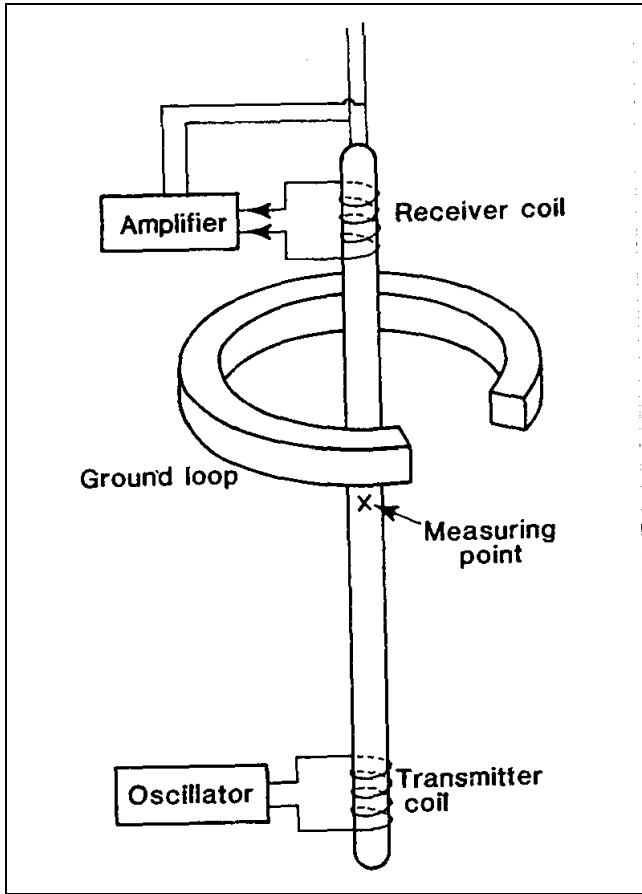

Figure 7-16. System used to make induction logs

a zero conductivity. A copper hoop is suspended around the sonde while it is in the air to simulate known resistivity values. The volume of investigation is a function of coil spacing, which varies among the sondes provided by different service companies. For most tools, the diameter of material investigated is 1.0 to 1.5 m (40 to 60 in.); for some tools, the signal produced by material closer to the probe is minimized. Figure 7-17 shows the relative response of a small-diameter, high-frequency, induction tool as a function of distance from the borehole axis. These smaller diameter tools, used for monitoring in the environmental field, can measure resistivities up to 1,000  $\Omega m$ .

(c) Interpretation and applications. Induction logs are becoming widely used on environmental projects for monitoring saline contaminant plumes by logging small-diameter, PVC- or fiberglass-cased wells. They also provide high-resolution information on lithology through casing and are excellent for this purpose when combined

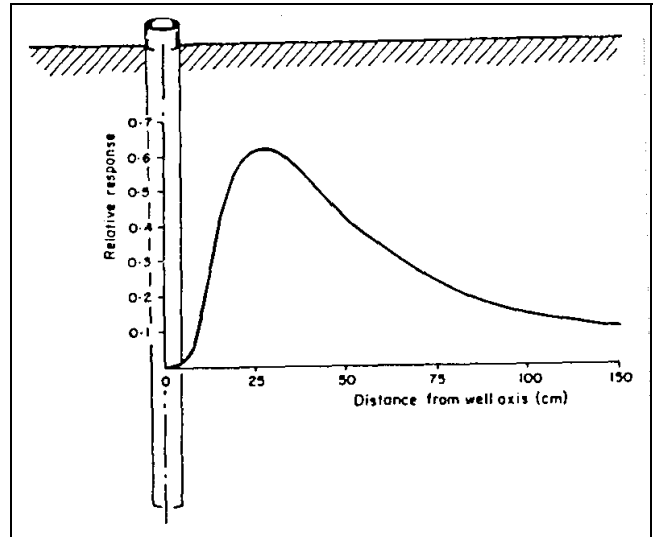

Figure 7-17. Relative response of an induction probe with radial distance from borehole axis (copyright permission granted by Geonics Limited)

with gamma logs. The response curve in Figure 7-17 is for a tool that can be used in 2-in.-diam casing. Figure 7-18 is a comparison of induction resistivity logs in an open and cased well with a 16-in. normal resistivity log. The open hole was 9 in. and drilled with a mud rotary system. The well was completed to a depth of 56 m with 4-in. Schedule 80 PVC casing and neat cement, bentonite seal, and gravel pack. Even in such a large diameter well with varying completion materials, the differences in resistivity are not significant.

(9) Nuclear logging.

(a) Principles. Nuclear logging includes all techniques that either detect the presence of unstable isotopes, or that create such isotopes in the vicinity of a borehole. Nuclear logs are unique because the penetrating capability of the particles and photons permits their detection through casing and annular materials, and they can be used regardless of the type of fluid in the borehole. Nuclear-logging techniques described in this manual include gamma, gamma spectrometry, gamma-gamma, and several different kinds of neutron logs. Radioactivity is measured by converting the particles or photons to electronic pulses, which then can be counted and sorted as a function of their energy. The detection of radiation is based on ionization that is directly or indirectly produced in the medium through which it passes. Three types of detectors presently are used for nuclear logging:



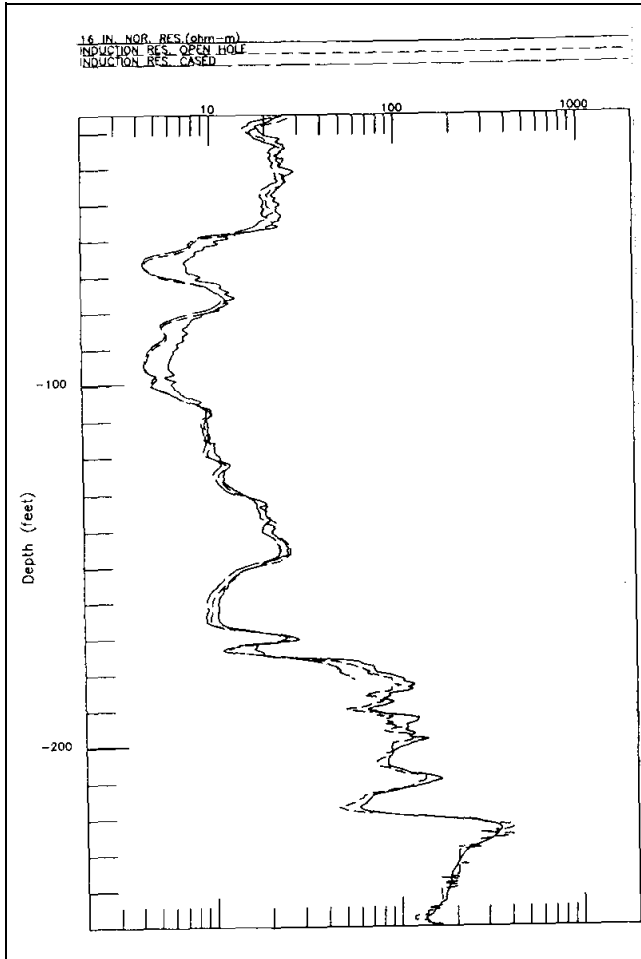

**Figure 7-18. Comparison of open-hole induction log with 16-in. normal log and induction log made after casing was installed (copyright permission granted by Colog, Inc.)**

scintillation crystals, Geiger-Mueller tubes, and proportional counters. Scintillation detectors are laboratory-grown crystals that produce a flash of light or scintillation when traversed by radiation. The scintillations are amplified in a photomultiplier tube to which the crystal is optically coupled, and the output is a pulse with amplitude proportional to that of the impinging radiation. This output can be used for spectral logging. The pulses output from a photomultiplier tube are small enough that they require additional amplification before they can be transmitted to the surface and counted. The number of pulses detected in a given radiation field is approximately proportional to the volume of the crystal, so probe sensitivity can be varied by changing crystal size. Scintillation crystals probably are the most widely used detectors for nuclear-well logging. Sodium-iodide crystals are used for

gamma logging, and lithium-iodide crystals and Helium 3 gas-filled tubes are used for many types of neutron logs.

(b) Interpretation and applications. The statistical nature of radioactive decay must be considered when running or interpreting nuclear logs. Half-life is the amount of time required for one half the atoms in a radioactive source to decay to a lower energy state. Half-life of different radioisotopes varies from fractions of a second to millions of years, and it has been accurately measured. In contrast, it is impossible to predict how many atoms will decay or gamma photons will be emitted within the short periods of time, in the range of seconds, that commonly are used for logging measurements. Photon emission follows a Poisson distribution; the standard deviation is equal to the square root of the number of disintegrations recorded. The accuracy of measurement is greater at high count rates and for a long measuring period. Time constant is an important adjustment on all analog nuclear-recording equipment. Time constant is the time, in seconds, over which the pulses are averaged. Time constant ( $t_c$ ) is defined as the time for the recorded signal level to rise to 63 percent of the total increase that occurred, or to fall to 37 percent of the total decrease that occurred. The true value in any radiation field is approached after five time constants, if the probe is still in the same bed that long. If the probe is moving too fast, or if the time constant is too long in thin-bedded materials, the true value never will be recorded before the probe moves out of the layer of interest. The logging speed, count rate being measured, vertical resolution required, and equipment variations have a significant effect on the selection of time constant so specific values cannot be recommended.

(c) Analog versus digital recording. The difference between an analog recording with a time constant of 1 sec and a digital recording with a sample time of 1 sec is shown in Figure 7-19. Digital recording is gradually replacing analog but some systems that digitize at the surface still use a time constant circuit to drive an analog recorder. Average or mean radioactivity is shown as the heavier line in Figure 7-19. Note that the digital system changes more rapidly because the time window used does not have a memory like the RC circuit used for time constant in analog measurements. Note also that the analog measurement did not reach the mean value for short time periods. Some commercial logs are recorded at a low sensitivity, long time constant, and high logging speed, so that real changes are small. This results in a smoother curve and thin beds may not be detected. Bed thickness and lag are additional factors related to the

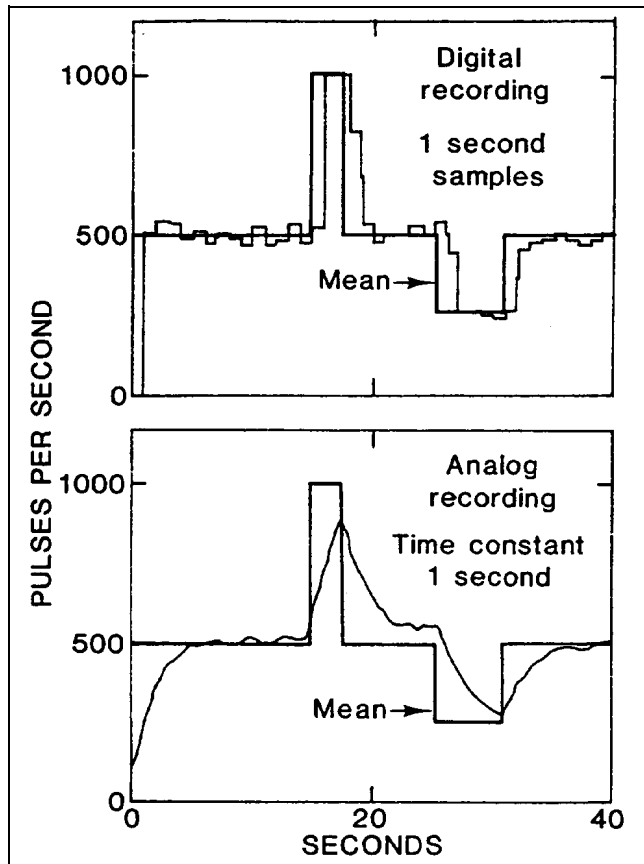

Figure 7-19. Comparison of a digital recording of a gamma signal with 1-s samples, to an analog recording with a 1-s time constant

speed at which nuclear logs are run. Lag ( $L$ ), in feet, is defined as the distance the detector moves during one time constant:

$$L = (St_c)/60$$

where

$S$  = logging speed, feet per minute

$t_c$  = time constant, seconds

(d) Lithologic contacts. The contacts between lithologic units on a nuclear log are shifted approximately the amount of lag. Furthermore, beds that are thinner than  $L$  are not defined. The general practice for locating lithologic contacts on nuclear logs is to place them at one-half of the maximum log amplitude for a given bed. Thus, if the average count rate for a gamma log in a sandstone was 100 pulses per second (PPS), and the average count rate for a shale was 200 PPS, the contact would be placed

at 150 PPS, using the half-amplitude rule. The true depth of the contact would be deeper by the amount of lag. See Figure 7-20 for an illustration of the relation of bed thickness, volume of investigation, and location of contacts for a neutron log. The principles are the same for other types of nuclear logs.

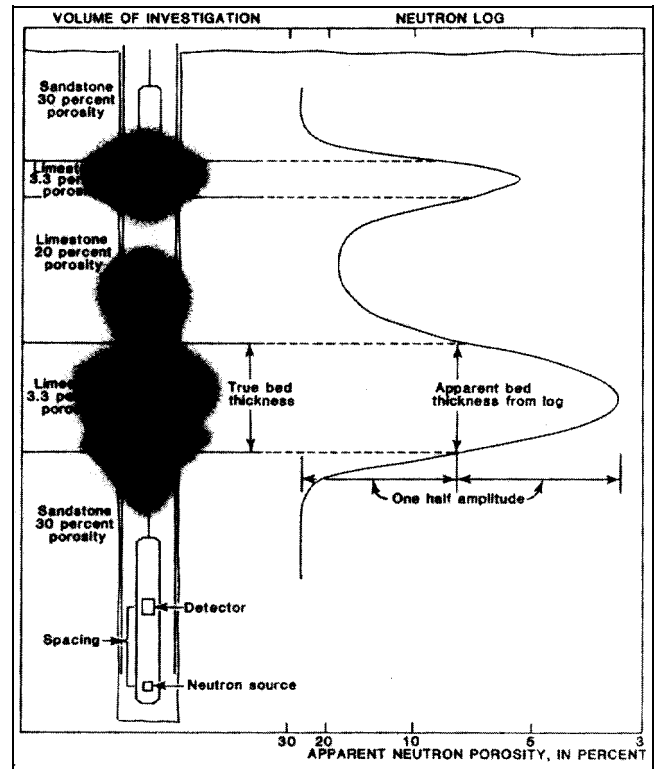

Figure 7-20. Theoretical response of a neutron probe to changes in porosity and bed thickness. The shaded area represents the volume of investigation at different probe positions

(e) Regulation. Use and transportation of radioactive materials is regulated by both Federal and State government agencies. Because of the numerous agencies involved and the frequent changes in regulations, specific information on the subject cannot be provided in this manual. A potential user must consult the appropriate government agency for regulations that apply to the specific type and area of use. The loss of most probes can be prevented if the proper logging procedures are followed. Probes containing radioactive sources need to be the last to be run in an uncased well; they never are run if other probes encounter problems.

(10) Gamma logging.

(a) Principles. Gamma logs, also called gamma-ray logs or natural-gamma logs, are the most widely used

nuclear logs for most applications. The most common use is for identification of lithology and stratigraphic correlation, and for this reason gamma detectors are often included in multi-parameter logging tools. Gamma logs provide a record of total gamma radiation detected in a borehole and are useful over a very wide range of borehole conditions. The petroleum industry has adopted the American Petroleum Institute (API) gamma ray unit as the standard for scales on gamma logs. The API gamma-ray unit is defined as 1/200 of the difference in deflection of a gamma log between an interval of very low activity in the calibration pit and the interval that contains the same relative concentrations of radioisotopes as an average shale, but approximately twice the total activity. The API gamma calibration pit is located at the University of Houston. The API values of field standards can be determined when that pit is used so that reference values are available when logging. The volume of material investigated by a gamma probe is related to the energy of the radiation measured, the density of the material through which that radiation must pass, and the design of the probe. Under most conditions, 90 percent of the gamma radiation detected probably originates from material within 150 to 300 mm (6 to 12 in.) of the borehole wall.

(b) Interpretation and applications. In rocks that are not contaminated by artificial radioisotopes, the most significant naturally occurring gamma-emitting radioisotopes are potassium-40 and daughter products of the uranium- and thorium-decay series. If gamma-emitting artificial radioisotopes have been introduced by man into the groundwater system, they will produce part of the radiation measured, but they cannot be identified unless gamma spectral-logging equipment is used. Average concentrations in 200 shale samples from different locations in the United States indicate that 19 percent of the radioactivity of shale comes from Potassium-40, 47 percent from the Uranium series, and 34 percent from the Thorium series, but these ratios can vary significantly. Only gamma spectral logging can provide the identification and relative concentrations of the natural and man-made radioisotopes that produce the total radioactivity measured by a gamma log. Borehole-gamma spectrometry has considerable application to the monitoring of radioactive waste migration and it also can provide more diagnostic information on lithology, particularly the identification of clay minerals. Uranium and thorium are concentrated in clay by the processes of adsorption and ion exchange. Some clays are rich in potassium. Fine-grained detrital sediments that contain abundant clay tend to be more radioactive than quartz sands and carbonates, although numerous exceptions to this norm occur. Rocks can be characterized according to their usual gamma

intensity, but knowledge of the local geology is needed to identify the numerous exceptions to the classification shown in Figure 7-21. Coal, limestone, and dolomite usually are less radioactive than shale; however, all these rocks can contain deposits of uranium and can be quite radioactive. Basic igneous rocks usually are less radioactive than silicic igneous rocks, but exceptions are known. Several reasons exist for the considerable variability in the radioactivity of rocks. Uranium and thorium are trace elements and are not important in the genesis of rocks. Uranium also is soluble in groundwater under some conditions; so solution, migration, and precipitation may cause redistribution at any time.

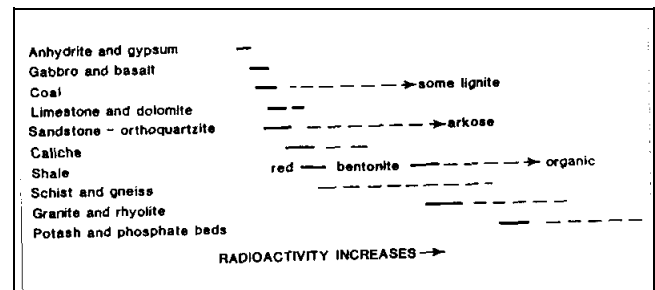

Figure 7-21. Relative radioactivity of some common rocks

(c) Background information. Because of frequent variations from the typical response of gamma logs to lithology, some background information on each new area is needed to reduce the possibility of errors in interpretation. Gamma logs are used for correlation of rock units; however, this approach can lead to significant errors without an understanding of their response within the area being studied. For example, gradual lateral change in grain size or increase in arkosic materials in a sandstone may change the response of gamma logs. In igneous rocks, gamma intensity is greater in the silicic rocks, such as granite, than in basic rocks, such as andesite. Orthoclase and biotite are two minerals that contain radioisotopes in igneous rocks; they can contribute to the radioactivity of sedimentary rocks if chemical decomposition has not been too great. Gamma logs are used widely in the petroleum industry to establish the clay or shale content of reservoir rocks. This application also is valid in groundwater studies where laboratory data support such a relation. Figure 7-2 is a computer-plotted cross section of four test holes in the Chicago area. The shading emphasizes the relation between the induction resistivity and gamma logs which aided in drawing the correlation lines using the computer program. The increase in radioactivity below a depth of 300 ft (91 m) is caused by an increase in shale or clay content. Above that depth

most of the rocks are dolostones. In this area it was found that gamma log response was quantitatively related to clay content and that the gamma logs could be used to correct porosity calculated from gamma-gamma density logs. See Figure 7-1 for a description of the rocks penetrated by these test holes.

(d) Amplitude. The amplitude of gamma-log deflections is changed by any borehole conditions that alter the density of the material through which the gamma photons must pass or the length of the travel path. Thus, casing and cement will reduce the recorded radiation, as will large diameter wells. The correction factor for water in a borehole as compared to the same borehole filled with air is 1.024 for a 2.25-in.-diam hole and 1.115, 1.205 and 1.296 for 4.5-, 6.5- and 8.5-in. boreholes, respectively. Correction for steel casing wall thickness varies almost linearly from 1.141 for 0.0625 in thickness to 1.891 for 0.375 in thickness. The type of borehole fluid has a very minor effect, unless the hole is very large in diameter or the mud contains radioactive clay or sylvite.

(e) Probe position. The position of a probe in the borehole can have an effect on a gamma log. Most probes are naturally decentralized, or running along the borehole wall, because of borehole deviation but if the probe moves to a centralized position, an error is introduced. Changes in gamma-log response over a period of time are not rare. Changes in gamma response in 1 year, that apparently were caused by migration of uranium daughter products along fractures, have been reported (Keys 1984).

(11) Gamma-gamma logging.

(a) Principles. Gamma-gamma logs, also called density logs, are records of the radiation from a gamma source in the probe, after it is attenuated and backscattered in the borehole and surrounding rocks. The logs can be calibrated in terms of bulk density under the proper conditions and converted to porosity if grain and fluid density are known. Gamma-gamma probes contain a source of gamma radiation, usually cesium-137 in newer probes, and one or two gamma detectors. Detectors in a gamma-gamma probe are shielded from direct radiation from the source by heavy metal, often lead or a tungsten alloy. Single detector probes, termed "4 pi," are not focused and thus are more affected by borehole parameters. Modern gamma-gamma probes are decentralized and side-collimated with two detectors. Side collimation with heavy metal tends to focus the radiation from the source and to limit the detected radiation to that part of the wall of the hole in contact with the source and detectors. The

decentralizing caliper arm also provides a log of hole diameter. Modern tools are called borehole-compensated or borehole-corrected, but they still exhibit some borehole diameter effects. The ratio of the count rates for the near and far detectors is plotted against bulk density, either in the logging equipment, or preferably later so that algorithms can be changed (Scott 1977). This ratio reduces borehole diameter effects because the near detector has a smaller radius of investigation than the far detector and is thus more affected by changes in diameter. Gamma-gamma logging is based on the principle that the attenuation of gamma radiation, as it passes through the borehole and surrounding rocks, is related to the electron density of those rocks. If a probe detects only radiation resulting from Compton scattering, the count rate will be inversely proportional to the electron density of the material through which the radiation passes. Electron density is approximately proportional to bulk density for most materials that are logged. A correction for the "Z To A" ratio needs to be applied for any minerals that do not have the same ratio of atomic number to atomic mass as the calibration environment. The electron density of water is 1.11 g/cc versus a bulk density of 1 g/cc and some companies may make this correction. Like other logging systems, calibration of gamma-gamma response is best done in pits designed for that purpose. Calibration can be done in porosity pits like the American Petroleum Institute neutron pit in Houston or in pits maintained by commercial-service companies. A set of bulk-density pits is available for free use by anyone at the Denver Federal Center. Onsite standardization of probe response usually is done with large blocks of aluminum, magnesium, or lucite that are machined with a groove that tightly fits the source and detector section of the probe. The blocks need to be large enough that effects of the environment are minimized, and they need to be located off the ground and away from a logging truck that may contain radioactive sources.

(b) Volume of investigation. The volume of investigation of a gamma-gamma probe probably has an average radius of 127 to 152 mm (5 to 6 in.); 90 percent of the pulses recorded originate from within this distance. However, the volume of investigation is a function of many factors. The density of the material being logged and any casing, cement, or mud through which the radiation must pass have a significant effect on the distance gamma photons will travel before being stopped. Within limits, the greater the spacing between source and detector, the larger the volume of investigation. Standoff error is caused when a side-collimated, decentralized probe or skid is separated from the borehole wall by mudcake or wall roughness. According to Scott (1977), standoff

errors of 10 mm (0.4 in.) or more may be corrected accurately using the algorithms he developed.

(c) Interpretation and applications. Gamma-gamma logs may be used to distinguish lithologic units and to determine well construction, in addition to determining bulk density, porosity, and moisture content, when properly calibrated. The chief use of gamma-gamma logs has been for determining bulk density that can be converted to porosity. Gamma-gamma logs conventionally are recorded with bulk density increasing to the right, which means that porosity increases to the left as it does on conventionally plotted neutron and acoustic velocity logs. Although commercial gamma-gamma logs often have a scale in porosity, the log response is related directly to electron density, which may be related to bulk density by calibration and correction for Z-A errors. The accuracy of bulk-density determinations with these logs is reported by various authors to be from 0.03 to 0.05 g/cc. Figure 7-22 is a plot of bulk density from laboratory analyses of core versus density log values from a study in Canada (Hoffman, Fenton, and Pawlowica 1991). It shows how accurate density logs can be under the right conditions. The best results are obtained with gamma-gamma logs in rocks of low-bulk density or high porosity. Bulk density can be converted to porosity by the following equation: porosity = grain density minus bulk density divided by grain density minus fluid density. Bulk density may be derived from a calibrated and corrected log.

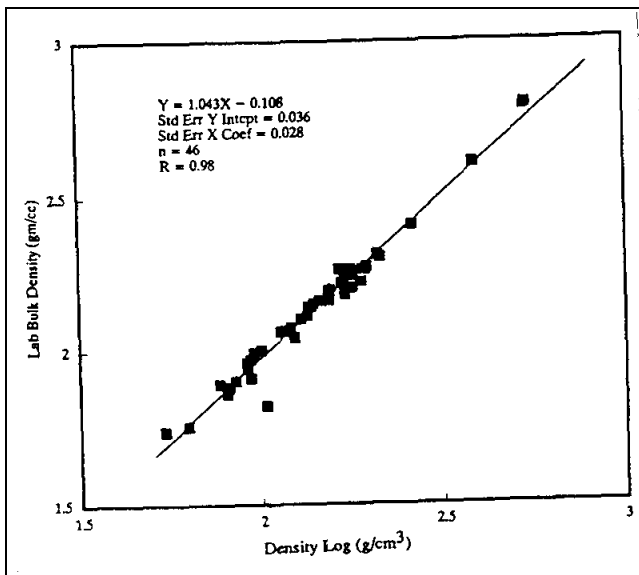

Figure 7-22. Plot of laboratory measurements of bulk density versus gamma-gamma density log response in the same borehole (Hoffman, Fenton, and Pawlowicz 1991; copyright permission granted by Alberta Research Council)

Fluid density is 1 g/cc for most non-petroleum applications, where the rock is saturated. Grain or mineral density may be obtained from most mineralogy texts; grain density is 2.65 g/cc for quartz; 2.71 g/cc commonly is used for limestone, and 2.87 g/cc commonly is used for dolomite. At the Chicago site shown in Figures 7-1 and 8-3, gamma log response was used to correct the grain density entered in the porosity equation. Low gamma response indicated mostly dolomite, and higher gamma response indicated an increase in clay with a lower grain density than dolomite. At many sites gamma-gamma logs provide more accurate porosity data than neutron and acoustic velocity logs. Figure 7-23 is an example of a comparison of data from the three types of porosity sensing logs versus core data at a Superfund site in Oklahoma (Keys 1993). Because moisture content affects the bulk density of rocks, gamma-gamma logs can be used to record changes in moisture above the water surface. Thus they can be used in the same way as neutron logs to monitor the downward migration of water from waste disposal or artificial recharge ponds.

(d) Well construction. The effect of well construction on gamma-gamma logs can be used to locate cement tops, gravel-pack fill-up, or one string of casing outside of another. Gamma-gamma logs for this application are discussed in the section of this manual on well-completion logs.

(12) Neutron logging.

(a) Principles. Neutron logs are made with a source of neutrons in the probe and detectors that provide a record of the interactions that occur in the vicinity of the borehole. Most of these neutron interactions are related to the amount of hydrogen present, which, in groundwater environments, is largely a function of the water content of the rocks penetrated by the drill hole. Neutron probes contain a source that emits high-energy neutrons. The most common neutron source used in porosity logging tools is americium-beryllium, in sizes that range from approximately 1 to 25 Curies. Moisture tools may use a source as small as 100 millicuries. Two different neutron-logging techniques are used in groundwater studies: Neutron probes with a large source and long spacing are used for measuring saturated porosity and moisture content in a wide range of borehole diameters; and second, probes with a small source and short spacing are used for measuring moisture content in small diameter monitoring wells. Three general types of neutron-porosity logs exist: Neutron-epithermal neutron, neutron-thermal neutron, and neutron-gamma. Cadmium foil may be used

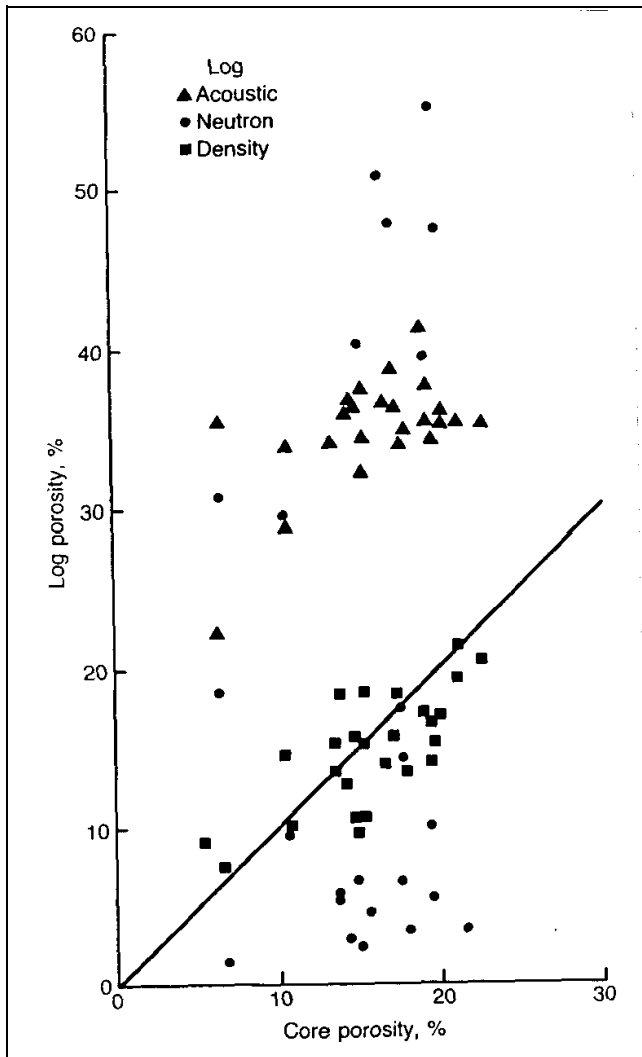

**Figure 7-23. Comparison of laboratory measurements of porosity versus acoustic, neutron, and density log response in the same borehole**

to shield crystal or Helium-3 detectors from thermal neutrons. Neutron-epithermal neutron logs are least affected by the chemical composition of the rocks logged. Two or more detectors are used in modern neutron tools, and they may be collimated and decentralized by a caliper arm. The ratio of the near to the far detector provides logs that are less affected by borehole parameters than single-detector logs.

(b) Moderating neutrons. Fast neutrons, emitted by a source, undergo three basic types of reactions with matter in and adjacent to the borehole as they lose energy and ultimately are captured: inelastic scatter, elastic scatter, and absorption or capture. In elastic scatter, the mass of the scattering element controls the loss of energy by the

neutron. Light elements are most effective in moderating, or slowing neutrons, whereas heavy elements have little effect on neutron velocity or energy. Hydrogen is the element most effective in moderating neutrons because it has the same mass as a neutron. Because hydrogen is the most effective moderating element, the cloud of epithermal and thermal neutrons occurs closer to the source in rocks with a large hydrogen content than in rocks with a small hydrogen or water content. The moderating and capture processes result in the number of epithermal and thermal neutrons and capture gamma photons being inversely related to the hydrogen content of the rocks, at source-to-detector spacing greater than approximately 300 mm (11.8 in.). If detectors are located closer than 300 mm from the source, as in moisture probes, the number of moderated and captured neutrons increases with increasing hydrogen content.

(c) Volume of investigation. The volume of investigation of a neutron probe is related closely to the content of hydrogen or other strong neutron absorbers in the material surrounding the probe, the spacing between the source and detector, and the energy of the neutrons. In sand with a saturated porosity of 35 percent, three different types of neutron probes received 90 percent of the recorded signal within 170, 236, and 262 mm of the borehole wall. In dry rocks the radius of investigation may be several meters. The reference depth, or point of measurement, on a probe may change somewhat if significant differences in water content are logged. Increasing the source-to-detector spacing increases the volume of investigation in the vertical direction as well as in the horizontal direction, into the rock. This increased volume decreases thin-bed resolution as demonstrated in Figure 7-20. The hypothetical volume of investigation is shown by shading in the figure. Note that size and shape of this volume are shown to change as a function of the porosity as the probe moves up the hole. The log only gives an approximately correct value for porosity and thickness when the volume of investigation is entirely within the bed being logged. Thus, in Figure 7-20, the upper thin limestone bed with 3.3 percent porosity is indicated by the log to have a much higher porosity and greater apparent thickness than the lower bed with a porosity of 3.3 percent. The usual technique for determining bed thickness from any type of nuclear log is to make the measurement at one-half the maximum amplitude of the deflection that represents that bed, as shown on the figure.

(d) Calibration. Calibration of all neutron-logging systems used in the petroleum industry is based on the API calibration pit in Houston, Texas. The pit contains quarried limestone blocks that have average porosities of

1.884, 19.23, and 26.63 percent. These values have been rounded by the American Petroleum Institute to 1.9, 19, and 26 percent, and the 19-percent block has been assigned the value of 1,000 API neutron units (Belknap et al. 1959). Figure 7-24 shows calibration data for a compensated neutron probe in the API pit (Keys 1990). Although the API pit is the widely accepted primary standard, it is only valid for limestone, so that most large logging companies maintain their own calibration facilities for other rock types, like dolomite and sandstone. Careful evaluation of laboratory analyses of core samples may lead to a valid calibration, but scatter of data points is to be expected. Regardless of how primary calibration is carried out, field standardization must be done at the time of calibration and frequently during logging operations. The most practical field standards permit the checking of probe response with the source installed in a reproducible environment that has a high hydrogen content. Although a plastic sleeve may be used, it must be quite heavy to be large enough to cover both source and detectors and thick enough to reduce outside effects.

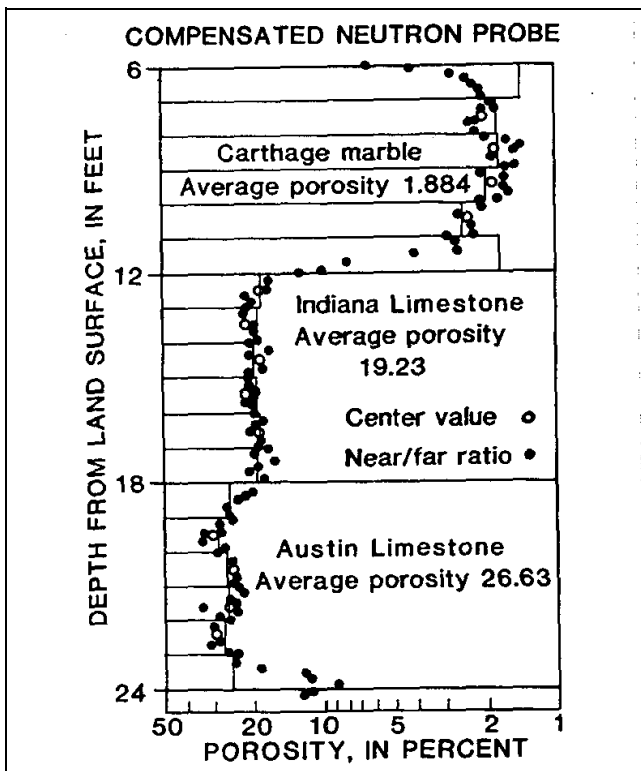

Figure 7-24. Calibration data for a compensated neutron porosity probe in the API limestone pit

(e) Interpretation. In many rocks, the hydrogen content is related to the amount of water in the pore spaces. This relation is affected by the chemical

composition of the water, hydrogen in some minerals and bound water in shales. Neutron logs are affected by many of the same borehole parameters that affect gamma-gamma logs, although usually to a lesser degree. These extraneous effects include borehole diameter, mud cake or stand off, salinity of the borehole and interstitial fluids, mud weight, thickness of casing and cement, temperature and pressure, and elemental composition of the rock matrix. Matrix effects are considered part of the interpretation process and may be analyzed by cross-plotting techniques, as illustrated in Figure 7-3. Casing does not cause a major shift on most neutron logs, as it typically does on a gamma-gamma log. Neutron logs run through drill stem do not show the location of collars as a gamma-gamma log does. Plastic pipe of constant thickness merely causes a shift in log response similar to, but of lower magnitude than, that caused by the water level in a small-diameter well. The short spacing used in moisture probes reduces the volume of investigation, so that borehole effects are increased. For this reason, boreholes to be used for logging with a moisture probe need to be drilled as small as possible. The annular space between casing and borehole wall also needs to be small, and the probe needs to fit the casing tightly. Neutron logs are most suitable for detecting small changes in porosity at low porosities; gamma-gamma logs are more sensitive to small changes at high porosities. Although the interpretation of neutron logs for porosity and moisture content are stressed as primary applications, much use has been made of the logs for determining lithology. Like gamma logs, they can be used for lithology and stratigraphic correlation over a wide range of borehole conditions. Figure 7-1 shows how neutron and gamma logs relate to the stratigraphic units in a test hole near Chicago.

(f) Applications. Neutron-activation logging has potential for application to groundwater quality problems, because this technique permits the remote identification of elements present in the borehole and adjacent rocks under a wide variety of borehole conditions. Neutron activation produces radioisotopes from stable isotopes; the parent or stable isotope may be identified by the energy of the gamma radiation emitted and its half-life, using a gamma spectral probe (Keys and Boulogne 1969).

(13) Acoustic logging. Acoustic logging includes those techniques that use a transducer to transmit an acoustic wave through the fluid in the well and surrounding elastic materials. Several different types of acoustic logs are used, based on the frequencies used, the way the signal is recorded, and the purpose of the log. All these logs require fluid in the well to couple the signal to the surrounding rocks. Four types will be described here:

acoustic velocity, acoustic wave form, cement bond, and acoustic televiewer.

(14) Acoustic-velocity logging.

(a) Principles. Acoustic-velocity logs, also called sonic logs or transit-time logs, are a record of the travel time of an acoustic wave from one or more transmitters to receivers in the probe. Acoustic energy travels through the fluid in the well and through surrounding materials at a velocity that is related to the lithology and porosity of the rocks. Most acoustic-velocity probes employ magnetorestrictive or piezoelectric transducers that convert electrical energy to acoustic energy. Most of the transducers are pulsed from 2 to 10 or more times per second, and the acoustic energy emitted has a frequency in the range of 20 to 35 kHz. Probes are constructed of low-velocity materials, producing the shortest travel path for the acoustic pulse through the borehole fluid and the adjacent rocks, which have a velocity faster than that of the fluid. Acoustic probes are centralized with bow springs or rubber fingers so the travel path to and from the rock will be of consistent length. Some of the energy moving through the rock is refracted back to the receivers. The receivers reconvert the acoustic energy to an electrical signal, which is transmitted up the cable. At the surface, the entire signal may be recorded digitally for acoustic wave-form logging, or the transit time between two receivers may be recorded for velocity logging. Amplitude of portions of the acoustic wave also may be recorded; that technique is described later under wave-form logging.

(b) Acoustic energy components. Acoustic energy transmitted in the borehole and adjacent rocks is divided into several components; the most important for this discussion are compressional (P) and shear wave (S) components. Standard acoustic-velocity logs are based on the arrival of the compressional wave. Compressional and shear waves at near and far receivers, along with the fluid waves that are transmitted through the borehole, are shown in Figure 7-25 (Paillet and White 1982). Most acoustic-velocity probes have paired receivers located a foot apart; some probes have several pairs of receivers with different spacing that may be selected from the surface. P-waves have a higher velocity and lower amplitude than shear waves, or S-waves. S-waves have a velocity about one half that of P-waves and are characterized by particle movement perpendicular to the direction of wave propagation.

(c) Tracking circuits. Acoustic-velocity logging modules contain a tracking circuit that detects the arrival

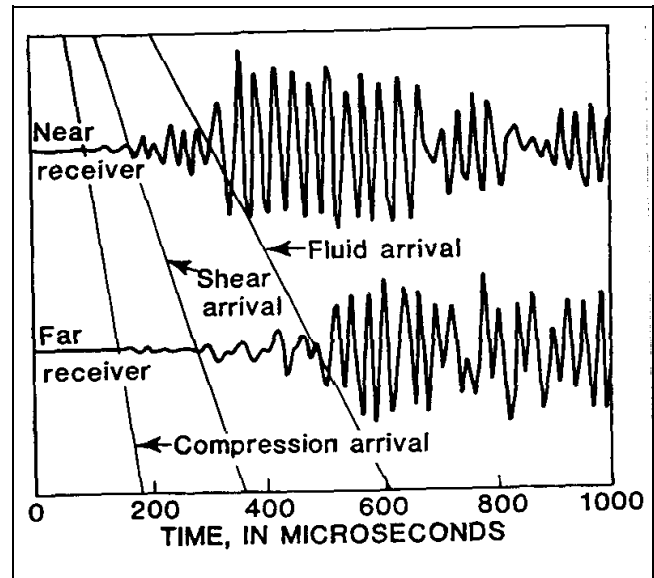

Figure 7-25. Acoustic wave forms for a two-receiver system

of the P-wave using a threshold amplitude or algorithm selected by the operator. If the wave form is digitized in the field it is frequently possible to improve acoustic velocity logs by modifying the technique used to pick the first arrival. Amplitude of the transmitted signal and the received signal may be controlled from the surface, along with the height of the detection threshold. A circuit is employed to convert the difference in time of arrival at the two detectors to transit time ( $t$ ) in  $\mu\text{s}/\text{ft}$ . Acoustic-velocity logs are recorded with interval transit time increasing from right to left; porosity also will increase to the left, as it does on conventionally plotted neutron and gamma-gamma logs.

(d) Interpretation and applications. For rocks with uniformly distributed, intergranular pore spaces, porosity usually is derived from the Wyllie time-average equation. This equation is based on the theory that the path of an acoustic wave through saturated rock consists of two velocities in series, the velocity in the fluid  $V_f$  and the velocity in the rock matrix  $V_m$ . The length of the path in the fluid is equal to the porosity ( $\phi$ ); the length of the path in the rock matrix is equal to  $1-\phi$ . The time-average equation can be expressed as:

$$1/V_L = t = \phi/V_f + (1 - \phi)/V_m$$

where

$V_L$  = velocity of the rock from a log



For calculation of porosity, the time-average equation is converted to the form:

$$\phi = (t_L - t_m)/(t_f - t_m) \quad (7-3)$$

where

$t_L$  = transit time from the log

$t_m$  = transit time of the wave in the matrix

$t_f$  = transit time in the fluid

Velocities and transit times for some common rocks and fluids are provided in Table 7-2. Note that the range can be very large, so laboratory measurements or background experience in specific rocks may be needed to calculate accurate porosities. The interval transit-time scale usually is accurate within 1  $\mu$ s/ft on most acoustic-velocity logs; however, it should be checked, if possible. The difference in arrival of the P-wave at two receivers can be read directly from a calibrated oscilloscope, which is an essential part of any acoustic-logging system unless the wave form is digitized in the tool. In this case a computer can be used to observe the wave forms. Calibration also can be accomplished using core samples analyzed in the laboratory for acoustic velocity and porosity. The response of a velocity probe can be checked onsite with a piece of steel pipe cut in half lengthwise. The tool can be laid in the pipe and dams made at both ends with flexible caulking, so that half of the transmitters and receivers can be covered with water. Steel has a velocity ranging from

17,000 to 20,000 ft/s, which can be used to check the calibration of the sonde. It is possible to make the same check in a drill hole that contains free-hanging steel pipe.

(e) Radius of investigation. The radius of investigation of an acoustic-velocity probe is reported to be approximately three times the wavelength (Pirson 1963). The wavelength is equal to the velocity divided by the frequency. At a frequency of 20,000 Hz, the radius of investigation theoretically is about 0.23 m (0.75 ft) for unconsolidated rocks with a velocity of 1,500 m/s (5,000 ft/s), and 1.1 m (3.65 ft) for very hard rocks with a velocity of 7,600 m/s (25,000 ft/s). A lower transmitter frequency will increase the volume of investigation, but it will decrease the resolution of small features, such as fractures.

(f) Cycle skipping. One of the most obvious problems on acoustic-velocity logs is cycle skipping, caused by the amplitude of the first compressional cycle being too low for detection, or by pre-arrival noise of sufficient amplitude to be detected. If the first cycle is detected at the near receiver and the second cycle is detected at the far receiver, the resulting transit time will be much too long, and the log will show a very sharp deflection. Often signal amplitude will vary above and below detection level, which causes rapid fluctuations in the log trace, which can be recognized as cycle skips. Cycle skipping frequently is blamed on gas in the well; however, any condition that causes the compressional wave to drop below detection level will produce cycle skipping on the log. Causes include improper adjustment of signal or detection level, fractures or washouts, high-attenuation rocks, and gas in the fluid. Cycle skipping can be used to locate fractures in some wells, but corroborating evidence is necessary.

(g) Lithologic factors. Acoustic velocity in porous media is dependent on such lithologic factors as: the type of matrix; density; size, distribution, and type of grains and pore spaces; degree of cementation; and the elastic properties of the interstitial fluids. The widely used time average equation does not account for most of these factors, but it has been found to produce reasonably correct porosity values under most conditions. Figure 7-26 is a plot of porosity values measured on core versus transit time from an acoustic-velocity log, for a sequence of basin-fill sedimentary and volcanic rocks in Idaho. The correlation coefficient for the core and log data from this well is 0.87, even though a wide range of rock types with different matrix velocities were logged. Acoustic-velocity logs are very useful for providing information on

**Table 7-2**  
**Compressional-Wave Velocity and Transit Time in Some Common Rocks and Fluids [Single values are averages]**

Rock or Fluid Type	Velocity		Transit time ( $\mu$ s/ft)
	(m/s)	(ft/s)	
Fresh water	1,500	5,000	200.0
Brine	1,600	5,300	189.0
Sandstone			
Unconsolidated	4,600-5,200	15,000-17,000	58.8-66.7
Consolidated	5,800	19,000	52.6
Shale	1,800-4,900	6,000-16,000	62.5-167.0
Limestone	5,800-6,400	19,000-21,000+	47.6-52.6
Dolomite	6,400-7,300	21,000-24,000	42.0-47.6
Anhydrite	6,100	20,000	50.0
Granite	5,800-6,100	19,000-20,000	50.0-52.5
Gabbro	7,200	23,600	42.4

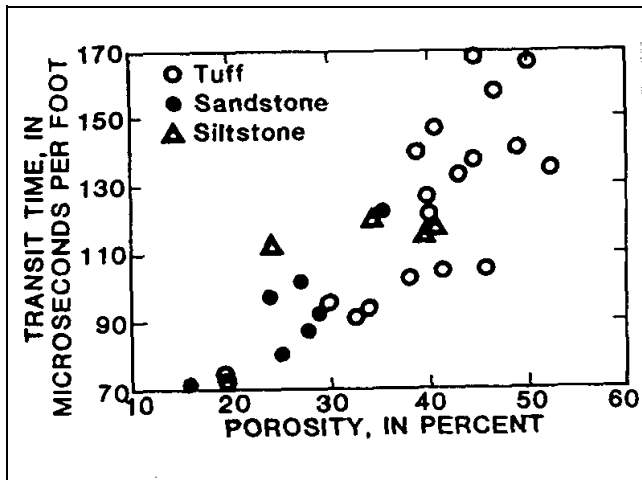

Figure 7-26. Relation of acoustic-transit time to porosity for tuff, sandstone, and siltstone, Raft River geothermal reservoir, Idaho

lithology and porosity under a fairly wide range of conditions. They usually are limited to consolidated materials penetrated by uncased, fluid-filled wells; however, lithologic information can be obtained when casing is well bonded to the rocks. Resolution of thin beds is good when 1-ft receiver spacing is used; contacts usually are marked by sharp deflections.

(h) Secondary porosity. In some geohydrologic environments, such as carbonates, porosity from an acoustic-velocity log and from a neutron log or core can be cross-plotted to identify intervals of secondary porosity. Acoustic-velocity logs do not detect most nonuniformly distributed secondary porosity, whereas neutron logs respond to all water-filled pore spaces. This is demonstrated in Figure 7-3, computer-generated cross plot of the neutron log versus acoustic-velocity log for Madison limestone test well No. 1 (Keys 1986). In the permeable intervals identified on flowmeter logs, many acoustic-log porosities were lower than the corresponding neutron-log and core values because of secondary porosity (Figure 7-3).

(15) Acoustic wave-form logging.

(a) Principles. Considerable information on lithology and structure is available through analyses of the various components of a received acoustic signal. Analyses may include amplitude changes, ratios of the velocities of various components of the wave train, and frequency-dependent effects. Hearst and Nelson (1985) present a broad discussion on acoustic logging and the propagation of waves in geologic media. There are two main cate-

gories of waves in a borehole: (a) refracted waves, and (b) guided waves. Refracted waves travel from the transmitter through the fluid and are refracted at the borehole wall, where they travel through the rock until refracted again through the fluid to the receivers. Guided waves travel in the borehole fluid or at the borehole wall/fluid interface. Cement-bond logs are included in this section, because wave-form data are needed to increase the accuracy of interpretation of these logs. Acoustic wave forms can be recorded digitally, pictures can be made of the display on an oscilloscope, or a variable-density log can be made. The variable-density log (VDL) or 3-dimensional (3-D) velocity log is recorded photographically, so that variations in darkness of the record are related to changes in amplitude of cycles in the wave form. Figure 7-27 includes a VDL display. The banded display on the right is the VDL, which is a representation of the wave train in time from transmitter pulse. Frequency of the waves is related to the width of the black and white or grey bands. The grey scale scheme in this VDL is such that white represents high-amplitude negative wave pulses, grey the low-amplitude waves, and black represents high-amplitude positive pulses. A digitized wave form log is the most useful type of record, because data can be analyzed quantitatively. Velocities and amplitudes of all parts of the recorded wave form can be measured from a digital record. Furthermore, digitized wave form data enable acoustic velocity or transit time logs to be corrected later where the algorithm that detected the first arrival was not functioning properly.

(b) Interpretation and applications. Elastic properties of rocks can be calculated from the velocities of P- and S-waves and from corrected bulk density from a gamma-gamma log. [Also see the discussion in paragraph 3-1a(1)(d).] The elastic properties or constants that can be determined are shear modulus, Poisson's ratio, Young's modulus, and bulk modulus (Yearsley and Crowder 1990). The shear modulus is defined in terms of density and S-wave velocity, as given in the following equation:

$$G = p_b V_s^2 \tag{7-4}$$

where

$G$  = shear modulus

$p_b$  = bulk, mass density

$V_s$  = shear-wave velocity

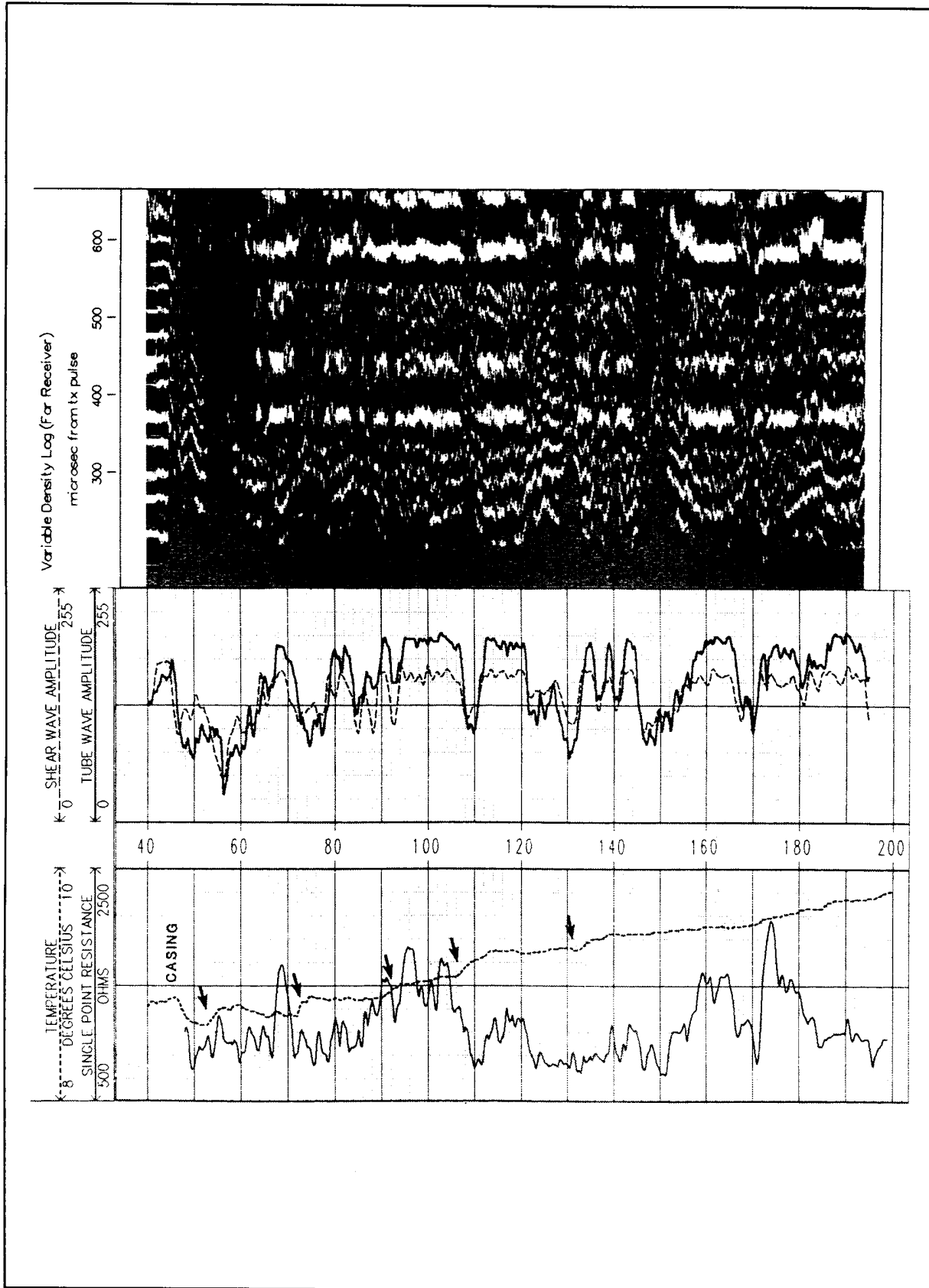

Figure 7-27. Composite of logs showing the location of permeable fractures indicated by the arrows at changes in temperature gradient and by low tube and shear wave amplitude (Yearsley and Crowder 1990; copyright permission granted by Colog, Inc.)

Poisson's ratio  $\nu$  is the ratio between strain in the direction of principal stress and strain in either transverse direction, and is defined in terms of P- and S-wave velocities by the following [also Equation 3-1]:

$$\nu = (a^2 - 2)/[2(a^2 - 1)] \quad (7-5)$$

where

$\nu$  = Poisson's ratio

$$a = V_p/V_s$$

$V_p$  = P-wave velocity

Young's modulus is the factor of proportionality between stress and strain and is fundamentally related to the material constants given above by the following equation:

$$E = 2G(1 + \nu) \quad (7-6)$$

where

$E$  = Young's modulus

It should be noted that the above relationships were derived for homogeneous, isotropic conditions, which do not exist in the geologic environment. Still, in practice these expressions provide useful engineering estimates for the elastic properties of rocks, and an analytical overview of the interrelationships among density, velocity, and moduli. For example, Equation 7-4 reveals that the shear modulus varies directly with density, but with the square of shear velocity, indicating the strong dependency of the shear modulus on transverse velocity. It is interesting to note from Equation 7-5 that Poisson's ratio is not physically meaningful for compression/shear velocity ( $V_p/V_s$ ) ratios less than 1.42 (Poisson's ratio becomes negative). In general, higher Poisson's ratios indicate less competent rock. Ice, which is more deformable than most rock, has a  $V_p/V_s$  ratio of approximately 2.0, which corresponds to a Poisson's ratio of 0.33. The result of this type of analysis is the engineering properties log shown in Figure 7-28. Competent rock below 44 m stands out clearly in Figure 7-28 with moduli of nearly twice the weathered rock and five times the fractured rock. However, note the minor fracture zones in evidence in the competent rock mass, indicated by excursions to the left on both the moduli curves and velocity curve. The major fracture zones in the overlying rock are shown by extremely low shear moduli of less than 14 gigapascals (two million psi).

The core-derived rock quality determination plotted in Figure 7-28 grossly indicates the difference between the competent rock mass and the overlying weathered and fractured rock in this core hole.

(c) Tube waves. Paillet (1980 and 1981) describes the characterization of fractures by various acoustic techniques. A significant finding was that a semiquantitative correlation exists between the attenuation of tube-wave amplitude in small-diameter drill holes in crystalline rocks and the permeability of fractures determined by packer-isolation tests. Thus, tube-wave amplitude logging has the potential for predicting the relative flow through fractures in hard rocks. The tube wave is part of the fluid wave propagated along the borehole wall under certain conditions; it apparently is attenuated where water in the borehole is free to move in and out of fractures. Figure 7-29 shows the correlation between a tube wave amplitude log calculated from digitized acoustic wave form data and fracture aperture or permeability from straddle packer tests (Davison, Keys, and Paillet 1982). Figure 7-27 is a composite log including shear and tube wave amplitude, temperature, single point resistance, and VDL. VDL indicates fractures as the low-velocity zones. The single point resistance is primarily controlled by the presence or absence of fractures. Natural flow in or out of the borehole through fractures affects the thermal gradient of the borehole fluid so that changes noted on the temperature log by arrows indicate natural fracture flow. The amplitude logs in Figure 7-27 were computed by calculating the root mean square amplitude within specified time windows. Two additional fracture zones evident on the VDL, and as low-amplitude excursions on the amplitude logs at 146-148 and 170 ft (44.5-45 and 52 m), are not obvious on the temperature log.

(16) Cement-bond logging. Cement-bond logging usually employs a single receiver to obtain information on the quality of the bond between casing and cement and between cement and borehole wall. Most cement-bond logs are a measurement only of the amplitude of the early arriving casing signal, but to improve the accuracy of interpretation, the full acoustic wave form is needed for study. Although a small amount of the total acoustic energy may be received from the rock when the casing is free to vibrate, the formation signal usually is not detectable. The detection of channeling through cement in the annular space is one of the main objectives of cement-bond logging; yet, even an expert in the analysis of cement-bond logs probably will not locate all channels accurately.

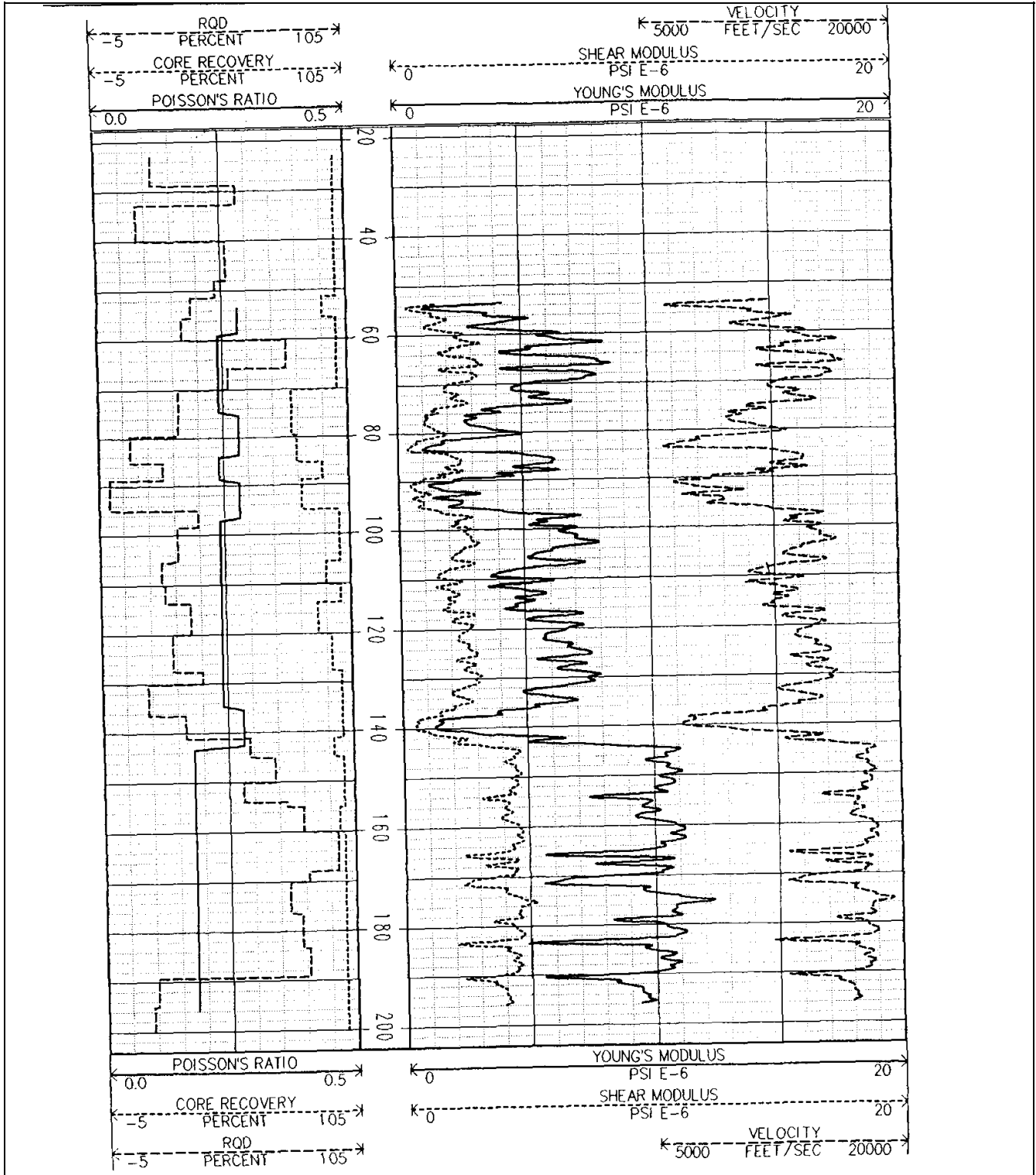

Figure 7-28. Engineering properties calculated from geophysical logs of a core hole compared with rock quality determination (RQD) from the core (Yearsley and Crowder 1990; copyright permission granted by Colog, Inc.)

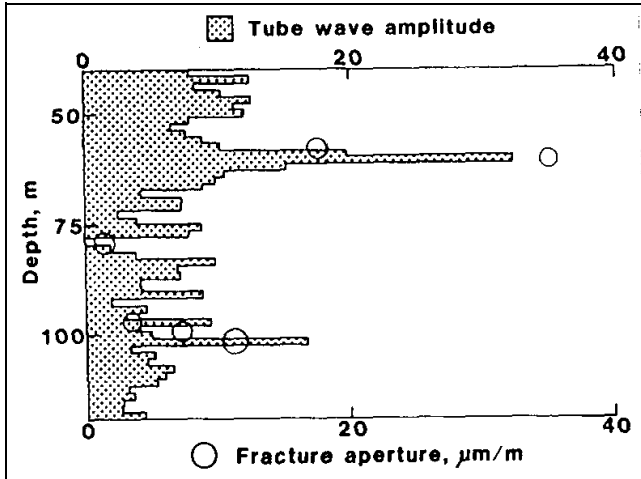

Figure 7-29. Plot showing a comparison of tube wave amplitude calculated from acoustic wave form data and hydraulic fracture aperture calculated from straddle packer tests

(17) Acoustic-televiwer logging.

(a) Principles. An acoustic televiwer (ATV) is a logging device that can provide high-resolution information on the location and character of secondary porosity, such as fractures and solution openings. It also can provide the strike and dip of planar features, such as fractures and bedding planes. An ATV also is called the borehole televiwer but this term occasionally causes it to be confused with borehole television. An ATV employs a rotating high-frequency transducer that functions as both transmitter and receiver (Zemanek et al. 1969). The piezoelectric transducer is rotated at three or more revolutions per second and is pulsed approximately 1,200 times per second. High-frequency acoustic energy is reflected from, but does not penetrate, the borehole wall. A trigger pulse is transmitted to the surface equipment from a flux-gate magnetometer each time the transducer rotates past magnetic north. This pulse triggers the sweep of an oscilloscope or graphic recorder, so that each sweep represents a 360-deg scan of the borehole wall. The brightness of the oscilloscope trace is proportional to the amplitude of the reflected acoustic signal, somewhat analogous to a rotating depth finder in a boat.

(b) Procedure. The probe must be centralized accurately with bow springs, so the signal path will be the same length in all directions. As the probe moves up the hole, a signal is generated that moves the sweeps across the oscilloscope or other type of graphic recorder to produce a continuous record of the acoustic reflectivity of the

borehole wall. The received signal may also be recorded in analog format on standard VHS tape for later playback and enhancement of the graphic record. The signal from the ATV probe may be digitized in new generation probes or subsequently from the VHS analog tape from older systems. The digital data file may then be enhanced, analyzed, and displayed in various color formats using a computer program. This program, and similar programs developed by logging companies, produces three-dimensional plots, calculates the aperture and strike and dip of fractures, the orientation of breakouts, borehole diameter, acoustic reflectivity, stress field, etc. The ATV log is a cylinder that has been opened along the north side and flattened, as illustrated in Figure 7-30. In this figure, an open fracture dipping to magnetic south is shown intersecting a drill hole in a three-dimensional drawing on the left. The hypothetical televiwer log on the right shows the fracture as it might appear, as a dark sinusoid, with the low point oriented toward magnetic south. The transducer rotates clockwise, as viewed looking down the well; hence, compass directions are in the order shown at the bottom of the log. Fractures and other openings in the borehole wall or in casing appear as dark areas for several reasons. Increasing well diameter means the acoustic signal must travel farther, and that it will be more attenuated by the fluid in the borehole. In addition, part of the surface of fractures and other openings is not at right angles to the incident acoustic signal, so that it is not reflected back to the transducer.

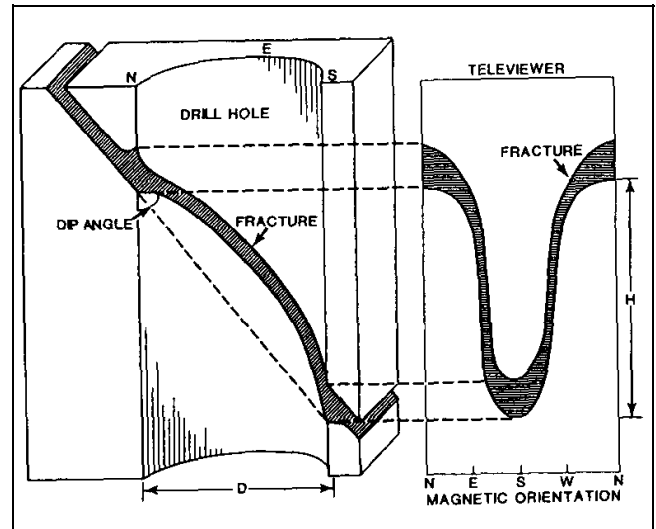

Figure 7-30. Three-dimensional view of a fracture and appearance of the same fracture on an acoustic-televiwer log. D is borehole diameter and h is the length of the fracture intercept in the borehole

(c) Acoustic-caliper log. Modifications to ATV equipment permit recording an acoustic-caliper log, which consists of four high-resolution traces. Use of a lower frequency transducer provides better penetration of casing, and the tool can be used to examine cement in the annular space. Broding (1984) demonstrated the ability of a lower frequency probe to locate voids and channels in cement that were not detected by other logging methods. Acoustic televiewer logs, made in steel casing or in the presence of large concentrations of magnetic minerals, are not oriented, because the magnetometer will not work under these conditions. A switch in the tool can be used for triggering the sweep instead of the magnetometer; as a result, compass orientation of the edge of the log will rotate as the tool is brought up the hole.

(d) Quantitative output. Two quantitative outputs of the acoustic televiewer occur that may require calibration and occasional standardization onsite. The magnetometer needs to be checked with a compass to determine if it triggers on magnetic north within a degree, if possible; this can be accomplished by using a narrow reflective object in a plastic bucket filled with water. The lower set of centralizers usually are removed for this procedure. If an acoustic-caliper log is to be run, hole-diameter response needs to be checked.

(e) Volume of investigation. The concept of volume of investigation does not apply to the televiewer in a strict sense because, with the typical high-frequency transducer, most of the signal is received from the wall of the borehole. Even if the frequency is reduced to half the usual value, rock penetration is small. However, acoustic-televiewer probes have mechanical and electronic limits to the diameter of the well that can be logged. The operating range of borehole diameter for most tools is from 76 to 400 mm (3 to 16 in.).

(f) Interpretation. An acoustic televiewer provides a record of the location, character, and orientation of any features in the casing or borehole wall that alter the reflectivity of the acoustic signal. These include diameter and shape of the drill hole, wall roughness that may be caused by drilling procedures or lithology, differences in rock hardness, and structural features like bedding, fractures, and solution openings. The smallest feature that can be resolved on an ATV log depends on a number of factors; among them are hole diameter and wall roughness. Under the right conditions, features as small as 1 mm, or possibly even smaller, can be identified. Figure 7-31 is a comparison of fractures detected by borehole television, detailed core description, and by the acoustic televiewer at a reactor site in Canada (Davison, Keys, and

Paillet 1982). The first two are diagrammatic reconstructions of the fractures, and the ATV log is a copy of the field log. The ATV shows all of the open fractures that are likely to be capable of transmitting water. Borehole television or video missed some of these fractures and some of the fractures shown as dashed on the core log are actually only visible with a hand lens. Paillet (1994) discusses the televiewer and other techniques used to characterize flow in fractured rocks.

(g) Applications. A televiewer log of a fracture-producing zone in a geothermal well at Roosevelt Hot Springs, Utah, is shown in Figure 7-32. Acoustic- and mechanical-caliper logs of this zone are shown in Figure 7-33. These logs were made at temperatures as high as 260°C (Keys 1979). The fracture-producing interval shown in Figure 7-32 is approximately 1.2 m thick; it apparently is the result of alteration and solution, along a series of subparallel fractures, seen as black sinusoids in the figure. The fracture at the top of the interval appears to be about 150 mm (6 in.) wide, based on the log; it is probably much less. Fractures tend to be broken out during drilling, and the broken edges further increase the apparent thickness on the log by refracting the acoustic signal. This is particularly evident at the top and bottom of the sinusoid on steeply dipping fractures, as illustrated in Figure 7-30. The open fracture in the fracture-producing zone is paralleled by one relatively tight fracture above, and probably six fractures below, which produced a brecciated, and probably altered, permeable zone. The effect of drilling technique and lithology on the interpretation of fracture character from ATV logs is discussed by Paillet, Keys, and Hess (1985). Log quality generally is not as good where the wall of the hole is rough, or where rocks are soft.

(h) Strike and dip. To calculate the strike and dip of fractures or bedding, the following information is needed: the vertical intercept distance on the ATV log  $H$  as shown in Figure 7-30; the direction of dip from the ATV log; and, the hole diameter  $D$  from a caliper log. The same measuring units must be used for  $H$  and  $D$ . The angle of dip, in degrees, is equal to the arc tangent of  $H/D$ . If the average  $H$  for the fractures in Figure 7-30 is 12 in. and the hole diameter is 6 in., the dip would be 63 deg; if the hole diameter is 12 in., the dip would be 45 deg. Direction of dip usually can be measured to the nearest 5 deg, using a 360-deg scale constructed to fit the width of the ATV log. The average direction of dip of the fractures in Figure 7-32 is slightly south of west.

(i) Orientation of stress field. Orientation of the stress field may be determined from an analysis of ATV

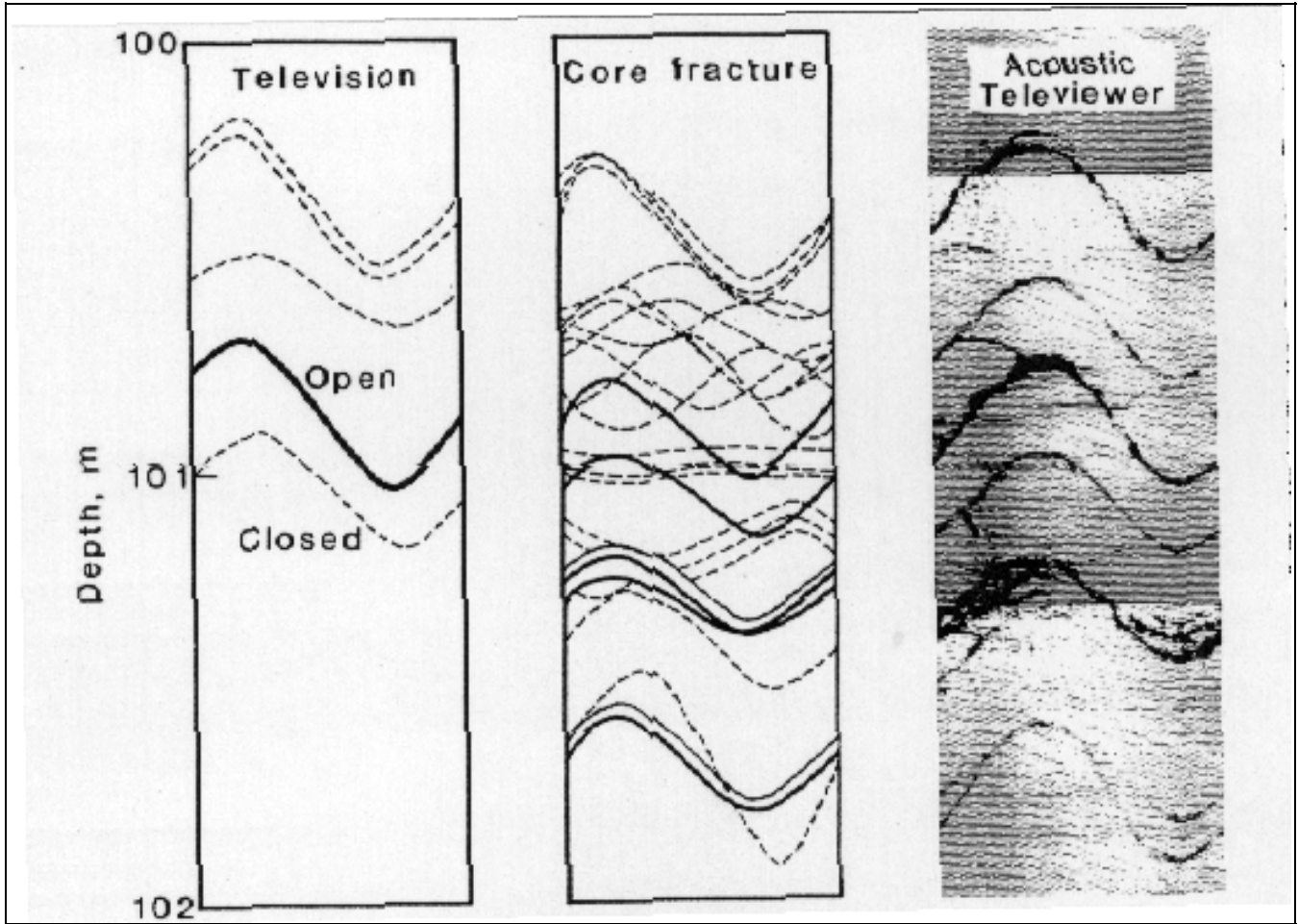

Figure 7-31. Diagram showing comparison of reconstructed fracture data from borehole television, and a detailed core log, with a copy of an acoustic televiewer log

logs made in wells where fractures have been induced hydraulically, either intentionally or accidentally, by drilling (Wolff et al. 1974, Keys et al. 1979). Hydraulic fractures are oriented perpendicular to the direction of least principal stress. Hydraulic fractures accidentally induced during drilling may provide permeable pathways for waste migration at environmental sites. Breakouts are increases in borehole diameter oriented at right angles to the maximum, principal, horizontal stress. They are easily recognized on ATV logs and have been discussed in detail by Paillet and Kim (1985). Breakouts appear as two vertical dark bands with irregular margins located approximately 180 deg apart on the log.

(j) Additional applications. The acoustic televiewer can also be used to examine casing for holes and to locate joints in pipe and well screens; borehole television might be better for these purposes if the water is clear and the

walls are clean. Above the water level, television needs to be used because the ATV will not operate.

(k) Extraneous effects. Interpretation of televiewer logs is complicated by a number of extraneous effects. Most significant are poor centralization, incorrect gain settings, errors from borehole deviation, and aberrations in the magnetic field. Significant deviation from vertical is common in deep drill holes, which introduces several errors on ATV logs. In addition to the obvious error in the measured vertical depth, corrections must be made to dip and strike calculated from ATV logs in deviated holes. Boreholes are not usually round, and this produces vertical black bands on ATV logs. Poor tool centralization in deviated wells produces similar features on the logs. Choosing the proper gain setting for the tool is a matter of operator experience and is quite important in producing high quality logs.



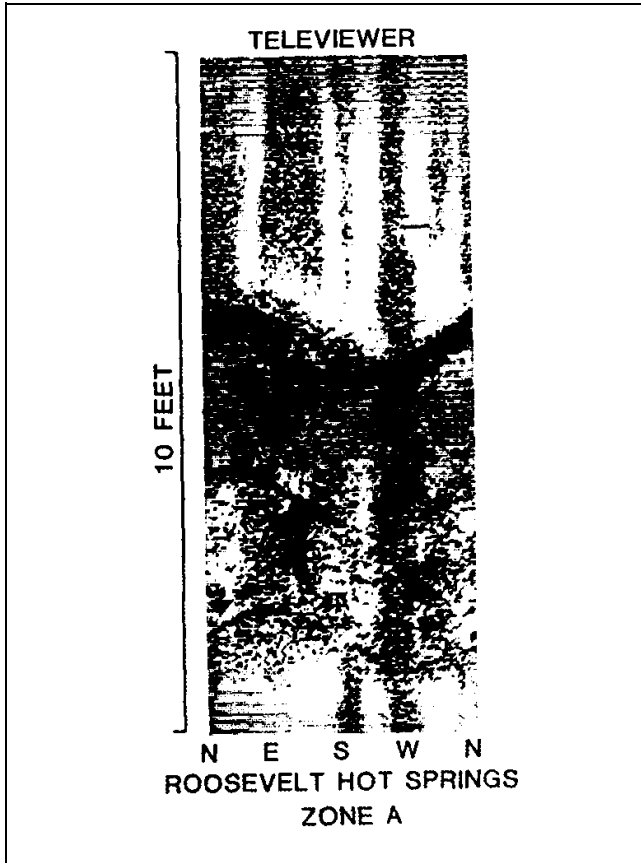

Figure 7-32. Acoustic-televIEWER log of fracture-producing zone A in a geothermal well, Roosevelt Hot Springs, Utah

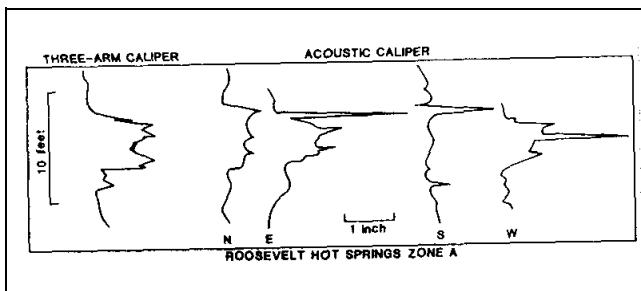

Figure 7-33. Mechanical- and acoustic-caliper logs of fracture-producing zone A in a geothermal well, Roosevelt Hot Springs, Utah

(18) Caliper logging.

(a) Principles. Caliper logs provide a continuous record of borehole diameter and are used widely for groundwater applications. Changes in borehole diameter may be related to both drilling technique and lithology.

Caliper logs are essential to guide the interpretation of other logs, because most of them are affected by changes in well diameter. They also are useful in providing information on well construction, lithology, and secondary porosity, such as fractures and solution openings. Many different types of caliper probes are described in detail by Hilchie (1968). The most common type of probe used for logging water wells has three arms approximately the diameter of a pencil, spaced 120 deg apart. Arms of different lengths can be attached to this type of tool to optimize sensitivity over the hole-diameter range expected. Mechanical caliper probes have been used that will measure to a maximum hole diameter of 1 m (42 in.). The typical water-well caliper employs arms that are connected to move a linear potentiometer; so changes in resistance, transmitted to the surface as voltage changes, are proportional to average hole diameter. Single-arm calipers commonly are used to provide a record of hole diameter while running another type of log. The single arm also may be used to decentralize a probe, such as a side-collimated gamma-gamma tool, but logs made with this type of probe are usually not high resolution. High-resolution caliper-logging devices usually employ three or four independent arms, and they are compass oriented in some tools. The difference in resolution between logs made with a four-arm device and the more common types is shown in Figure 7-34. The high-resolution logs on the left were made with four independent arms. The three-arm averaging tool is typical of that used in engineering and environmental applications, and the single arm log on the right was recorded during the running of a compensated gamma-gamma log. The apparent erratic response on the four-arm caliper logs in part of the well is repeatable and is caused by solution openings in the carbonate rock. Digital sample interval should be close spaced, such as 0.03 m (0.1 ft), if high-resolution logs are desired. Acoustic calipers may use the time-of-travel data from an acoustic televIEWER to provide compass-oriented, high-resolution traces.

(b) Calibration. Calibration of calipers is carried out most accurately in cylinders of different diameters. Large cylinders occupy a considerable amount of room in a logging truck, so it is common practice to use a metal plate for onsite standardization of three-arm averaging or single-arm probes. The plate is drilled and marked every inch or two and machined to fit over the body of the probe and accept one caliper arm in the holes. Because values obtained with a calibration plate are not as accurate as those obtained with a cylinder, usually log scale is checked using casing of known diameter in the well.

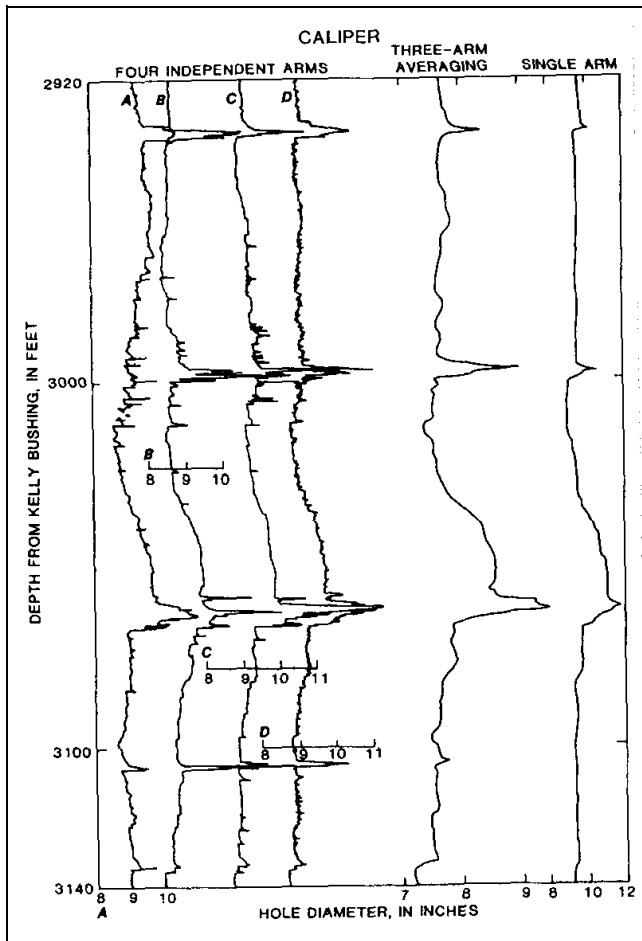

**Figure 7-34. Caliper logs from probes having four independent arms, three averaging arms, and a single arm, Madison limestone test well No. 1, Wyoming**

(c) Interpretation. A valid caliper log is essential to guide the interpretation of the many different types of logs that are affected by changes in hole diameter, even those that are labeled borehole compensated. Differences in hole diameter are related to drilling technique and lithology and structure of the rocks penetrated. The shallower part of a hole is usually larger diameter than the deeper part, because it has been exposed to more drilling activities. Couplings, welds, and screens may be located on a high-resolution caliper log.

(d) Applications. Caliper logs have been used to correlate major producing aquifers in the Snake River Plain in Idaho (Jones 1961). Vesicular and scoriaceous tops of basalt flows, cinder beds, and caving sediments were identified with three-arm caliper logs. In the Snake River, basalt caliper logs also were used to locate the optimum depth for cementing monitoring wells and to

estimate the volume of cement that might be required to achieve fill of the annulus to a preselected depth (Keys 1963). Similarly, a caliper log can be used to calculate the volume of gravel pack needed and to determine the size of casing that can be set to a selected depth. Caliper logs are particularly useful for selecting the depths for inflating packers. Packers can be set only over a narrow specified range of hole diameters and may be damaged if they are set in rough or irregular parts of a well. Packers set under these conditions may explode; if they are set on a fracture, they may implode or be bypassed by flow. Caliper logs are useful for determining what other logs can be run and what range of diameters will be accepted by centralizers or decentralizers. Hole-diameter information is essential for the calculation of volumetric rate from many types of flowmeter logs. Because of the usefulness of a caliper log to the interpretation of other logs, it needs to be run before casing is installed in a hole that is in danger of caving. When hole conditions are questionable, the first log run is usually the single-point resistance log, because it will provide some lithologic information; if it is lost, the tool is relatively inexpensive to replace. If no serious caving problems are detected during the single-point log, a caliper log needs to be run before casing is installed so it can be used to aid the analysis of nuclear logs made through the casing. Very rough intervals of a drill hole, with changes in hole diameter of several inches, cannot be corrected based on caliper logs, and they need to be eliminated from quantitative analysis.

(e) Lithology and secondary porosity. Caliper logs can provide information on lithology and secondary porosity. Hard rocks like limestone will show on the log as a smaller diameter than adjacent shales. Shales may produce an irregular caliper trace, caused by thin bedding. See Figure 7-8 for an example of this response. Secondary porosity, such as fractures and solution openings, may be obvious on a caliper log, although the character will not be uniquely defined as it would be on an acoustic-televueer log. Four traces from an acoustic-caliper log and a mechanical-caliper log for a fracture-producing zone in a geothermal well at Roosevelt Hot Springs, Utah, are included in Figure 7-33. The oriented traces of the acoustic caliper clearly show the apparent openness of the fractures and the direction of dip of the larger fracture at the top of the zone. These traces also demonstrate that the drill hole is not symmetrical or round, which is a typical condition. Open fractures are detected readily by three-arm averaging calipers but the true character of the fractures may not be correctly interpreted from a caliper log. If an open fracture is dipping at a sufficient angle so that the three arms enter the opening at different depths,

the separate anomalies produced will indicate three fractures rather than one.

(19) Fluid logging. Fluid logging includes those techniques that measure characteristics of the fluid column in the well; no direct signal is derived from the surrounding rocks and their contained fluids. The fluid logs that are described here are temperature, electrical conductivity, and flow. Fluid logs are unique in that the recorded characteristics of the fluid column may change rapidly with time and may be altered by the logging process.

(20) Temperature logging.

(a) Principles. Temperature probes used in groundwater and environmental studies employ a glass-bead thermistor, solid-state IC device or platinum sensor mounted in a tube that is open at both ends to protect it from damage and to channel water flow past the sensor. The sensor may be enclosed in a protective cover, but it must be made of materials with a high thermal conductivity and small mass to permit fast response time. Thermistor probes used by the U.S. Geological Survey have an accuracy, repeatability, and sensitivity on the order of 0.02°C. They also are very stable over long periods of time, but they have the disadvantage of a nonlinear temperature response. For high-temperature logging in geothermal wells, platinum sensors may be used that have an accurate, stable, and linear response. Two general types of temperature logs are in common use: the standard log is a record of temperature versus depth; and the differential-temperature log is a record of the rate of change in temperature versus depth. The differential-temperature log can afford greater sensitivity in locating changes in gradient. The differential-temperature log can be considered to be the first derivative of the temperature; it can be obtained with a probe with two sensors located from 0.3 to 1.0 m apart or by computer calculation from a temperature log. A differential log has no scale and log deflections indicate changes from a reference gradient.

(b) Calibration. Calibration of temperature probes needs to be carried out in a constant temperature bath, using highly accurate mercury thermometers. The bath and probe need to reach equilibrium before a calibration value is established. Onsite standardization cannot be carried out with great accuracy because no portable substitute exists for a constant-temperature bath. The only temperature that can be achieved and maintained for sufficient time to permit a valid calibration is 0°C, in an ice bath.

(c) Interpretation. Temperature logs can provide very useful information on the movement of water through a well, including the location of depth intervals that produce or accept water; thus, they provide information related to permeability. Temperature logs can be used to trace the movement of injected water or waste and to locate cement behind casing. Although the temperature sensor only responds to water or air in the immediate vicinity, recorded temperatures may indicate the temperatures of adjacent rocks and their contained fluids if no flow exists in the well.

(d) Applications. Temperature logs can aid in the solution of a number of groundwater problems if they are properly run under suitable conditions and if interpretation is not oversimplified. If there is no flow in, or adjacent to, a well, the temperature gradually will increase with depth, as a function of the geothermal gradient. Typical geothermal gradients range between 0.47 and 0.6°C per 30 m of depth; they are related to the thermal conductivity or resistivity of the rocks adjacent to the borehole and the heat flow from below. The geothermal gradient may be steeper in rocks with low intrinsic permeability than in rocks with high intrinsic permeability.

(e) Thermal gradient. The sensor in a temperature probe only responds to the fluid in its immediate vicinity. Therefore, in a flowing interval, measured temperature may be different from the temperature in adjacent rocks. Under these conditions, a thermal gradient will exist from the well outward. Only in a well where no flow has occurred for sufficient time to permit thermal equilibrium to be established, does a temperature log reflect the geothermal gradient in the rocks. If vertical flow occurs in a well at a high rate, the temperature log through that interval will show little change. Vertical flow, up or down, is very common in wells that are completed through several aquifers or fractures that have different hydraulic head, although the flow rate is seldom high enough to produce an isothermal log. Movement of a logging probe disturbs the thermal profile in the fluid column. Unless rapid flow is occurring, each temperature log will be different. High-logging speed and large-diameter probes will cause the greatest disturbance. The most accurate temperature log is made before any other log, and it is recorded while moving slowly down the hole. Convection is a major problem in the interpretation of temperature logs, particularly in large-diameter wells and in areas of high-thermal gradient. Convective cells in large-diameter wells can cause major temperature anomalies unrelated to groundwater movement (Krige 1939).

(f) Example. Identification of fractures producing groundwater from Triassic sedimentary rocks is illustrated in Figure 7-35. The temperature log on the left shows several changes in gradient that are clearly defined by the computer-derived differential-temperature log. The caliper log suggests that water production may come from fractures; this interpretation is substantiated by the acoustic-televiwer logs, on the right.

(g) Additional applications. Temperature logs can be used to trace the movement of injected water (Keys and Brown 1978). A sampling of several hundred temperature logs run during a 7-day recharge test in the high plains of Texas is shown in Figure 7-36. Water from a playa lake was injected into an irrigation well, and logging was used to determine the movement of the recharge water and the extent of plugging of the Ogallala aquifer. Several monitoring holes were drilled and completed with 2-in. steel pipe, capped on the bottom and filled with water. The logs in Figure 7-36 were of a monitoring hole located 12 m from the injection well. Most of the time, the water in the playa lake was warmer than the groundwater, and the lake temperature fluctuated several degrees each day. The passing of a cold front caused a marked decrease in temperature of the lake water. The first warm water was

detected in the monitoring hole less than 4 hr after recharge started. The temperature logs indicated that the interval of highest permeability was located at a depth of approximately 50 m (160 ft). Water did not arrive at a depth of 55 m (180 ft) until the third day. Diurnal temperature fluctuations and buildup of a recharge cone can be observed in Figure 7-36. Data plotted in Figure 7-37 were calculated from temperature logs of the same borehole; however, logs from other holes gave similar results. The solid line in the upper half of Figure 7-37 shows the diurnal-temperature fluctuations of the recharge water obtained from a continuous recorder on the recharge line. The other three lines represent fluctuations at three depths in the monitoring well, as obtained from temperature logs. The points shown by symbols represent the calculated center of the thermal waves. Travel times of the centers of the waves did not decrease during the life of the test, except possibly at the end. Test results show that the aquifer was not plugged by recharging water with a high content of suspended solids and entrained air, and the well yield was greatly increased. Temperature logs can be used to trace the movement of water that has been injected from a tank that has been allowed to heat in the sun. In a similar fashion, temperature logs can be used to locate plumes of wastewater that result from injection in

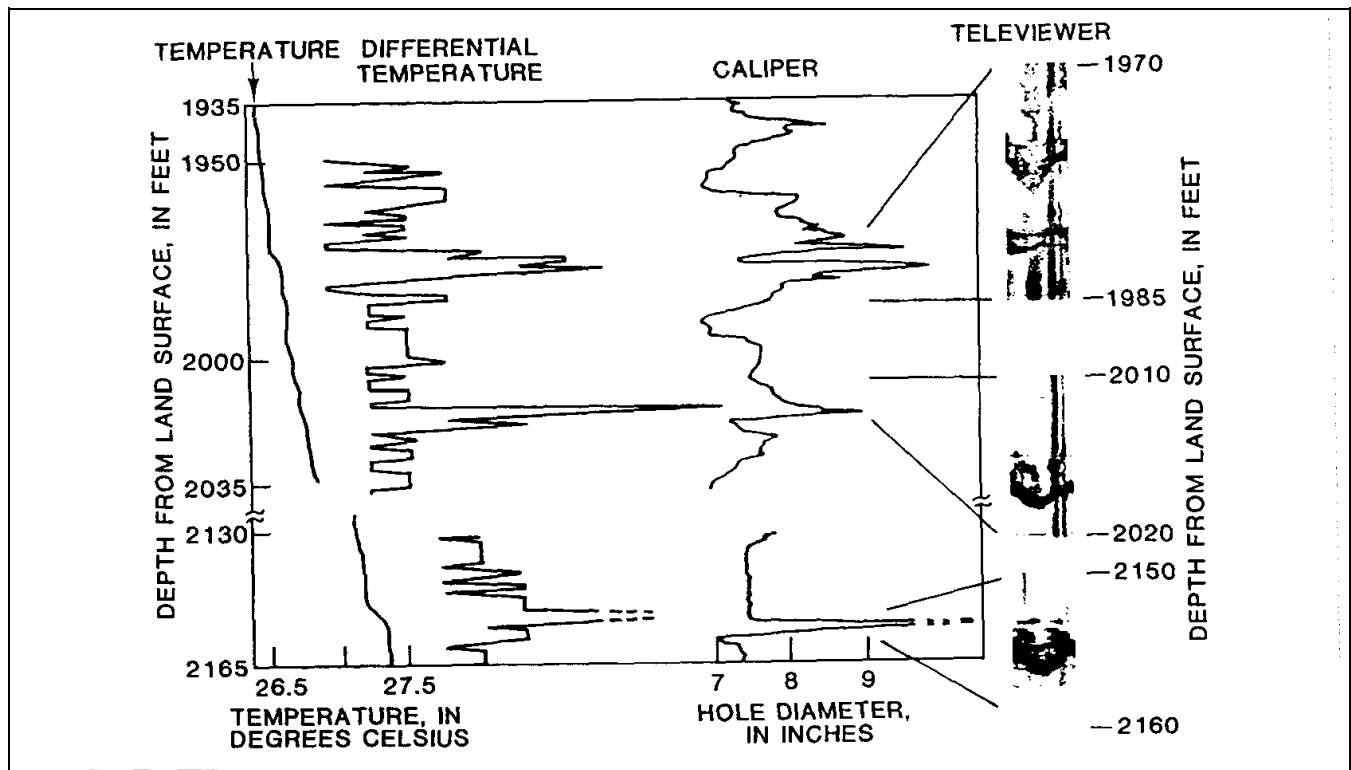

Figure 7-35. Temperature, differential-temperature, caliper, and acoustic-televiwer logs of Sears test well No. 1, near Raleigh, NC

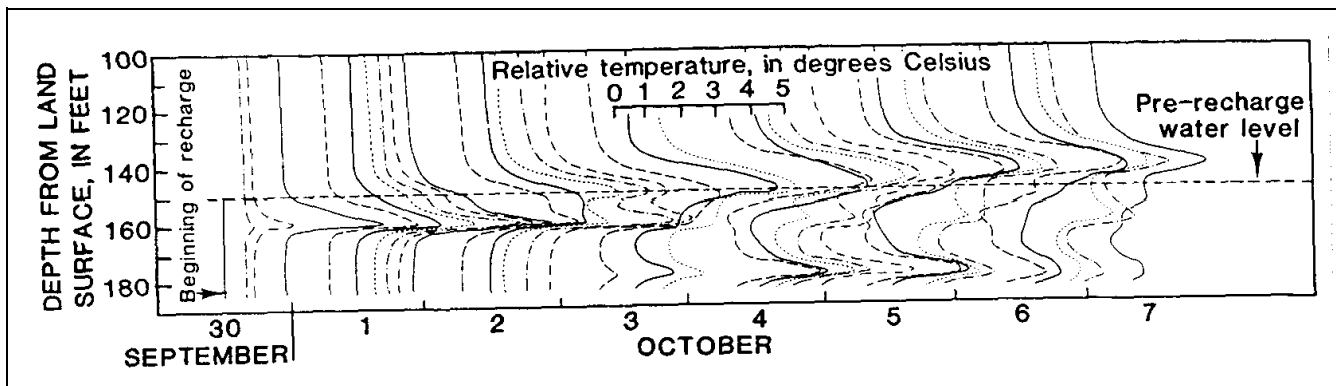

Figure 7-36. Selected temperature logs of a monitoring hole 39 ft from a recharge well, high plains of Texas

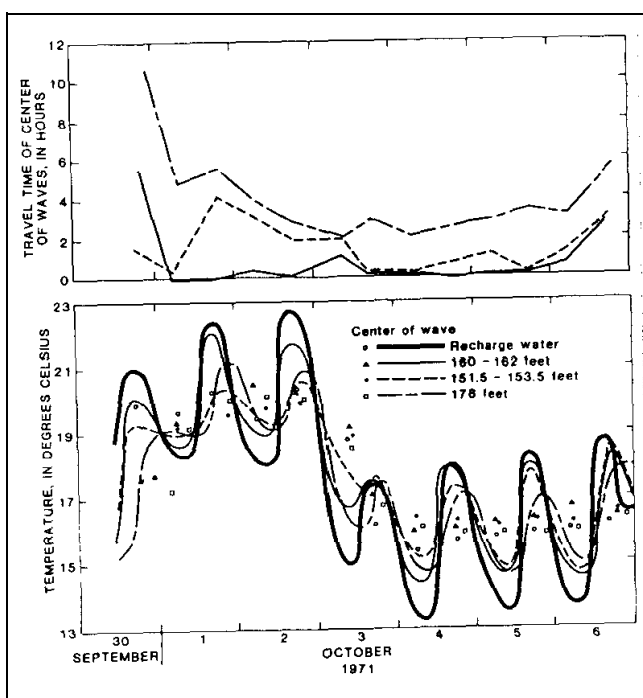

Figure 7-37. Diurnal-temperature cycles and travel times, based on temperature logs of a monitoring hole 39 ft from a recharge well

wells or seepage from ponds, if the wastewater temperature is sufficiently different from the groundwater. Temperature logs also can be used to determine the location of cement grout outside of casing. The casing is filled with water, and the log usually is run within 24 hr of grout injection; however, anomalous temperatures may persist for several days.

(21) Conductivity logging.

(a) Principles. Logs of fluid electrical conductivity, which is the reciprocal of fluid resistivity, provide data

related to the concentration of dissolved solids in the fluid column. Although the fluid column may not reflect the quality of adjacent interstitial fluids, the information can be useful when combined with other logs. Fluid-conductivity or resistivity logs are records of the capacity of the borehole fluid that enters the probe to transmit electrical current. The probe should not be affected by changes in the conductivity of adjacent fluids or solid materials because it is constructed with the electrodes inside a housing. Ring electrodes are installed on the inside of a steel tube that is open at both ends, so water will flow through as the probe moves down the well. The electrodes are usually gold or silver to reduce changes in contact resistance caused by chemical reactions, and they are insulated from the steel housing. Conductivity is recorded in  $\mu\text{mho/cm}$  or  $\mu\text{S/cm}$ , which is equal to 10,000 divided by the resistivity in  $\Omega\text{m}$ . Both units are used for fluid logging, and they can be converted to standard temperature by use of Figure 7-11 or a similar chart. Specific conductance is measured at the standard temperature of 25°C. Calibration usually is done empirically in solutions of known sodium chloride concentration, because most charts are based on this salt, and conversion factors are available to correct for the presence of other ions. The salinity of the calibration solution may be calculated by adding a known amount of salt to distilled water and converting to conductivity, or by measuring with an accurate laboratory conductivity meter. Temperature of the calibration solution is recorded while the measurement is being made, and it needs to be uniform and stable. Onsite standardization may be carried out using several fluids of known concentration in plastic bottles sufficiently large to allow submersion of all electrodes in the probe. A laboratory conductivity cell or a less accurate mud resistivity kit also can be used. Disturbance of the fluid column in the borehole can make fluid-conductivity logs difficult to interpret. Disturbance of an equilibrium-salinity profile can be caused by the movement of logging

probes or by convective flow cells. Because of the possibility of disturbance by logging, the most accurate fluid-conductivity log is made on the first trip down the well. This recommendation also pertains to temperature logs, so an ideal probe is capable of making simultaneous fluid-conductivity and temperature logs.

(b) Interpretation. The interpretation of fluid-conductivity logs is complicated by the flow regime in a well. Unless the flow system is understood, analysis of the conductivity profile is subject to considerable error. Information on the construction of the well, flowmeter logs, and temperature logs are useful in the interpretation of conductivity logs. When both fluid conductivity and temperature are known, the sodium chloride concentration can be determined from Figure 7-11. Water samples must be analyzed to determine the concentrations of the various ions so corrections can be made.

(c) Applications. Regional patterns of groundwater flow and recharge areas may be recognized from fluid-conductivity logs of the wells in an area. Fluid-conductivity data can be used to map and monitor areas of saltwater encroachment. Similarly, the logs can be used to monitor plumes of contaminated groundwater from waste-disposal operations. Commonly, chemical waste or leachate from solid-waste-disposal operations produces groundwater with a higher than normal conductivity. Conductivity logs provide the basis for selecting depths from which to collect water samples for chemical analyses. Fluid-conductivity logging equipment can be used to trace the movement of groundwater by injecting saline water or deionized water as a tracer. Small amounts of saline water may be injected at selected depths, and conductivity logs may be used to measure vertical flow in a single well, or larger amounts may be detected in nearby wells. Another important use for fluid-conductivity logs is to aid in the interpretation of electric logs. Spontaneous potential, single-point resistance, and many types of multi-electrode-resistivity logs are affected by the salinity of the fluid in the well.

## (22) Flow logging.

(a) Principles. The measurement of flow within and between wells is one of the most useful well-logging methods available to interpret the movement of groundwater and contaminants. Flow measurement with logging probes includes mechanical methods, such as impellers, chemical and radioactive tracer methods, and thermal methods (Crowder, Paillet, and Hess 1994). Their primary application is to measure vertical flow within a single well, but lateral flow through a single well or flow

between wells also may be recorded by borehole-geophysical methods.

(b) Impeller flowmeter. The most common logging probe used at the present time for measuring vertical fluid movement in water wells is the impeller flowmeter, which is a relatively inexpensive and reliable instrument. Most impeller flowmeters incorporate a lightweight three- or four-bladed impeller that rotates a magnet mounted on the same shaft. The magnet actuates a sealed microswitch, so that one or more pulses are impressed on low-voltage direct current that is connected across the switch. The impeller is protected from damage by a basket or housing, and the probe is centralized with bow springs, or similar devices, for best results. Baskets and impellers of different diameters are available and are easily changed, so the maximum size for a well can be used to increase sensitivity. Continuous logs of flow rate may be made at a constant logging speed and supplemented by more accurate stationary measurements at selected depths. The main shortcoming of impeller-type flowmeters is the lack of sensitivity to low-velocity flow. The most commonly used impeller flowmeters usually stall at vertical velocities of 1.2 to 1.5 m/min (4 to 5 ft/min), although it is possible to measure velocities as low as one half those velocities under some conditions. The addition of a packer or other flange-like device to divert most of the flow through the basket will improve sensitivity to low velocity, particularly in large-diameter wells.

(c) Tracer techniques. Tracer methods have been used in groundwater for many years, but only those that employ logging equipment are described here. Tracer techniques are useful at much lower velocities than impeller flowmeters; rates of about 1 m/day may be detected. The most commonly employed methods use a probe to follow the vertical movement of a chemical or radioactive tracer injected at selected depths in a well. An extension of this method may permit the detection of arrival of the tracer by logging adjacent wells. Radioactive tracers can be detected at lower concentrations than chemical tracers; most of them can be detected through casing. The difficulties in obtaining the permits necessary for using radioactive tracers has restricted their application. Temperature and fluid conductivity logs can also be used to measure flow rates between wells.

(d) Heat-pulse flowmeters. A heat-pulse flowmeter originally was developed in England (Dudgeon, Green, and Smedmor 1975). Its design was modified extensively, and a new probe was built by A. E. Hess of the U.S. Geological Survey (Hess 1982). The modified version works reliably and has been used in wells to measure

very low velocities, as described in paragraph 7-1j(22)(g) "Interpretation and Applications." The logging system is shown schematically in Figure 7-38, modified from Hess (1982). The wire heat grid, located between two thermistors, is heated by a 1-ms pulse of electric current which is triggered from the surface. The heated sheet of water moves toward one of the thermistors under the influence of the vertical component of flow in the well. The arrival of the heat pulse is plotted on a chart recorder running on time drive, as illustrated in Figure 7-39. A deflection of the recorder trace to the right indicates upward flow, and to the left, downward flow. The system is calibrated in flow columns of various sizes for flow in each direction, because the tendency for heated water to rise and the asymmetry of the probe produce slightly different calibration curves in the two directions. The USGS heat-pulse flowmeter can be used to measure vertical-water velocities from 30 mm/min or less to 12 m/min or greater (0.1 to 40 ft/min), and it has advantages over both impeller flowmeters and tracer logging. An inflatable packer or flexible diverter can be attached to a flowmeter to force all flow through the probe and, thus, improve the performance of the heat-pulse flowmeter. A similar heat pulse flowmeter is now available commercially. A number of techniques have been tried for measuring horizontal flow in wells without much success or wide use. The technique may not provide an accurate estimate of average direction and velocity of flow in the aquifer, because of the perturbations in the flow system caused by the well. A heat-pulse logging system has been developed for measuring horizontal flow (Kerfoot 1982); it employs a series of paired thermistors located circumferentially

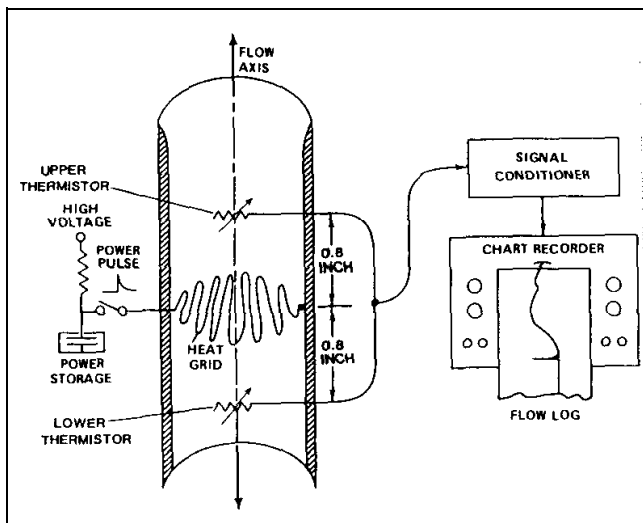

Figure 7-38. Equipment for making heat-pulse flowmeter logs (Hess 1982)

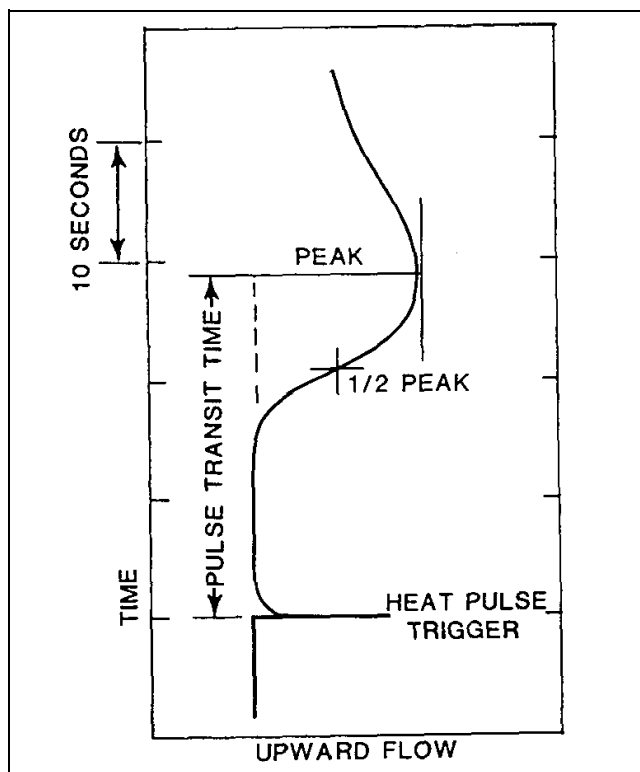

Figure 7-39. Analog record of a heat pulse from a thermal flowmeter (Hess 1982)

around a heat emitter, and it is based on thermal transmission through an enclosing porous matrix of glass beads.

(e) Calibration. Calibration of flow-measuring probes is done best in laboratory facilities designed for this purpose. Subsequent calibration checks and standardization may be carried out in a well under the proper conditions. The U.S. Geological Survey has designed and built a facility that is used for calibrating their flow-measuring probes (Hess 1982). The test facility consists of clear plastic columns with inside diameters of 2, 4, and 6 in. connected to a pump that can circulate water in either direction, at velocities from 21 mm to 15 m/min (0.07 to 50 ft/min), depending on column size. Onsite standardization or calibration can be performed by moving the flowmeter up or down a cased portion of a well at carefully controlled logging speeds. Calibration by this method is only valid at the casing diameter logged. An example of this type of calibration is shown in Figure 7-40, where the pulses per unit time are plotted against the logging speed. The two lines with different slopes represent opposite directions of impeller rotation. The range of tool speeds near this intersection represents the stall zone where the velocity is too low to turn the

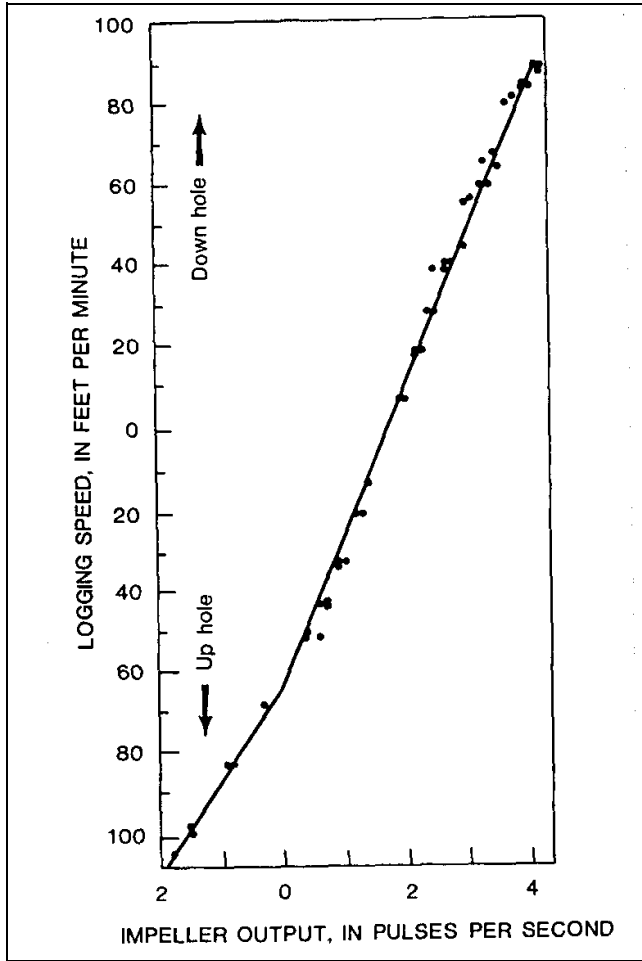

Figure 7-40. Calibration data for an impeller flowmeter, developed by moving the probe in a well

impeller. Theoretically, this intersection represents the velocity at which water was flowing up the well.

(f) Hydrophysical logging. Fluid replacement and fluid-column conductivity logging, known by the trade name "Hydrophysical" logging (Pedler et al. 1990; Pedler, Head, and Williams 1992; Tsang, Hufschmied, and Hale 1990) involves fluid column conductivity logging over time after the fluid column has been diluted or replaced with environmentally safe deionized water. Hydrophysical logging results are independent of borehole diameter and the method does not require a flow concentrating diverter or packer. The logging probe involves relatively simple and readily available technology and has a small diameter allowing it to be run through an access pipe below a pump. Hydrophysical logging is used to determine flow magnitude and direction during pumping and under ambient conditions, and to identify hydraulically conductive intervals to within one wellbore diameter.

Figure 7-41 is a schematic drawing of the equipment used to replace the borehole fluid with deionized water and to subsequently run a series of fluid conductivity logs to record the inflow of formation fluids.

(g) Interpretation and applications. Interpretation of flowmeter logs is simple if the probe has been properly calibrated and if all the essential information on hole diameter and construction is available. Vertical flow is common in most wells that are open to more than one aquifer and flow can be induced by pumping or injecting water. The heat-pulse flowmeter developed by Hess (1982) was used first in the field to identify fractures producing and accepting water in granitic rocks (Keys 1984). A caliper log and data from the heat-pulse flowmeter are shown in Figure 7-42. Data from the heat-pulse

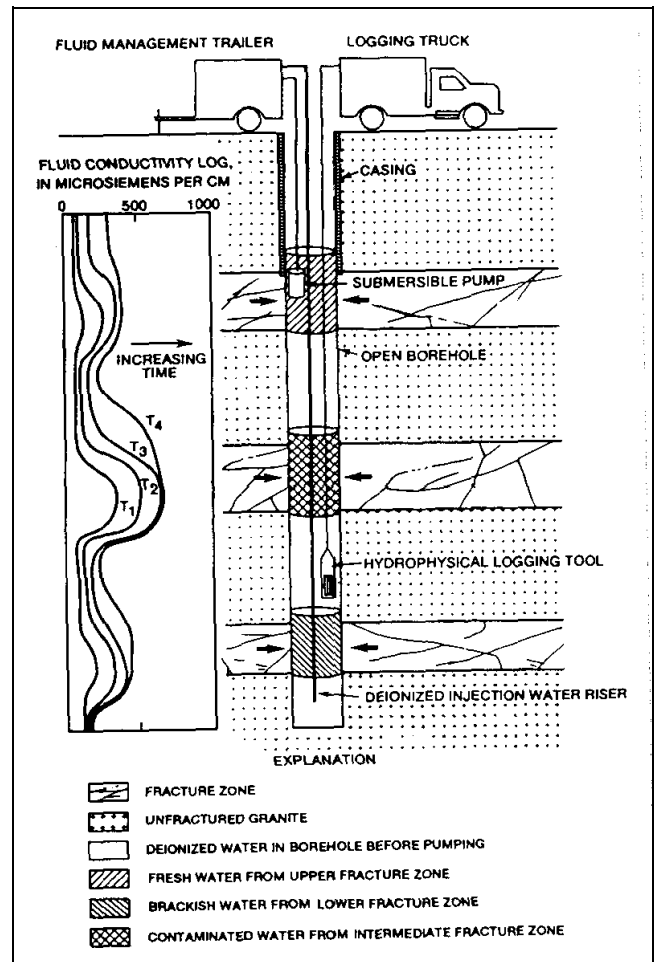

Figure 7-41. Schematic drawing of equipment used for hydrophysical logging after injection of deionized water; and time series of fluid conductivity logs (Vernon et al. 1993; copyright permission granted by Colog, Inc.)



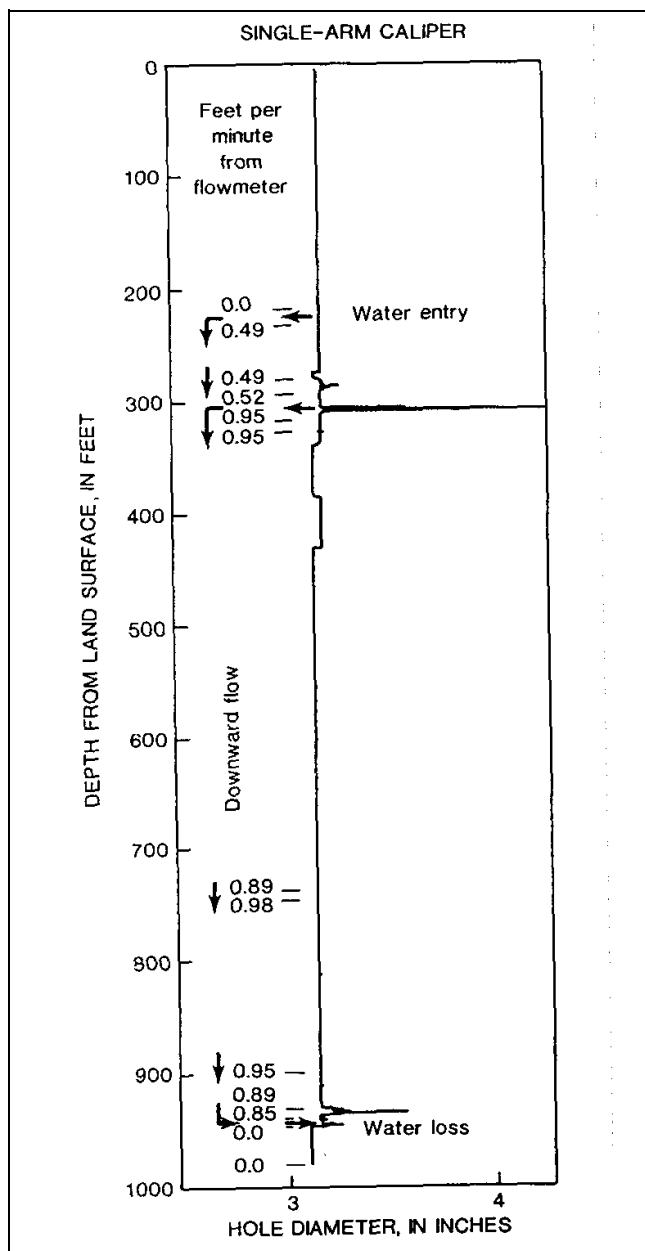

Figure 7-42. Single-arm caliper log on the right and data from heat pulse flowmeter showing zones of water entry and exit

flowmeter were quite reproducible over a period of 2 weeks, even though pumping and injection tests being conducted in a well approximately 300 m from the logged well caused short-term changes. The flowmeter logs and acoustic-televiwer logs at this site enabled the characterization of permeable fractures. In Figure 7-42, the upper fracture zone, at a depth of approximately 300 ft (90 m), and the lower zone, at a depth of approximately 940 ft (290 m), both contain thin, discrete

fractures that are transmitting much of the water, rather than thicker, complex fractures within each zone. Note that slightly less than half of the flow from the upper zone originates in the fracture at a depth of 308 ft (94 m), although that fracture appears to be the widest on the caliper log. Similarly, the fracture that appears to be the largest in the lower zone is accepting only a small percentage of the flow. Acoustic televiwer logs indicated that the same two fracture zones were intersected in other wells in the area and appear to constitute major aquifers. Paillet, Crowder, and Hess (1994) present a detailed description of how the heat pulse flowmeter, in combination with acoustic televiwer logs, can be used to characterize the hydraulic properties of fracture systems that intersect multiple drill holes.

(h) Finite difference modeling software. A critical element in the application of hydrophysical logging compared to established conductive tracer technology is the development of finite difference modeling software routines to simulate the data obtained in the field. This software also permits the calculation of permeability. The method can also be expanded to measure other properties such as water temperature and pH, in order to determine the properties of the formation water entering the borehole. Therefore, fluid replacement logging can indicate the quality and physical properties of water entering the borehole along with the magnitude and direction of flow. In theory, there are no upper or lower limits to the magnitude of flow that can be detected. Published field studies demonstrate that the technique has achieved better low-flow resolution than that reported with other flow measurement techniques (Vernon et al. 1993).

(23) Well-completion logging. Logging to determine the construction of a well is useful for the planning of cementing operations, installation of casing and screens, hydraulic testing, and guiding the interpretation of other logs. Most of the logs described in other sections of this manual can provide information on well construction under some conditions. They will be listed briefly here so the reader can refer to the detailed descriptions of these logs in the appropriate sections of this manual.

(24) Casing logging.

(a) A number of different types of logs can be used to locate cased intervals in wells. Most electric logs will show a sharp deflection at the bottom of a string of steel casing. Resistivity-logging systems that are operating properly will record zero resistivity when all the electrodes are in the casing. Gamma-gamma logs commonly demonstrate a sharp deflection at the bottom of the

casing and may shift at depths where a second string of casing is located outside the first; however, such shifts may be difficult to distinguish from changes in hole diameter. High-resolution caliper logs are excellent for locating the bottom of the inside string of casing and for locating threaded couplings. If small arms are used, they also may provide data on casing corrosion and the location of screens and perforations. Care must be taken to assure that the arms do not get caught in screens or perforations.

(b) The acoustic televiewer is one of the highest resolution devices for obtaining information on casing and screens, but it may be too expensive for some operations. The televiewer must be operated on the mark switch in steel casing, rather than magnetometer, to avoid distortion of the log caused by random triggering. Televiewer logs can provide clear images and accurate locations of screens, perforations, couplings, and damaged casing. Features as small as 1 mm can be resolved under the right conditions. Borehole television can provide some of the same data, but a hard copy of the log is not available for examination at any time. The water in the well also must be clear to allow light transmission.

(c) The casing-collar locator (CCL) is a useful and relatively inexpensive device that can be operated on any logging equipment. The simplest CCL probe contains a permanent magnet wrapped with a coil of wire. Changes in the magnetic properties of material cutting the magnetic lines of flux cause a small DC current to flow, which can be used to drive a recorder channel. The standard mode of operation is to record event marks along the margin of other logs to represent the location of collars in the casing. The event marker is adjusted so that it is triggered when the DC voltage exceeds a certain level. A continuous-collar log can be interpreted in terms of the location of perforations and screens. Corroded casing sometimes can be located by a high-resolution caliper log; spontaneous-potential logs have been used to locate depth intervals where active corrosion is taking place (Kendall 1965). Commercial-logging services are available for detecting corroded casing. An electromagnetic casing-inspection log measures changes in the mass of metal between two coils; loss of mass may be due to corrosion (Edwards and Stroud 1964). A pipe-analysis survey is run with a centralized probe that employs several coils (Bradshaw 1976). This survey is reported to provide information on the thickness of casing penetrated by corrosion, whether the damage is internal or external, and isolated or circumferential. The electromagnetic-thickness survey measures the average casing thickness over an interval of about 0.6 m and can be used to monitor

changes in thickness with time. Casing-inspection logging methods are summarized by Nielsen and Aller (1984).

(25) Logging annular materials.

(a) The location of cement, bentonite, and gravel pack in the annular space outside of casing can be accomplished with several logs, but the interpretation may be ambiguous. A caliper log made before the casing is installed is important to planning cementing or installation of gravel pack. Caliper logs also are useful in interpreting logs run for the purpose of locating annular material, because they indicate the thickness that would be present.

(b) Temperature logs can be used to locate cement grout while it is still warm from setup reactions. Cement-bond logs can be used to locate cement after it has cured, and they may provide information on the quality of the bond between casing and cement and between cement and rock. Uncompensated, short-spaced gamma-gamma logs can indicate the location of cured cement or gravel pack, if a gamma-gamma log was run after installing the casing and prior to filling the annular space; the difference between the two logs may show the filled interval clearly. The pre-cementing gamma-gamma log may resemble the reversed caliper log made prior to installation of the casing. The location of bentonite often is indicated by an increase in radioactivity on gamma logs; however, all bentonite is not more radioactive than the various background materials that might be present.

(c) Acoustic cement bond logging was developed for annular cement evaluation in oil and gas production wells (Bateman 1985). The interpretation of cement bond logs involves the analysis of the amplitude of the compression wave arrival, and the full wave form display. Where pipe, cement, and formation are well bonded, the full wave form display indicates that the acoustic energy from the logging probe is being transmitted to the formation (a formation response is evident). Furthermore, for the case of continuous cement in the annular space with no voids or channels, the compression wave amplitude is a minimum, increasing where the cement is discontinuous.

(d) A quantitative method employing gamma-gamma density logs calibrated for backfill materials is shown in Figure 7-43 (Yearsley, Crowder, and Irons 1991). Below the water surface the saturated sand pack is indicated by a far detector measurement of 1.9 g/cc, and a near detector measurement of 1.7 g/cc, values that were confirmed by physical modeling. The difference in densities between the near and far detectors is due to the greater effect of

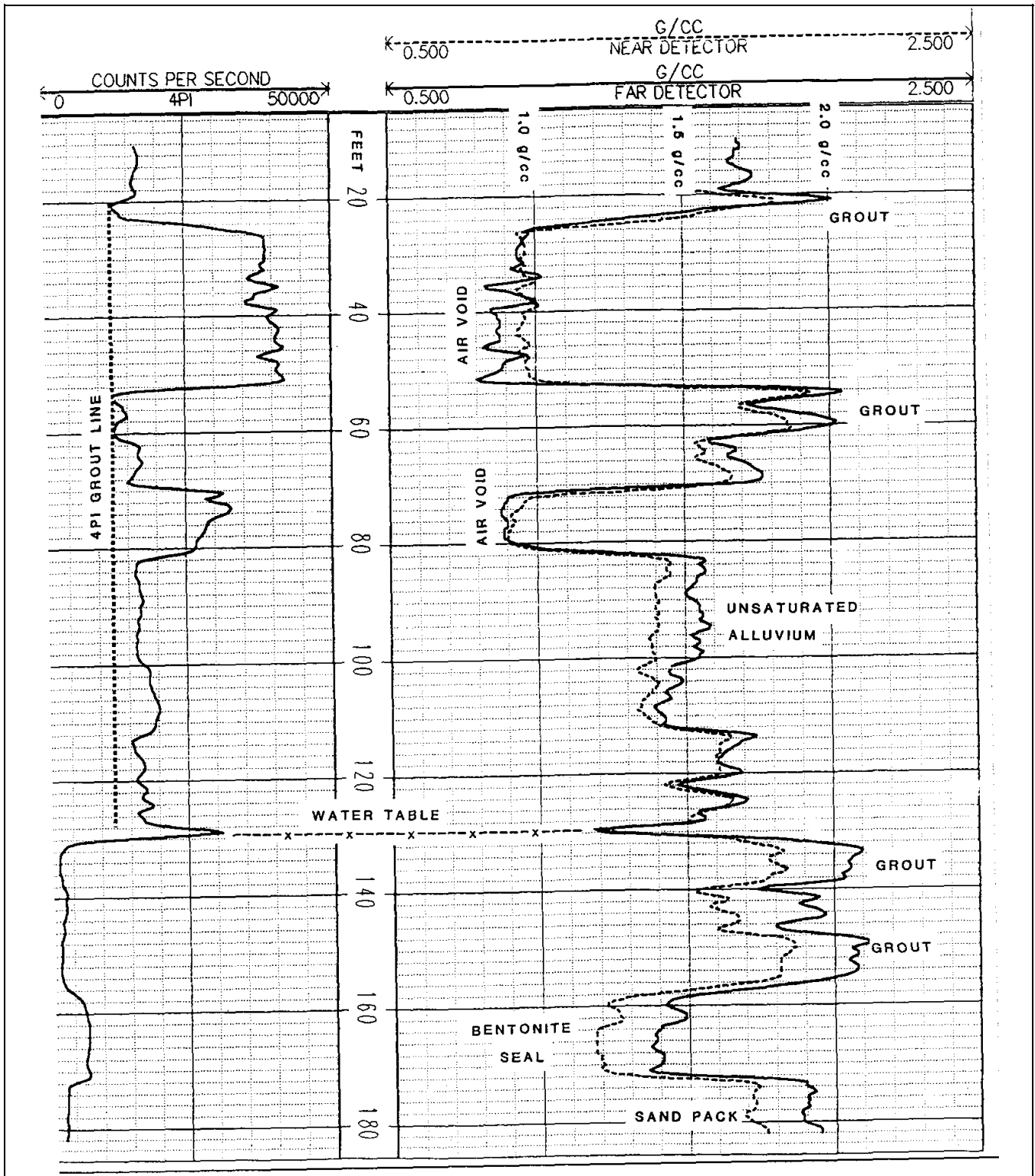

Figure 7-43. Dual-spaced and "4π" density logs in a cased monitoring well showing completion as interpreted from the logs (Yearsley, Crowder, and Irons 1991; copyright permission granted by Colog, Inc.)

the low-density PVC on the near detector. The bentonite slurry seal is less dense than the sand pack, and is readily recognized on the geophysical log, but appears to be 12 ft (3-2/3 m) thick rather than the 5 ft (1-1/2 m) specified on the completion schedule. The water surface is identified by an increase in the  $4\pi$  count rate above a depth of 130 ft (40 m). Also note at the water surface the low densities registered by the near and far detectors and high count rate anomaly on the  $4\pi$  log, which indicate a wash-out at that depth. The cement/bentonite grout below the water surface may be indicated by far detector densities greater than 2.0 g/cc, and near detector densities of approximately 1.8 g/cc. The distinct density contrasts above the water surface in Figure 7-43 result from the density differences among grout, unsaturated alluvium, and air voids. Air voids behind pipe on this log are identified by densities of approximately 1.0 g/cc for both the near and far detectors. Grout above the groundwater surface is interpreted for far detector densities ranging between 1.6 and 2.0 g/cc. The range in density is due primarily to variations in grout thickness. Unsaturated alluvium is indicated by far detector densities between 1.4 and 1.6 g/cc. On the left of Figure 7-43 is a " $4\pi$  grout line," which indicates the expected  $4\pi$  count rate in a 4-in. PVC air-filled pipe with 6:2 cement:bentonite grout behind the pipe.

(26) Borehole-deviation logging.

(a) Deviation of drill holes and wells from the vertical is common; it affects proper completion of the well for its intended use, and it may prevent testing and logging. Casing and pumps may be impossible to install in a well that is highly deviated, and centralized logging probes may not function properly in such a well. The deviation seldom is consistent, so that both the angle from the vertical and direction may change rapidly along the borehole. Even auger holes less than 30 m deep have deviated enough that transmittance logs between the holes are adversely affected. Information on borehole deviation is needed to calculate the true vertical depth to features of interest and to correct the strike and dip of fractures or bedding obtained from such logs as the acoustic televiewer.

(b) Continuous logs of hole deviation usually are run by companies that specialize in this technique. Hole-deviation data usually are not recorded by standard logging equipment, except modern dipmeters, which rarely are included on small loggers. A dipmeter log usually includes a continuous record in the left track of the azimuth (magnetic north) and the amount of deviation. Some hole-deviation services provide a printout of

azimuth and deviation at predetermined depth intervals, and there are several methods to mathematically describe the path of the deviated hole from these measurements (Craig and Randall 1976).

## 7-2. General Crosshole Procedures

*a. Introduction.* The primary purpose of obtaining crosshole data is to obtain the most detailed in situ seismic-wave velocity profile for site-specific investigations and material characterization. Crosshole velocity data are valuable for assessing man-made materials, soil deposits, or rock formations.

(1) The seismic technique determines the compressional (P-) and/or shear (S-) wave velocity of materials at depths of engineering and environmental concern where the data can be used in problems related to soil mechanics, rock mechanics, foundation studies, and earthquake engineering. Crosshole geophysical testing is generally conducted in the near surface (upper hundred meters) for site-specific engineering applications (Sirles and Viksne 1990). All of a material's dynamic elastic moduli can be determined from knowledge of the in situ density, P-, and S-wave velocity. Therefore, since procedures to determine material densities are standardized, acquiring detailed seismic data yields the required information to analytically assess a site. Low-strain material damping and inelastic attenuation values can also be obtained from crosshole surveys. However, the most robust application of crosshole testing is the ability to define in situ shear-wave velocity profiles for engineering investigations associated with earthquake engineering (Mooney 1984).

(2) The objective of acquiring crosshole data can be multipurpose; that is, the seismic velocity results obtained may be used for evaluation of lateral and vertical material continuity, liquefaction analyses, deformation studies, or investigations concerning amplification or attenuation of strong ground motion. Typically, crosshole surveys are a geophysical tool for performing explorations during what are considered phase two field investigations (where phase one field investigations include surface geophysical surveys, follow-up drilling, trenching, and sampling of the in situ materials). During phase two field exploration, the information gathered is more critical to the analytical site-specific characterization. Although both phase one and phase two results are important, the two independent sets of data must be integrated into the final analysis.

(3) Crosshole techniques are most useful when phase one site explorations indicate horizontal and particularly vertical variability of material properties. When layers of

alternating density or stiffness are either known to exist or are encountered during phase one field investigations, then crosshole seismic tests are recommended to define the in situ velocities within each layer. Acquiring crosshole seismic data resolves hidden layer velocity anomalies which cannot be detected with conventional surface methods, allows both final interpretation of other surface geophysical data (seismic or electrical), and permits both empirical and theoretical correlation with other geotechnical material parameters.

(4) In order to have quantitative and quality assured results, crosshole tests performed for either engineering or environmental problems should be conducted in accordance with procedures established by the American Society for Testing and Materials (ASTM). Crosshole seismic test procedures are outlined in ASTM test designation D4428 M-84 (1984). The ASTM procedures provide specific guidelines for borehole preparation, data acquisition, and data reduction/interpretation. Based on ten years of experience, since the inception of the ASTM standard in 1984, crosshole geophysical surveys have become more widely used and accepted for engineering as well as environmental applications. Coupling detailed site information obtained from the crosshole tests with the overall acceptance of the validity of the velocity data, these standards use both empirical correlations for liquefaction and specific input parameters for deformation or ground motion analyses (U.S. Bureau of Reclamation 1989).

*b. Theory and equipment.*

(1) Crosshole testing takes advantage of generating and recording (seismic) body waves, both the P- and S-waves, at selected depth intervals where the source and receiver(s) are maintained at equal elevations for each measurement. Figure 7-44 illustrates a general field setup for the crosshole seismic test method. Using source-receiver systems with preferential orientations in tandem (i.e., axial orientations, which compliment the generated and received wave type/signal) allows maximum efficiency for measurement of in situ P- or S-wave velocity depending on the axial orientation. Due to the different particle motions along the seismic raypath it is crucial to use optimal source-receiver systems in order to best record crosshole P- or S-waves (Hoar 1982). Because only body waves are generated in the source borehole during crosshole tests, surface waves (ground roll) are not generated and do not interfere with the recorded body-wave seismic signals.

(2) Stokoe (1980) demonstrated that particle motions generated with different seismic source types used during crosshole testing are three-directional. Therefore, three-component geophones with orthogonal orientations yield optimal results when acquiring crosshole P- and/or S-wave seismic signals. With three-component geophones there is one vertically oriented geophone and there are two horizontal geophones. For crosshole tests one horizontal geophone remains oriented parallel to the axis between the boreholes (radial orientation) and the other one remains oriented perpendicular to the borehole axis (transverse orientation). In this case, the two horizontal axis geophones must remain oriented, radially and transversely, throughout the survey. This is accomplished with loading poles or with geophones that can be electronically oriented.

(3) P-waves are generated with a sparker or small explosive device (one that will not damage the PVC casing) such that along the assumed straight-ray propagation path the seismic impulse compresses and rarefies the materials radially toward the receiver borehole(s). Experience has proven that for optimal measurement of the P-wave signal, a hydrophone has the greatest pressure-pulse sensitivity for compressional-wave energy. Also, hydrophones do not need to be clamped against the borehole wall; however, water must be present in the receiver borehole in order to couple the hydrophone to the casing/formation.

(4) For either surface or crosshole seismic testing in unconsolidated materials, P-wave velocity measurements are greatly affected by the moisture content or percent saturation (Allen, Richart, and Woods 1980). In crosshole testing the seismic measurements encroach closer to the water surface with each successive depth interval. As the vadose zone and water surface are encountered, P-wave velocities become dependent upon the percent saturation and the Poisson's ratio is no longer a valid representation of the formation characteristics (e.g., Poisson's ratio increases to 0.48-0.49 in 100 percent saturated soils). Hence, below the water surface the P-wave is commonly termed the fluid wave, because its propagation velocity is governed by the pore fluid(s); not the formation density. Fluid-wave velocities in fresh water range from 1,400 to 1,700 m/s, depending upon water temperature and salt content.

(5) S-waves generated in crosshole testing may be split into two wave types, each with different particle motions; SV- and SH-waves, vertical or horizontal

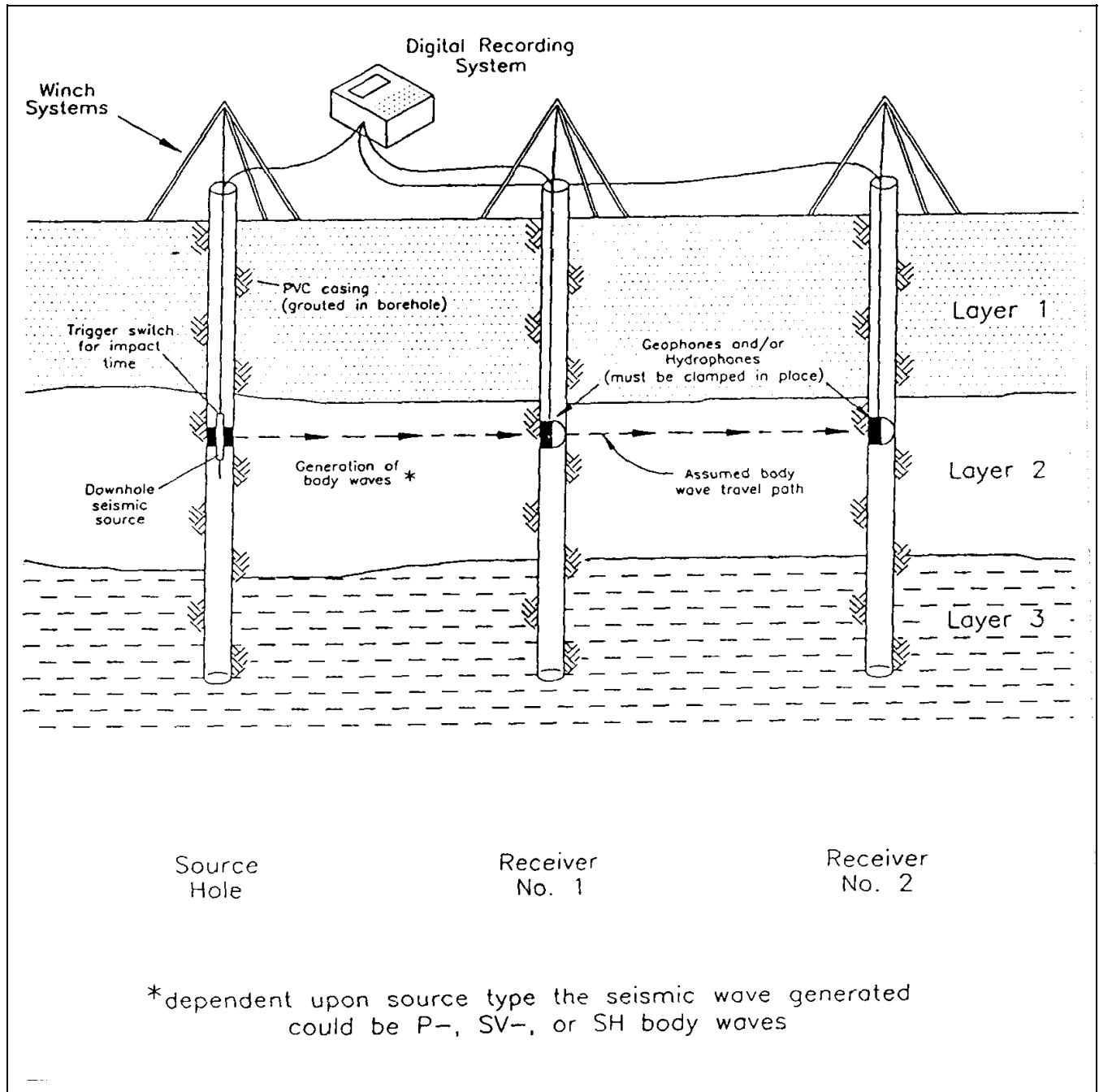
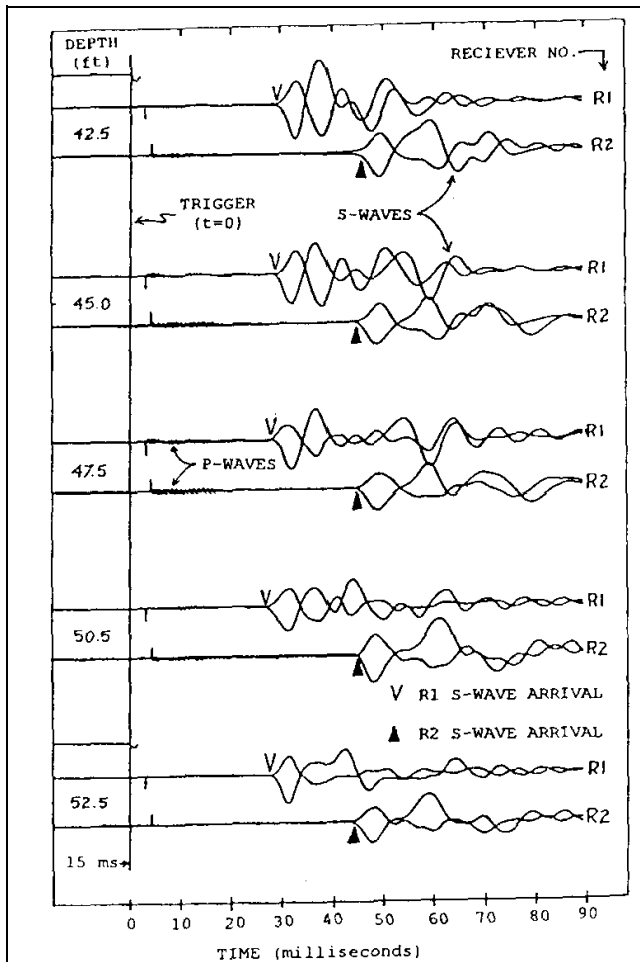

Figure 7-44. Schematic of crosshole seismic method

particle motions, respectively. Shear waves have the unique capability of polarization, which means that impacting the material to be tested in two directions (up or down, left or right) yields S-wave signals which are 180 deg out of phase. A seismic source with reversible impact directions is the key factor for quality crosshole S-wave data acquisition and interpretation. Figure 7-45 shows a series of crosshole SV-waves with reversed

polarity (note the low amplitude of the P-wave energy compared to the S-wave energy) received at both receiver boreholes.

(6) Typically, the S-wave generated in most crosshole testing is the SV-wave, which is a vertically polarized horizontally propagating shear wave. That is, the



**Figure 7-45. Crosshole SV-wave paired-borehole records at five depths**

raypath is horizontal but the (shear) particle motion along the raypath is in the vertical plane. These SV-waves are easiest to generate because of commercially available borehole impact hammers which have reversible impact directions (up or down) and they are also the easiest to record because only one vertically oriented geophone is required in each receiver borehole. Alternatively, SH-waves can be generated and recorded in crosshole testing. SH-waves also propagate horizontally, but their (shear) particle motion is in the horizontal plane (i.e., horizontally polarized horizontally propagating S-waves). Therefore, in order to generate and record SH-wave signals horizontal impacts and geophones are required; also, the orientation of the source and receiver must be parallel while their respective orientation remains perpendicular to the axis of the boreholes (transverse orientation).

(7) Theoretically, there is no difference in the body wave velocity for SV- and SH-waves, which justifies use

of the uncomplicated vertical source for generation of SV-waves, and vertically oriented geophones for signal detection. There are studies, however, which indicate significant velocity dependence of the SV- and SH-waves due to anisotropic states of stress in either the horizontal or vertical stress field (particularly in soil deposits; Redpath et al. (1982)) or fractured rock formations (White 1983).

(8) The requirement for multiple drill holes in cross-hole testing means that care must be taken when completing each borehole with casing and grout. ASTM procedures call for PVC casing and a grout mix that closely matches the formation density. Basically, borehole preparation and completion procedures are the success or failure of crosshole seismic testing. Poor coupling between the casing and the formation yields delayed arrival times and attenuated signal amplitudes, particularly for (higher frequency) P-waves. Matching the formation density with a grout mix is not too difficult, but in open coarse-grained soils, problems arise during grout completion with losses into the formation. Even small grout takes begin to affect the velocity measured between two closely spaced drill holes. Several techniques to plug the porosity of the surrounding formation are commercially available (e.g., cotton-seed hulls, crushed walnut shells, or increased bentonite concentration in the grout mix). It should be recognized that increasing the ratio of bentonite/cement within the grout mix does affect density, but so long as the mix sets and hardens between the casing and in situ formation, quality crosshole seismic signals will be obtained.

(9) Another critical element of crosshole testing, which is often ignored, is the requirement for borehole directional surveys. There are several very good directional survey tools available which yield detailed deviation logs of each borehole used at a crosshole site. Borehole verticality and direction (azimuth) measurements should be performed at every depth interval that seismic data are acquired. With the deviation logs, corrected crosshole distances between each borehole may be computed and used in the velocity analysis. Since seismic wave travel times should be measured to the nearest tenth of a millisecond, relative borehole positions should be known to within a tenth of a foot. Assuming that the boreholes are vertical and plumb leads to computational inaccuracies and ultimately to data which cannot be quality assured.

(10) Recording instruments used in crosshole testing vary considerably, but there are no standard requirements other than exact synchronization of the source pulse and instrument trigger for each recording. Crosshole

measurements rely considerably on the premise that the trigger time is precisely known as well as recorded. The recorded trigger signal from zero-time geophones or accelerometers mounted on the downhole impact hammer allows accurate timing for the first arrival at each drill hole. This becomes uniquely critical when only two drill holes are used (i.e., source and one receiver) because there is no capability of using interval travel times; in this case, the velocity is simply determined through distance traveled divided by direct travel time. Utilizing digital recording equipment affords the operator the ability to store the data on magnetic media for analysis at a later date; but more importantly, digital data can be filtered, smoothed, and time-shifted during analysis. Also, digital signal processing may be directly performed for coherence, frequency-dependent attenuation, and spectral analysis.

(11) Numerous studies have shown that the effects on crosshole measurements by the choice of geophone is not critical to the results (e.g., Hoar (1982)). There are only two requirements for the receivers: the receiver (velocity transducer) must have a flat or uniform output response over the frequency range of crosshole seismic waves (25 to 300 Hz); and, a clamping device must force the receiver against the borehole wall such that it is not free-hanging. The clamping device should not affect the mechanical response of the geophone (i.e., resonance), nor should the uphole signal wire. If an SH-wave source is selected, then horizontal geophones must be used, and oriented as previously described, to detect the SH-wave arrivals. It is paramount that the polarity of each geophone be known prior to data acquisition because the direct arrivals of S-waves with reversed polarity can be easily misinterpreted. Hoar (1982) provides an excellent description of picking P- and S-wave arrivals off recorded crosshole signals. Hoar's dissertation shows that with proper borehole completion, digital recording equipment, and a preferential source-receiver system, clean reversed polarized and interpretable S-wave signals are relatively easy to acquire.

*c. Interpretation.*

(1) For interpretation of direct raypath travel times between two or three boreholes the Bureau of Reclamation (Sirles, Custer, and McKisson 1993) has published a computer program which is designed specifically for reducing crosshole seismic data. Furthermore, the program was fashioned around the ASTM conventions and test procedures outlined for crosshole seismic testing. The program CROSSIT (Version 2.0) is intended to be a step-by-step program that allows the user to:

- (a) Input lithologic information obtained from geologic drill hole logs.
- (b) Input deviation survey data for each drill hole.
- (c) Input travel times for P- and/or S-wave arrivals at one or two receiver holes.
- (d) Enter site-specific information (location, surface elevation, etc.).
- (e) Map each borehole utilizing deviation survey information.
- (f) Determine corrected crosshole distances between the respective drill hole pairs: source/receiver 1, source/receiver 2, and receiver 1/receiver 2.
- (g) Compute direct P- and S-wave velocities from travel time data.
- (h) Tabulate and/or graph (to hard copy or disk file):
  - Borehole directional survey data and plots.
  - P- and S-wave velocity depth profiles from each drill hole pair.
- (i) Interactively edit input or graphical files and combine data sets.
- (j) Post-process seismic data and/or plots for alternate uses.

(2) CROSSIT is built for compatibility with laptop or desktop computers and dot-matrix or laser-jet printers such that data reduction could be performed in the field as geophysical data are being acquired. The logic and flowchart for this interpretation and data presentation program are designed to follow the typical field data acquisition process (i.e., geologic information, borehole information, travel-time information) to permit interactive computer analysis during data collection. This technique of reducing data in the field has proven its value because of the ability to determine optimal testing intervals and adjust the program as necessary to address the site-specific problem.

(3) Unlike surface seismic techniques, crosshole testing requires a more careful interpretation of the wave forms acquired at each depth. For example, in crosshole testing, the first arrival is not always the time of arrival of the direct raypath. As illustrated schematically in Figure 7-46, when the source and receivers are located within



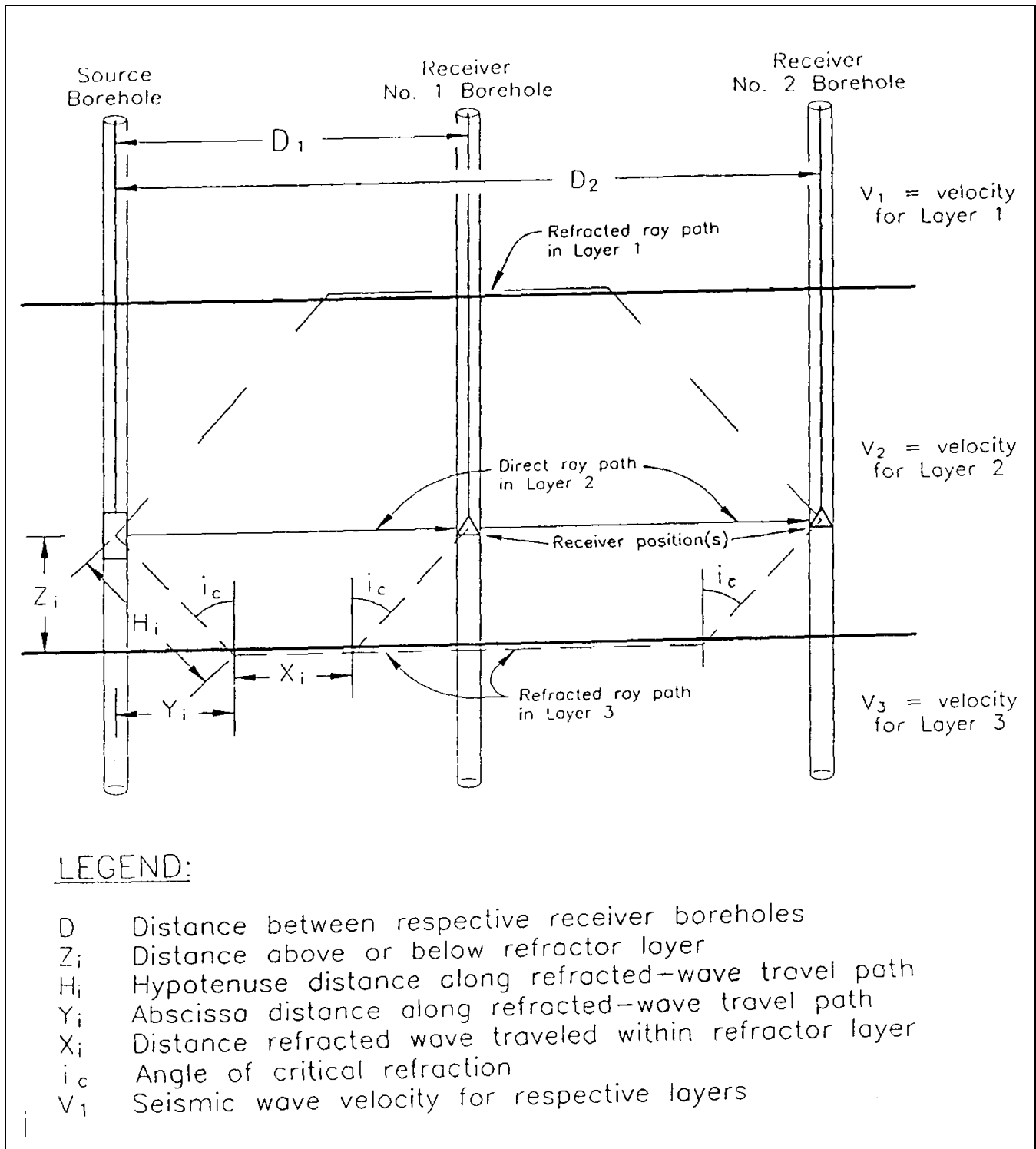

Figure 7-46. Illustration of refracted raypath geometries in crosshole seismic tests where  $V_1 > V_2 < V_3$  and  $V_1 < V_3$

a layer that has a lower velocity than either the layer above or below it (this is termed a hidden layer in refraction testing), refracted waves can be the first arrivals. Both the source/receiver distance above or below the high velocity layer and the velocity contrast ( $V_1 : V_2$ ) across the seismic interface determine if the refracted wave will arrive before the direct wave. Due to the effect refracted waves have on crosshole data sets, ASTM procedures require a three-borehole array because velocity corrections can be made for refracted arrivals. Also, depending upon the velocity contrast across layer boundaries, direct arrivals through low-velocity layers are generally larger amplitude and thereby recognizable. This permits timing direct arrivals directly off the wave form. Figure 7-47 shows an example of (SV-) direct-wave arrivals and refracted-wave arrivals where the arrival time of the direct wave (slower) can be picked later in the wave form behind the low-amplitude refracted-wave arrival. In this example, refractions occur in a situation similar to that depicted in Figure 7-46; that is, refractions occur from high-velocity materials either above or below the low-velocity layer.

(4) When approaching seismic interfaces, refracted-wave arrivals begin to be timed as the first arrival which could (easily) be misinterpreted as direct-wave arrival. Therefore, the following sequence of eight steps (equations) will confirm detection of refracted-wave travel time or direct-wave travel time at each recording depth (ASTM 1984):

Compute  $i_c$ :  $\sin i_c = V_1/V_2$

Compute hypotenuse distance  $H_i$ :  $H_1 = H_2 = H_3 = Z/\cos i_c$

Compute abscissa distance  $Y_i$ :  $Y_1 = Y_2 = Y_3 = Z \tan i_c$

Compute travel times through both materials:

$$t_{V1} = 2H_1 / V_1$$

$$t_{V2} = (D1 - 2Y_1) / V_2$$

[ $V_1$  and  $V_2$  are known from measurement above and below the seismic interface.]

Compute total refracted travel time:  $T_{rfr} = t_{V1} + t_{V2}$

Compute total direct travel time:  $T_{dir} = D_1 / V_1$

Retrieve measured crosshole travel time:  $T_{meas}$

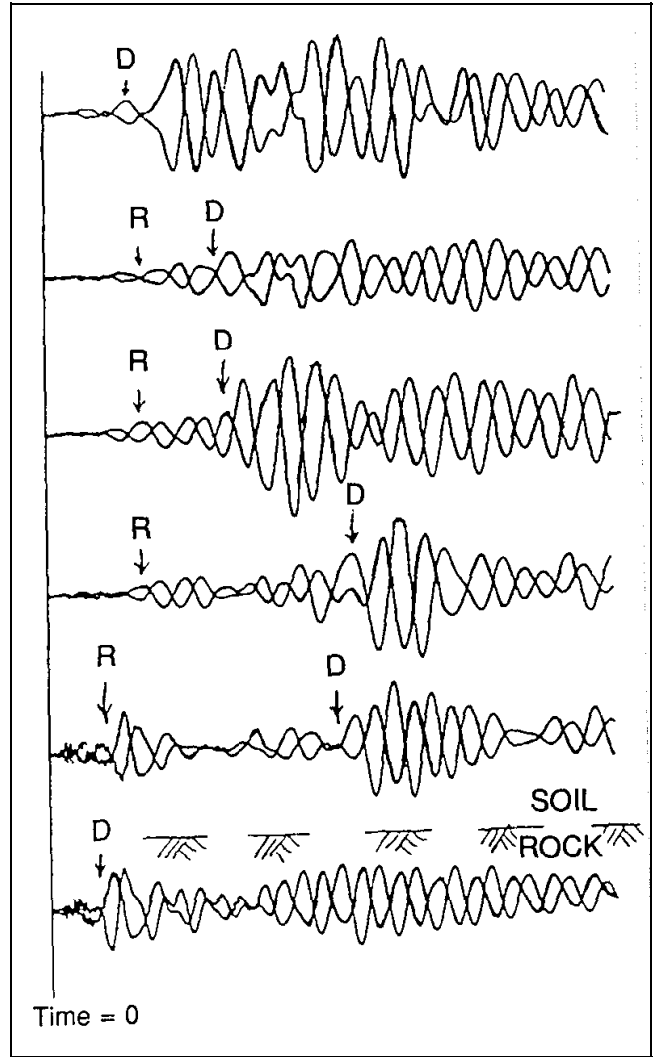

Figure 7-47. Crosshole SV-waves showing direct (D) and refracted (R) arrivals

Compare  $T_{rfr}$  with  $T_{dir}$  and  $T_{meas}$ :

IF:  $T_{rfr} \leq T_{dir} \approx T_{meas}$  THEN: True  $V_1$

IF:  $T_{rfr} \geq T_{meas} < T_{dir}$  THEN: Apparent  $V_1$  (refracted velocity)

(5) Comparing both sets of direct-wave velocities; that is, source to receiver No. 1 ( $V_{(R1)}$ ) and source to receiver No. 2 ( $V_{(R2)}$ ), with the interval velocity ( $V_I$ ) computed from the following:

$$\text{Interval velocity} \equiv V_I = \frac{(D_2 - D_1)}{(T_{meas(R2)} - T_{meas(R1)})}$$

allows easy identification of boundaries with velocity contrasts. When  $V_i$  is much greater than the two computed direct-wave velocities, then refracted-wave arrivals are being timed as first arrivals at the second receiver borehole. Therefore, a systematic comparison of measured travel times, computed direct velocities, and interval velocities at each recording depth enables interpretation of true in situ velocity at all measurement depths. For cross-hole tests, Butler et al. (1978) developed a computer program which performs this comparison of the respective computed velocities determined at every depth. Based on this discussion, to ensure that true in situ velocities are presented, crosshole measurements should be performed a minimum of four measurement intervals *below* the zone of concern to adequately define the velocity profile.

(6) The comparative technique for defining the refractor velocities outlined above assumes that the velocities are constant within each layer; however, occasionally this is an oversimplification. Some deposits have linearly increasing velocity with depth, primarily due to vertical pressures, where the apparent velocity for each depth can be computed with

$$V_{app}(z) = V_i + Kz$$

In these cases  $V_{app}$  is a function of depth ( $z$ ),  $V_i$  is the initial velocity at zero depth, and  $K$  is the increase in velocity per unit depth. Direct-wave velocities computed for the far receiver (R2) at each depth will always be slightly higher than the near receiver (R1); hence, the interval velocity will be even higher. Increasing velocity with depth implies the seismic raypath is nearly circular between source and receiver thereby sensing deeper (higher velocity) material as the source-receiver separation increases. The effect of increasing velocity with depth is greatest within thick homogeneous soil deposits. In these soil conditions, computing an average velocity from the two direct velocities (i.e.,  $V_{ave} = (V_{(R1)} + V_{(R2)})/2$ ) is often the best estimate for presenting the in situ velocity profile.

#### *d. Modelling and data processing.*

(1) Typically, either forward or inverse modeling for cross-borehole seismic investigations consists of computing synthetic travel times to test the raypath coverage and resolution of either unknown or identified velocity anomalies, respectively. For engineering applications there is not much advantage in determining (via modeling) the ray coverage or residual velocity resolution because crosshole testing at the engineering scale utilizes a simple horizontal, straight-raypath geometry to determine average

velocity. Also, lithologic information such as stratigraphy and material type are determined from the drilling and sampling program prior to seismic data acquisition; this allows reliable constraints, or boundary conditions, to be placed on the field data along the boundaries of the material between the boreholes.

(2) For engineering applications, digital signal processing in crosshole seismic tests is, similar to modeling, of minimal value. This, of course, assumes field data are acquired properly and no analog filtering or digital aliasing was performed prior to recording seismic data from each depth. There are a number of digital signal processing techniques useful for determining material properties other than P- or S-wave velocity, as well as confirming the computed crosshole velocity profile, such as:

(a) Spectral analysis for determination of inelastic constants (attenuation and/or material damping).

(b) Frequency analysis for correlation of phase and group velocity.

(c) Cross-correlation of recorded seismic signals from one receiver to another receiver borehole, or source to receiver coupling for signal coherence.

(3) Sophisticated processing is rarely required in (engineering) crosshole testing and the straightforward distance/travel time relationship for velocity computations is considered functional and effective.

#### *e. Advantages/disadvantages.*

(1) Crosshole seismic testing has the unique advantage of sampling a limited volume of material at each test depth. Thus, the final result is a significantly more detailed and accurate in situ seismic (P- and/or S-wave) velocity profile. Crosshole tests are not unique in the use of preferential source/receiver configurations; however, there is the distinctive opportunity to generate and record only body wave energy, as well as preferentially excite particle motion in three directions with respect to the vertical borehole wall. Because of this, the crosshole test permits much easier interpretation of direct arrivals in the recorded wave forms. Because boreholes are required there is the opportunity to obtain more site-specific geotechnical information which, when integrated with the seismic data, yields the best assessment for the engineering application (liquefaction, deformation, or strong motion characterization). Also, because each drill hole was cased for the crosshole tests, additional geophysical surveys should be conducted. Typically, geophysical borehole logging will be conducted in each drill hole for

the purpose of defining lithologic and stratigraphic continuity of the deposits.

(2) Crosshole seismic testing has the definitive advantage of assessing a complex layered velocity structure with alternating high and low relative velocities. Other surface techniques such as spectral analysis of surface waves can theoretically evaluate the high/low layered velocity structure, but due to a number of inherent assumptions associated with surface geophysical methods several non-unique velocity profiles may be derived (from inverse modeling) without specific information about the subsurface layering at the site. Since considerable confidence can be placed on engineering scale crosshole seismic data, computation of in situ low-strain elastic constants (Shear and Young's modulus, Poisson's ratio, etc.) permits dependable assessment of geotechnical parameters for the site-specific evaluation. Recently, sites of particular concern for obtaining P- and S-wave velocities are liquefaction studies where the subsurface contains considerable unconsolidated coarse-grained material and standard geotechnical test procedures (blow counts and material sampling) cannot effectively evaluate in situ properties. For successful engineering analysis of coarse-grained materials, crosshole testing is one of the most acceptable geophysical techniques available.

(3) The primary detriments or obstacles encountered during crosshole testing are typically related to the placement and completion of multiple drill holes. Sites where noninvasive techniques are required due to hazardous subsurface conditions, crosshole seismic tests are not applicable because of tight regulatory procedures regarding drilling, sampling, and decontamination. However, at sites where detailed in situ P- and S-wave velocities are required, drill hole completion must follow ASTM procedures, and when unusual conditions exist (e.g., open-work gravels) specialized techniques for borehole completion should be employed. The U.S. Bureau of Reclamation has encountered numerous sites in the western United States where loose, liquefiable sand and gravel deposits needed to be investigated and crosshole testing effectively evaluated the in situ material density and stiffness with P- and S-wave velocities, respectively; but considerable care and caution were used for completion of each borehole (U.S. Bureau of Reclamation 1992).

(4) Seismic data for crosshole testing need considerably more wave form interpretation because refraction events from high-velocity layers either *above or below* a low-velocity layer must be identified and the first-arrival

velocity corrected. Direct-wave arrivals are easily recognized (even with low-amplitude refracted arrivals) as long as the previously described field equipment is utilized for preferential generation of P-waves or polarized SV or SH-waves. The ASTM requirement of three drill holes seems costly to a project budget; however, the necessary source/receiver configurations and borehole separation allow optimal correction and evaluation of in situ P- and S-wave velocities for each material layer at depth.

*f. Sample problem.*

(1) To illustrate the effect of a high S-wave velocity layer overlying a low S-wave velocity layer on crosshole wave forms, the following sample problem is presented using data acquired at a site in central Utah. Figure 7-48 shows a portion of the wave forms collected over the depth interval 17.5 to 32.0 m, as well as the entire S-wave velocity profile obtained at this site. Only one polarity of the S-waves obtained is plotted over this depth interval (unlike the opposite polarity data shown in Figure 7-47), but the arrival of the S-wave is clearly distinguished from the lower-amplitude and higher-frequency P-wave arrival.

(2) The objective of this investigation was to determine if a low-velocity alluvial layer exists beneath the embankment, which was constructed in 1943. Data are then used to determine the liquefaction potential of the foundation alluvial deposits. As clearly shown on the sample problem figure, directly beneath the embankment the velocities decrease to less than 240 m/s in a layer of lean clay, which is not considered liquefiable; however, within the silty sand alluvial deposits, the wave forms show considerable increase in the S-wave travel times, and the computed velocities indicate potentially liquefiable deposits with S-wave velocities less than 180 m/s (600 ft/s). Beneath approximately 30 m (90 ft) the S-wave velocities gradually increase to greater than 240 m/s.

(3) This sample problem, or example data set, illustrates three distinct advantages that crosshole testing has over conventional surface geophysical testing for these types of investigations:

(a) Ease of identification of direct arrival S-waves.

(b) Ability to determine the presence of low-velocity materials (alluvium) directly beneath high-velocity materials (embankment).

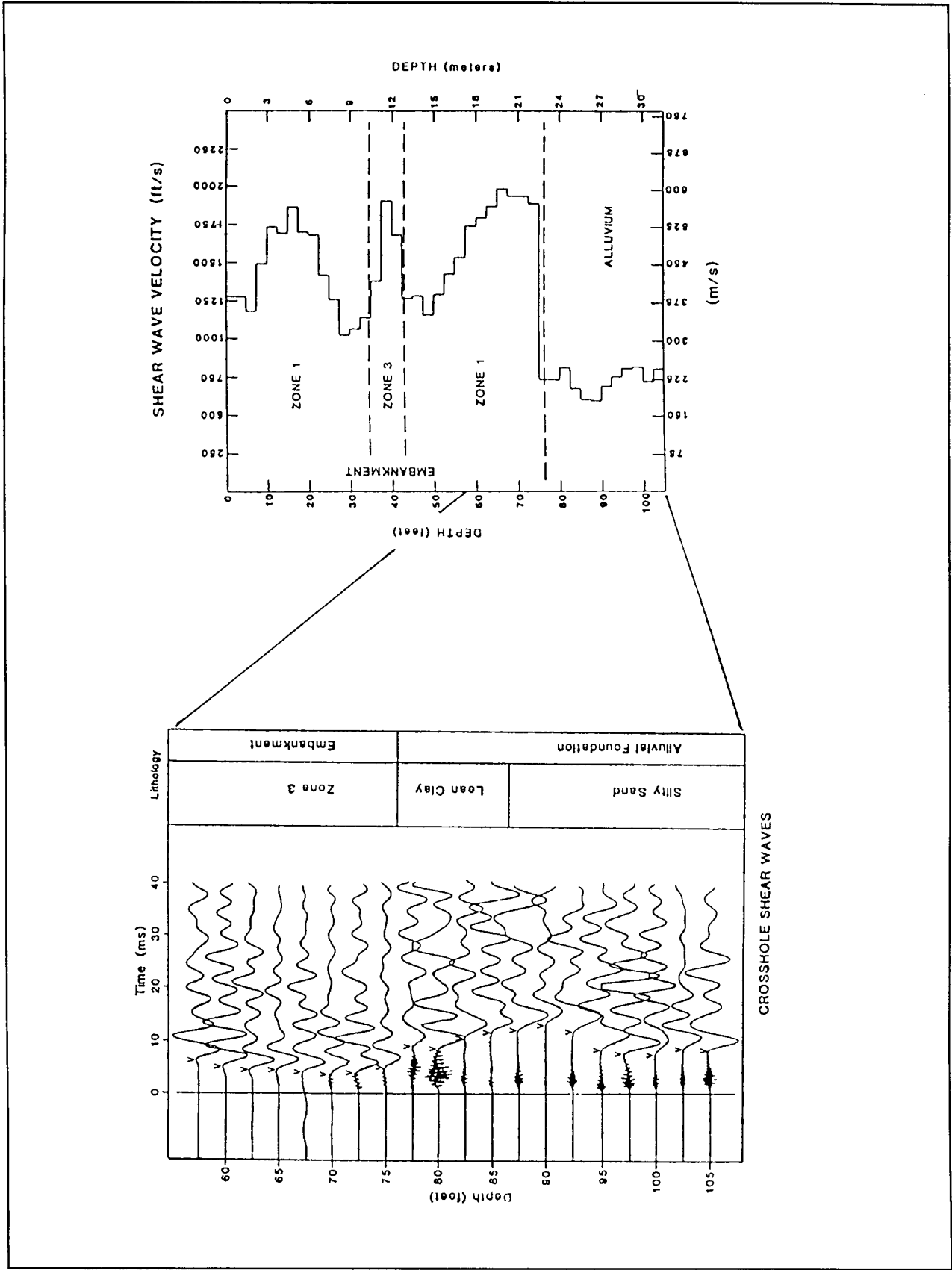

Figure 7-48. Example problem

(c) Direct and fairly straightforward computation of the S-wave velocity profile, which is correlated with the liquefaction potential of both the materials and depth intervals of engineering concern for the safety of the structure.

### 7-3. Surface to Borehole Procedures

*a. Overview of borehole seismic methods.* There are fundamental physical reasons why borehole seismic techniques can provide potentially better answers than conventional surface seismic techniques. There is a progression in both complexity and benefits from check shot and synthetic seismogram to vertical seismic profiles (VSP), three-component VSP, offset VSP, and extrapolation and description of lithologic parameters into the geologic formations surrounding the borehole. Presently VSP's are run in wells to aid in the correlation of surface seismic data. Borehole velocity surveys, commonly called *check shot surveys*, are often expanded into VSP's since additional acquisition costs are relatively small.

(1) Synthetic seismograms. Synthetic seismograms have traditionally been used to correlate surface seismic sections. Like all theoretical models, synthetic seismograms suffer from the simplifying assumptions that go into the model. An approximate fit to surface seismic lines is often obtainable. However, synthetic seismograms offer an important link in trying to understand the seismic tie to the well log. An example of a synthetic seismogram is shown in Figure 7-49.

(2) Velocity surveys. Velocity or check shot surveys are well established in the geophysical community. Sources and receivers are distributed to obtain vertical travel paths through the formation of interest. Receivers are placed at or near geological horizons of interest. On the recorded seismic trace, only the information from the first arrival is used. A velocity survey field setup and recorded field data are illustrated in Figure 7-50.

(3) Time-depth plots. Seismic first arrivals are converted to vertical travel times and plotted on time-depth graphs. The time-depth information is used to calculate average, root-mean-square, and interval velocities.

(4) Sonic log calibration. Sonic log calibration is one of the applications of velocity surveys. Velocity obtained from sonic logs can be affected by a variety of borehole effects. Integrated sonic logs are subsequently distorted by these borehole effects. The resultant discrepancy between seismic and sonic measurements, called drift, must be corrected prior to the construction of

synthetic seismograms to prevent the shifting in time of the seismic reflections or the introduction of pseudoevents.

(5) Vertical seismic profiles. In vertical seismic profiling full use is made of the entire recorded seismic trace, in addition to the first break. Receivers are spaced at close intervals throughout most of the wellbore in order to obtain a seismic section of the wellbore. The seismic wave itself and the effects on it, as it propagates through the earth, are measured as a function of depth. Receivers are now close to reflectors. In addition, both upgoing and downgoing wavefields are recorded at each receiver. The downgoing wavelet with its reverberant wave train is observed as a function of depth and can be used to design deconvolution filters. Signal changes in terms of bandwidth and energy loss can be measured. In general, the VSP also provides better spatial and temporal resolution. Figure 7-50 illustrates the generation and travel paths of direct arrivals, reflected primaries, and examples of upgoing and downgoing multiples.

(a) Vertical seismic profiling permits correlation of the actual seismic event inclusive of all the changes it undergoes, multiples, attenuation, etc., at the actual recorded depth. This leads to a great deal more confidence in correlating surface seismic profiling. An example of correlation between VSP and surface seismic profiling is shown in Figure 7-51.

(b) Resolution in vertical seismic profiling is generally much improved over that obtainable with conventional surface seismic profiling. This is largely the result of the shorter travel path. With VSP's, high-resolution mapping of, for example, a reservoir can be accomplished. Better estimates of rock properties, including below the bit, can be obtained.

(c) The information from the VSP about multiples and signature attenuation can be used to upgrade the processing of surface seismic profiling. In fact, it is anticipated that reprocessing of surface seismic profiling will be done routinely when good VSP data are available.

(d) The inversion of seismic traces from VSP data to predict impedance changes below the drill bit has been demonstrated with remarkable success. This is largely because careful matching of impedances in the known portion of the drillhole has led to increased reliability when predicting below the bit. A popular application is that of predicting overpressure zones. Details of the technique will be discussed under VSP applications.

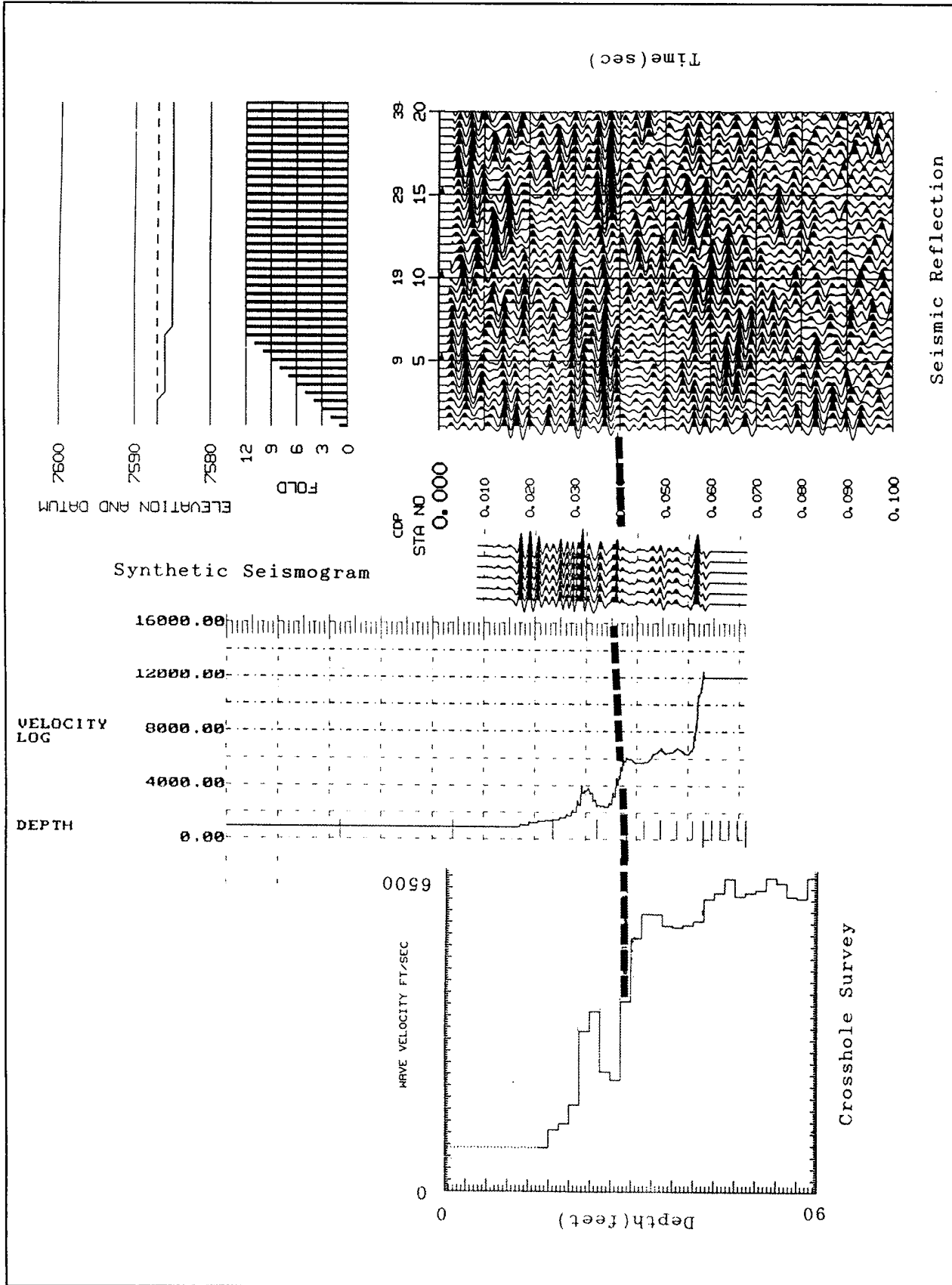

Figure 7-49. Correlation between crosshole survey, velocity log, synthetic seismogram and surface seismic reflection section

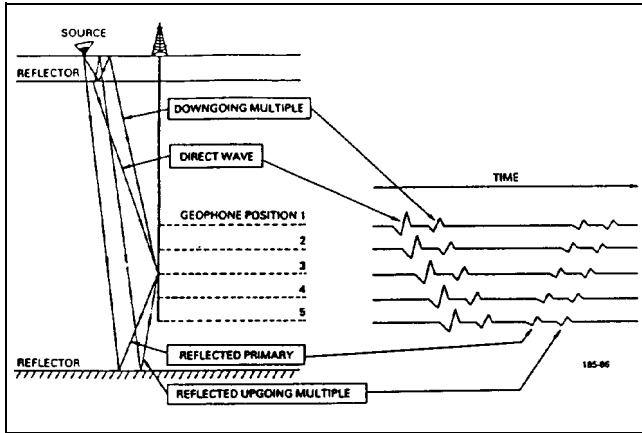

Figure 7-50. Recording of a vertical seismic profile; direct arrivals, reflected primaries, and examples of downgoing and upgoing multiples are shown on the right

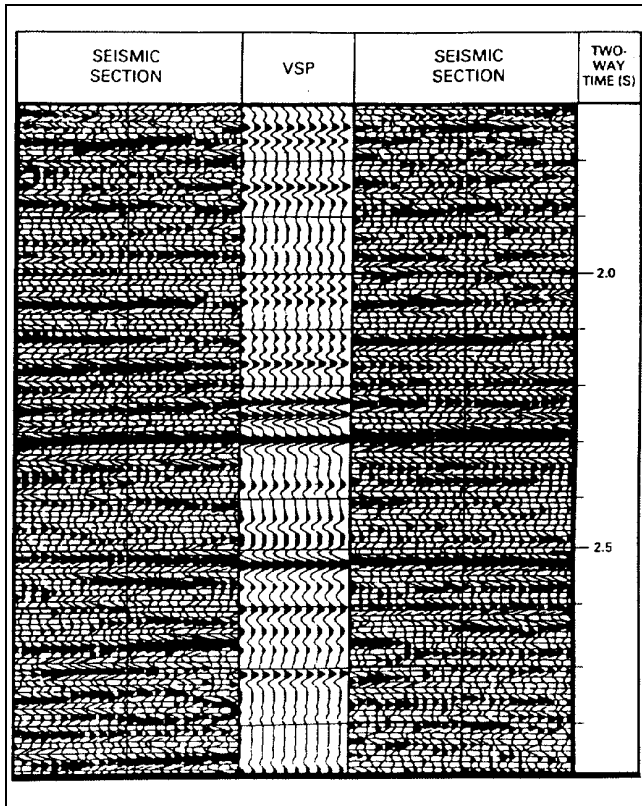

Figure 7-51. Example of correlation between VSP and surface seismic profiling; the VSP data stack is shown at the proper well location with respect to the seismic section

(e) Offset VSP's were developed to illuminate structure away from the wellbore. Applications are primarily

to find faults and pinchouts. An example of an offset VSP is shown in Figure 7-52. The top left shows a fault model. The top right shows a synthetic VSP with the typical break in the upgoing primary reflection due to faulting.

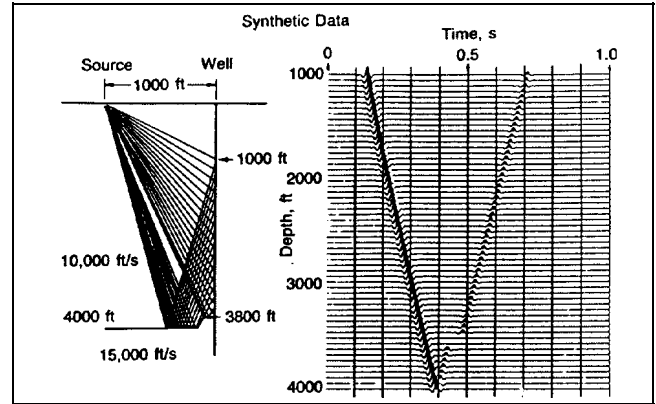

Figure 7-52. Model of fault structure

(f) Multiple offset or walkaway VSP's were developed to supply high-resolution seismic structural detail or provide seismic data in areas where interference from shallow layers all but renders surface seismic profiling useless. Notable improvements have been observed in some no-record seismic areas. Lateral extension of structural and stratigraphic detail around the wellbore is made possible with this type of survey.

(g) VSP's can be obtained around each well in a multiwell project to help map the geology. Careful correlation can be accomplished with existing 2-D and 3-D surface seismic profiling. Finally, the entire sequence of formations of interest may be mapped in terms of porosity, saturation, permeability, etc., by carefully calibrating VSP data with well log data.

(6) Downhole sources. Downhole sources such as explosives, implosive devices, airguns, and sparkers are economically desirable, and a great deal of research has gone into making them successful. Downhole sources suffer from a bad reputation concerning wellbore damage. Data from a number of experiments show that borehole-generated events associated with downhole sources tend to overwhelm data quality to the point of turning this technology into an interpretational problem.

(7) Downhole receiver arrays. Downhole receiver arrays of only a few geophone receiver elements have been used successfully and have greatly reduced acquisition costs in borehole seismics. Downhole hydrophone



arrays have been used commercially to measure permafrost thickness. An interesting application of hydrophone arrays was the successful measurement of tube waves generated by permeable fracture zones in granite.

*b. Velocity surveys.*

(1) Introduction. Velocity surveys in well bores are a well established technology in the geophysical industry. An accurate measurement of the travel time and depth location, in combination with a knowledge of travel path, will provide the geophysicist with the necessary velocities to convert the seismic time sections to depth and also to migrate the data properly.

(a) Sonic logs provide this data also; however, sonic logs are usually run only to surface casing. Tying the information from the sonic log to the surface requires a velocity or check shot survey. Usually, enough levels are obtained in the wellbore to provide sufficient detail to forego the data obtained from the sonic log.

(b) In the section on overview of borehole seismic techniques some problems that can affect sonic log data accuracy were discussed briefly. Seismic travel times are considered accurate within the limitations of sample rate and first break picking accuracy, and sonic times must be adjusted to fit the seismic data.

(2) Field technology. Sources for data acquisition must be carefully chosen for the given desired depth penetration. These sources may include explosives, air-guns, or water guns in containers, or vibrators. Source and acquisition parameters often tend to match those used during acquisition of surface seismic data.

(a) Receivers are downhole geophones. A more detailed discussion of source and receiver characteristics will follow in the section on vertical seismic profiling.

(b) In locating the source, an attempt is made to obtain a travel path that minimizes refractive bending through the formations. For the case of horizontal layering and a vertical well, that would imply placing the source close to the well bore. For a deviated well, the source is frequently moved above the receiver in the well. This, of course, requires information from a well deviation survey prior to the check shot survey. Dipping layers can also introduce sizeable changes in travel time because of refraction along bed boundaries.

(c) When working with surface sources such as vibrators, it is advisable to obtain some shallow levels in

order to get some information on velocities in the weathered zone. The limitation in this case is the source location, since the drilling platform itself may take up a sizeable space. In addition, refracted arrivals from the top of the subweathering zone or casing may interfere with direct arrival through weathering.

(d) When working with explosives, an uphole high-velocity geophone is needed to obtain the uphole times. Proper shot depth with the uphole time can provide the information on weathering velocities. Shot holes are generally located some distance from the wellbore to prevent wellbore damage. Therefore, in this case shallow levels in the borehole may not add much to the survey.

(e) Some comments are in order concerning the placements of geophones in the borehole. Often geologists pick recording depths corresponding to formation tops obtained from logs. If acoustic boundaries of sufficient contrast are in that vicinity, interference between direct and reflected arrivals may lead to errors in first arrival times. Better receiver locations can sometimes be picked below the horizon of interest from existing sonic logs. Another effect may include the gradual polarity reversal of the first break.

(f) If receiver spacing is too close, there may be sizeable errors in computed interval velocities. In this case the picking of the first break is rarely more accurate than 1 ms. With a receiver spacing of, for example, 30 m and a velocity of 3,000 m/s, a 1-ms error would amount to a 10-percent error in the computation of velocities.

(3) Data reduction. When converting travel times to vertical travel times, a straight line path is normally assumed. This is shown in Figure 7-53. Refinement of the results can be obtained by modeling and using the initial straight raypath as a first guess. For a vertical well the horizontal distance from the source to the well and the vertical distance from the source to the geophone in the well are used. For the deviated well, the horizontal distance from the energy source to the geophone is used in addition to the vertical distance. The azimuth of the energy source is required when corrections for deviations are required. For offset or walkaway shooting, where the source is moved, the coordinates must be known for every shot.

(a) All computations are corrected to the seismic reference datum (SRD). These corrections are summarized in Figure 7-54. Finally, the corrected computations are displayed in the familiar time-depth plot shown in Figure 7-55. This graph also provides an opportunity for

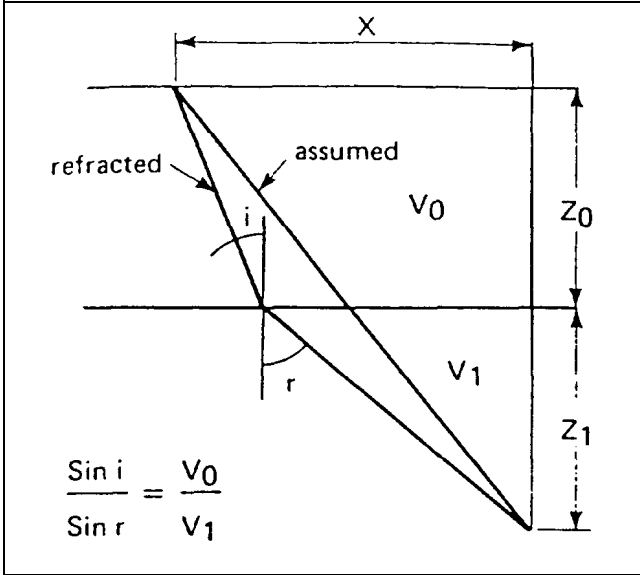

Figure 7-53. Travel path used for converting total travel time to vertical travel time

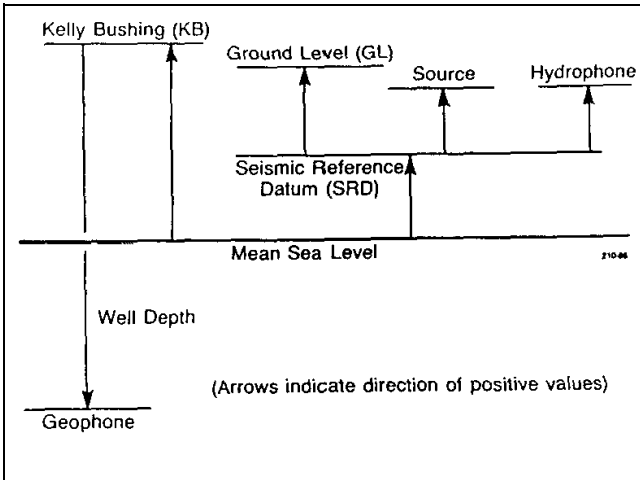

Figure 7-54. Summary of possible corrections to tie velocity survey to surface seismic data

quality control. Points deviating greatly from the trend may require a more detailed evaluation.

(b) Results of the velocity or check shot survey are used to tie time to depth and calculate average, interval, and RMS velocities (see Figure 7-56). These velocities are used to study normal moveout (NMO) in data migration and are often used to correct sonic logs prior to the computation of a synthetic seismogram.

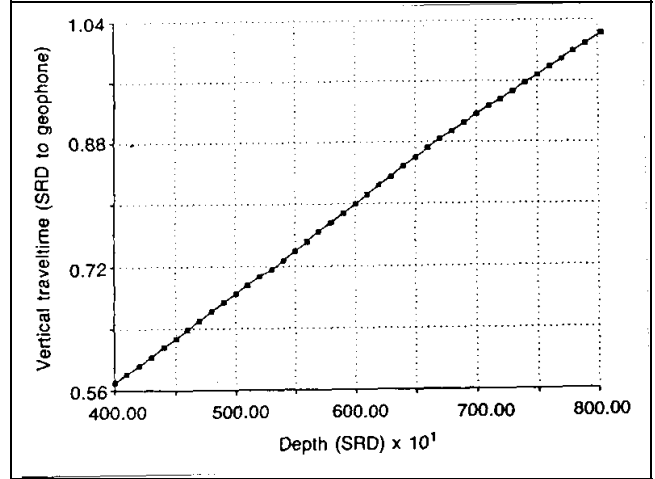

Figure 7-55. Vertical time-depth plot corrected to SRD

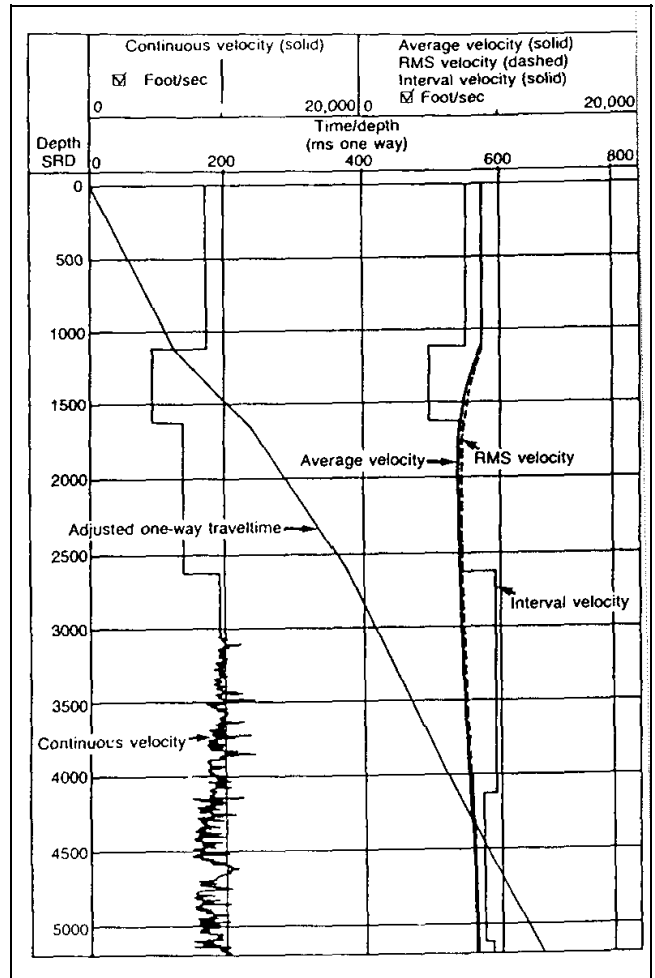

Figure 7-56. Example of final display from velocity survey shown with sonic log

c. Vertical incidence VSP.

(1) Introduction. Vertical seismic profiling has been one of the more rapidly developing technologies in geophysics in recent years. It is perhaps surprising that the information following the first breaks on the seismic trace routinely recorded in velocity surveys was simply disregarded. Acquisition in the field for VSP's consisted then merely of the addition of a sufficient number of geophone depth levels in a routine velocity survey. The additional rig time was perhaps the major deterrent to the widespread use of VSP's in the industry.

(a) The geophysicist had also settled for the use of check shot surveys and synthetic seismograms to provide him with a more or less accurate nexus between surface seismic profiling and the well bore. This meant accepting all the assumptions of plane acoustic waves striking a horizontally layered medium at normal incidence to obtain a model of a seismic trace arriving at the surface. Another shortcoming was the lack of knowledge of the makeup of the seismic wavelet.

(b) The VSP permits the actual measurement of seismic energy as a function of depth. The surface geophone measures only the upgoing wave. The down-hole geophone measures the downgoing wave field in addition to the upgoing wave field. Effects of reflection, transmission, multiples, and attenuation can be traced as a function of depth. The increase in resolution resulting from retention of higher frequencies (due to the decrease in travel path to the downhole geophone compared to a surface geophone) permits more confident measurement of lithological effects than ever before from surface seismic profiling. The advent of shear-wave seismic technology has brought with it the difficulty of resolving both P- and S-waves to the same lithologic boundary. Again, the VSP can provide an accurate tie between these two events. Finally, the VSP is one of the more effective means to provide quality control for both surface seismic profiling and the generation of a reasonable synthetic seismogram. As the geophysicist gains experience with VSP acquisition, processing, and interpretation, this relatively new technology will become an integral part of exploration technology.

(2) Principles. Simultaneous recording of both upgoing and downgoing wave fields by the downhole geophone requires some discussion of the principles involved. In Figure 7-57(b), examples of some possible upgoing and downgoing events are displayed. For convenience and clarity, upgoing events are to the left of the

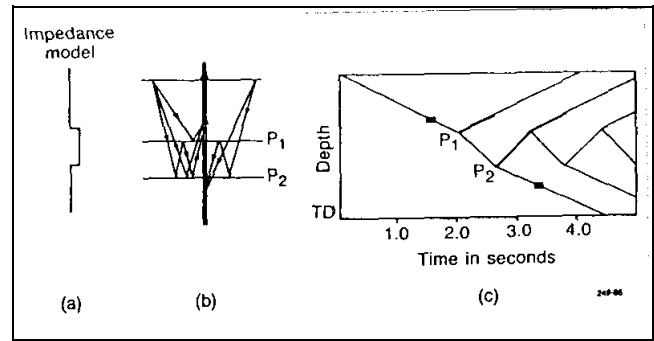

**Figure 7-57. Basic concept of upgoing and downgoing wave fields, (a) Impedance model, (b) Ray geometry, (c) VSP**

well, downgoing are to the right. Furthermore, only two geophone locations are shown, again separated for convenience in illustrating the concept. In reality more events than those shown are possible. Figure 7-57(a) is the simple impedance model for this hypothetical well. Figure 7-57(c) shows the VSP generated from this model as a function of the depth of the well versus one-way time.

(a) The upgoing events shown consist of two simple primary reflections and one multiple. The downgoing events shown consist of the direct arrival and one downgoing multiple. In Figure 7-57(c), the first arrivals are on the left-most line increasing in time with depth; i.e., from upper left to lower right. Changes in slope on this line indicate changes in velocity in the subsurface. Primary upgoing events (P1,P2 in Figure 7-57b) intersect this line of first arrivals and proceed towards the upper right on the graph.

(b) In zero-offset VSP's, the primary events are symmetric to the first arrivals and together with the first arrivals have typically a "V" shape. Primary reflection P1 illustrates the time-depth tie necessary for correlation.

(c) The diagram shows the important fact that upward-travelling multiple events cease as soon as the geophone is located below the last reflector involved in its generation. The primary reflection and all the multiples in its tail have their last bounce on that reflector; hence, when the geophone is below that reflector, primary and upgoing multiple reflections in the tail can no longer be recorded. This multiple, or reverberant, is henceforth only present in the downgoing wave below this point. Upgoing events that terminate within the data permit the recognition of the origin of a multiple.

(d) A real VSP is shown in Figure 7-58. Data have been corrected for amplitude losses. The traces are arranged with depth increasing from top to bottom and time increasing to the right; hence, longer travel times to the first arrival are seen with increasing depth. One should note the sparsity of strong upgoing events and the usual predominance of downgoing multiple events from near surface highly reverberant systems. When lowering the geophone, a downgoing multiple event will be delayed by the same additional amount as the primary event. As a result, in the case of horizontal layering, the whole family of multiples follows but remains parallel to the first arrival alignment. This fact will subsequently be exploited in the processing of the vertical incidence VSP. The first arrivals then draw the time-depth curve. As the geophone moves further from the source, it moves closer to the reflector; hence, the additional delay from source to receiver is equivalent to an identical loss in travel time from reflector to receiver in horizontal layering. As a result, reflected arrivals slope in the opposite direction from first arrivals.

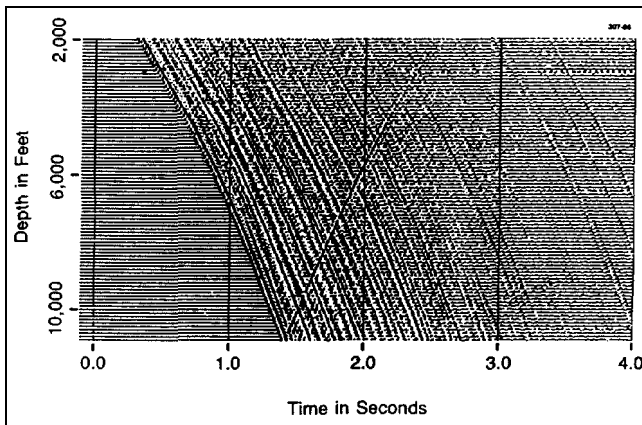

**Figure 7-58. Example of a VSP recording in one-way time with gain correction applied**

(3) Synthetic VSP's. The synthetic VSP is rapidly becoming a valuable aid in studying the behavior of upgoing and downgoing wave fields with acoustic impedances obtained from borehole logging. Whereas the synthetic seismogram models a layered earth as seen from the surface, the synthetic VSP is a study of seismic events as a function of depth. It also allows the interpreter of VSP's to gain a better understanding of the complexities of interacting wave fields and gives more confidence in interpretations.

(a) In calculating synthetic VSP's, one should incorporate the various multiple events. Upward-travelling

multiples are reflected an odd number of times, downward-traveling multiples are reflected an even number of times (see Figure 7-57). For upward traveling multiples, a so-called first order multiple would have been reflected three times, a second order multiple five times, etc. By analogy, a first-order multiple for downgoing waves has been reflected twice, etc. (see Figure 7-57).

(b) For a synthetic VSP, the earth model is divided into equal travel time layers. The total seismic response for the layered system can be computed from the individual contributions of upgoing and downgoing waves at the individual interfaces for all the layers in the model. Multiples up to a given order can be included with overall attenuation as a function of reflection losses. The proper choice of input wavelet again becomes important if one attempts to match a synthetic with a real VSP. It is noted that the real VSP may be contaminated by random and coherent noise, difficult to reproduce with a synthetic. In order to illustrate the principles and the effects illustrated above, a simple model and the synthetic VSP calculated from it are shown in Figure 7-59 (Wyatt 1981). The velocity contrasts in the model are rather large in order to accentuate the effects discussed above. Velocities are seen to range from 1,500 to 6,100 m/s (5,000 ft/s to 20,000 ft/s). Density was held constant.

(c) Real VSP's rarely show multiple events that clearly. The first arrival slopes in this model show the velocity changes clearly. Amplitudes of primary events give a good indication of the impedance contrast at the boundaries. Amplitudes also show how a shallow reverberant system gives rise to many strong multiples. The origin of multiples is also clearly visible on this synthetic VSP. An excellent example of a comparison between a synthetic and a real VSP is shown in Figure 7-60. Coherent noise interference for the example is seen between 5,500 and 6,000 ft on the real VSP. Differences in primary and multiple amplitudes are also very much apparent. Synthetics then become a valuable aid (but not a replacement) for measuring true wave forms in the earth.

(4) Survey sources and equipment. Selecting a source for a VSP survey is largely a function of what was used in obtaining surface seismic data. For improved matching of VSP and surface seismic data, the same sources are desirable for both surveys. To date the majority of seismic data are collected with vibrators, airguns, and explosives. However, a number of other devices have appeared on the market and some familiarity with signal strengths and source characteristics is desirable. A great deal of care must go into the choice of sensors and

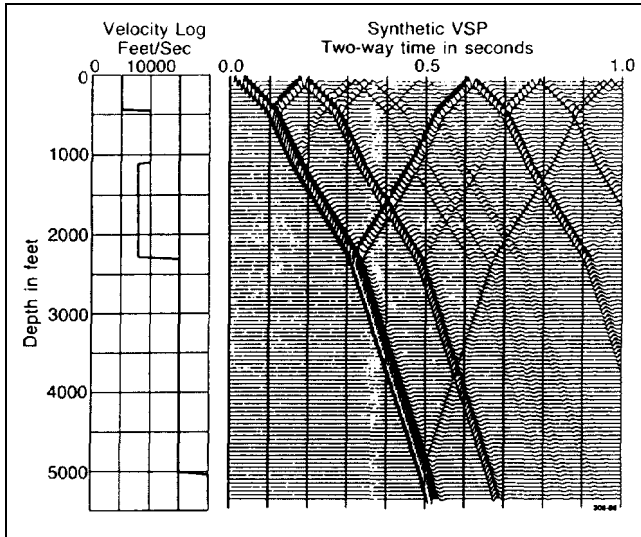

Figure 7-59. Simple synthetic VSP illustrating effects of multiples

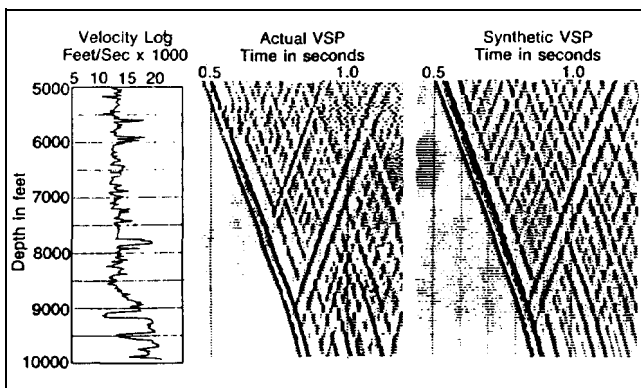

Figure 7-60. Comparison of real and synthetic VSP's

recording equipment. In VSP work, demands on recording equipment and the number of sensors employed are much smaller than in surface seismic operations. Recording equipment may have as few as two channels for single-axis tools. Downhole sensors may have only a single geophone per axis with three-axis tools. Downhole geophone tools require a clamping mechanism. Data for VSP's and check shots have been collected both with geophones and hydrophones in the downhole environment for specific applications.

(5) State-of-the-art technology.

(a) State-of-the-art geophones may be used in downhole seismic data acquisition. A variety of choices are available in the marketplace. As a starting point in downhole tool evaluation the geophysicist should know the

amplitude and phase response of each type of geophone used in the tool. This is of increased importance when considering the differing response characteristics of vertical and horizontal geophones used in the three-axis tools.

(b) Additional complications are introduced by geophone-to-ground or formation coupling. Seismic phase and amplitude are highly distorted upon approaching resonant frequencies. The useable seismic frequency band must then remain well below the frequency peaks introduced by coupling to the formation. These formation coupling effects do exist in the borehole. Here the geophone becomes part of the larger downhole tool, which can, in combination with the formation, give rise to formation coupling resonances. In practice this is mostly experienced with horizontally oriented geophones. With presently available commercial tool designs, coupling resonances have been observed to fall into a frequency range as low as 18 to 30 Hz.

(6) Borehole seismic operations.

(a) For borehole seismic operations, conventional surface seismic systems are more than adequate for most applications. The requirement of only a few channels simplifies the field acquisition. Adjustable fixed downhole gain is most certainly desirable to prevent overdriving of the surface amplifiers by direct arrival.

(b) With continued interest in shear-wave data from three-axis VSP's and large S-wave sources, shear-wave attenuation rates amount to twice the decibel loss of that experienced by compressional waves. Adding attenuation losses from spherical divergence, scattering, and transmission losses would quickly tax the dynamic range of most recording equipment except for rather low frequencies.

(7) Planning. From the preceding sections it has become apparent that more than casual job planning is required to obtain good field data. A variety of additional field parameters are to be determined prior to venturing out into the field. Rig time and source expense often lead to a series of compromises concerning sources, and number of levels obtained in the well. Source offset may be a function of desirable noise suppression of tube waves. Shallow levels are often noisy.

(8) Quality control.

(a) Quality control must extend to the borehole environment. Poor tool coupling may lead to tool creep or slippage. Improved clamping pressure, or perhaps installation of clamping arms or a more suitable length for a

given borehole, will usually solve creep and slippage problems with their attendant noise bursts. Slacking off the cable eliminates cable waves in addition to reducing surface noises traveling down the cable. Tool resonance associated with poor coupling at a given location is solved by moving the tool to a different location. Both caliper and sonic logs may become helpful in relocating the tool.

(b) The effects of casing may lead to additional phenomena in VSP acquisition. Refracted casing arrivals may precede direct arrivals. Unbonded casing may lead to casing ring. Cased hole VSP's can be obtained after the rig has moved off the site. This leads to a sizable savings in rig time during acquisition.

(c) The effect of tube waves in VSP recording is that of coherent noise. Tube waves can be generated by body waves impinging on the borehole or by surface waves crossing the borehole. Tube wave velocities typically come in at velocities of about 1,450 m/s . There are a number of field approaches to reduce tube waves. Improved clamping can greatly reduce tube waves. Another approach to reducing tube waves is source offset from the borehole. This is illustrated in Figure 7-61. Different sources give rise to sizeable differences in tube wave energy.

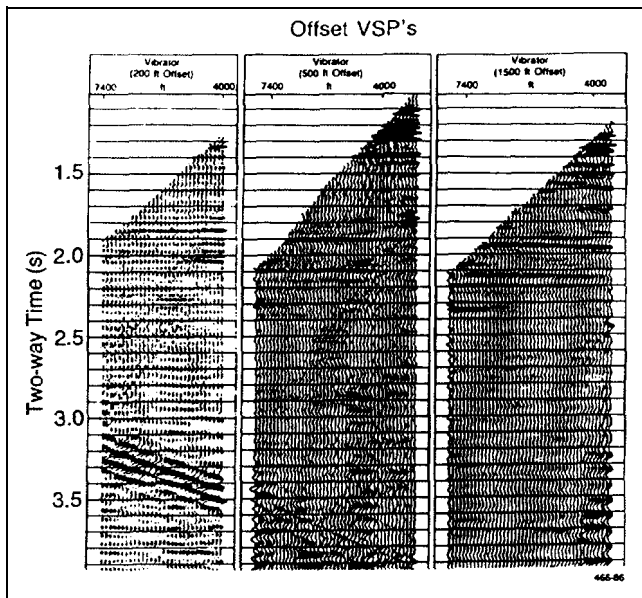

Figure 7-61. Tube wave amplitudes as a function of source offset

(d) With increasing experience in both data acquisition and processing, VSP can supply the additional refinements in seismic exploration that heretofore were elusive

with surface methods. Data from the VSP can now help to solve a number of exploration problems and give the additional confidence often needed to solve interpretational ambiguities.

(e) In the past, direct correlation of synthetic seismograms with surface seismic profiling, however successful in some areas, led to a great number of unresolvable errors between well logs and surface seismic profiling. The synthetic seismogram, after all, is a theoretically calculated response based on some rather simple assumptions and as applied to logging data, is subject to all the various restrictions discussed in earlier sections. With the VSP one finally has a measured response of the earth to the actual source wavefield as it progresses with depth. A connection can now be established directly between seismic analysis and wellbore information. The synthetic then becomes a means to model and study seismic signal interaction with the details of formations rather than serving explicitly as a link to the well. A synthetic log is then relegated to serve to some degree as quality control in the design of VSP data acquisition in conjunction with ray trace modeling and synthetic VSP computations. A well tie that serves both the geologist and the geophysicist will typically include the display of time-scaled logs, synthetic log, corridor or sum stack, the VSP itself, and the surface seismic section. In addition, a VSP converted to an equivalent section by summing corridors of traces along equal offset distances from the wellbore may be included. A variety of displays can now aid the interpreter. Figure 7-62 shows the correlation from time-scaled logs to VSP to surface seismic. Shown from left to right are caliper, gamma ray, bulk density, sonic, reflectivity, synthetic log, corridor stack, VSP-CDP, and surface seismic data.

(9) Conclusions and examples.

(a) From the previous discussions on vertical VSP applications there are many benefits obtainable. Careful calibration of logs with VSP's and calibration of VSP's with surface seismic profiling can lead to much refinement in the interpretive process. Correlation of log-derived lithologic facies can be directly correlated with the results of seismic studies. To establish better communication between geologist, log analyst, and geophysicist, displays such as that shown in Figure 7-63 were developed. Additional calibration with logs and seismic profiling can be achieved by comparing data from seismic events to those obtained from logs. Amplitudes of reflection coefficients and seismic events may be correlated with more confidence to porosity, pore fluids, saturation, and lithology after proper calibration with logs.

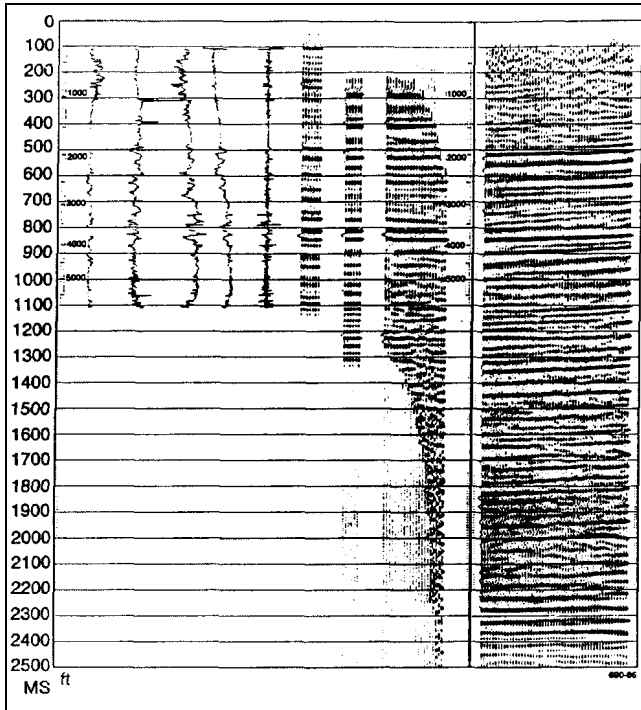

Figure 7-62. Correlation of time-scaled logs with VSP and surface seismic section. Shown from left to right: caliper, gamma ray, bulk density, sonic, reflectivity, synthetic seismogram, sum stack of near traces of VSP-CDP, VSP-CDP, surface seismic section

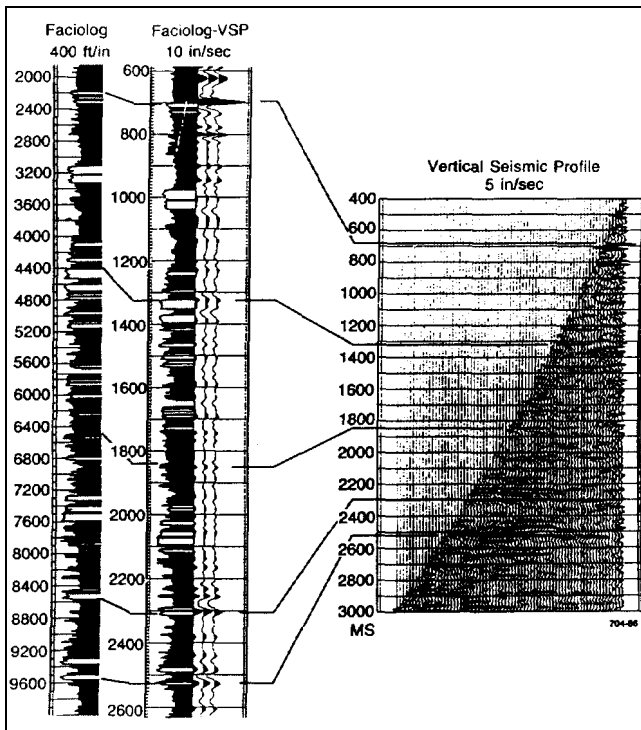

Figure 7-63. Example of tying a VSP to a Facio\*log; i.e., a log-derived lithofacies analysis

(b) An example of how a VSP is correlated with existing log information is also shown in Figure 7-64. In this example from the petroleum industry, the repeated sum stack trace is correlated to a time-scaled, log-derived section of the borehole showing lithology, porosity, and hydrocarbon saturation. The lithologic column indicates the volumetric percentage of the major constituent lithologies of the formation. Note that the peak of the seismic reflector yields an excellent fit with the top of the carbonate section (top of the reservoir). Hydrocarbon saturation, shown on the far left, is seen to increase at the top of the reservoir.

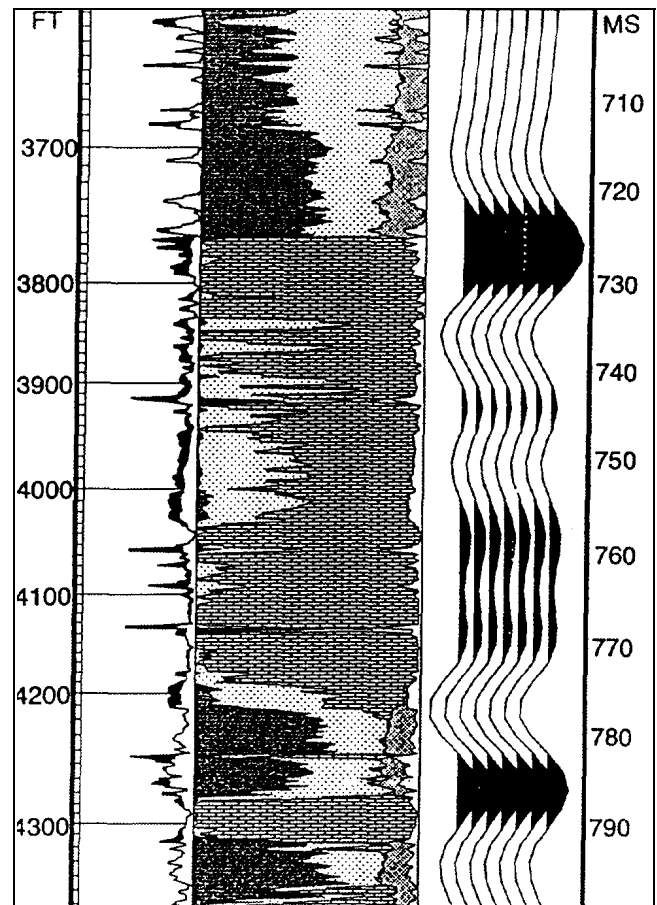

Figure 7-64. Tying the sum stack to log-derived volumetric analysis of lithology, porosity, and hydrocarbon saturation

## Chapter 8 Airborne Geophysical Methods

### 8-1. Scope of Airborne Investigations

Airborne geophysical procedures have had an important impact on the mineral recovery industry. Several advancements in geophysical equipment, types of airborne platforms and global positioning systems (GPS) have provided application to particular engineering and environmental problems. In general, airborne platforms will not often be sufficiently detailed and economic for these latter two topic areas. Airborne methods may be quite reasonable for some specific projects of large area with targets of ample anomaly strength.

*a. Scale.* Scale is an important consideration for airborne procedures to be cost-effective. Sizeable costs are associated with the platform to fly the geophysical equipment. Towing a geophysical “bird,” flight path surveying, and more sophisticated equipment are usually necessary for airborne measurements. For small area sites, where surficial geophysics may be applied, the great cost addition and the reduction of available methods would normally eliminate airborne geophysics. The lessened field strength and the broadening of the anomalous shape as distance increases for potential field methods (gravity and magnetics) normally are counter to the greater detail requirements for engineering and environmental studies. When airborne methods are appropriate, lower and slower flying platforms will be more beneficial for engineering and environmental uses. Helicopters will normally provide more coverage, due to their slower flight speeds and potential for tighter flight paths, than fixed wing transport. Helicopter may also be able to fly at lower altitudes, providing better measurement quality.

*b. Dimensions.* The dimensions of a site may be so great that some airborne geophysical reconnaissance may be prudent prior to other studies. A large site with potential radiometric contamination would be a particular problem type with beneficial airborne geophysical approaches. Moderately sized sites where the surface is hazardous (or extremely expensive) for personnel entry, or is unavailable for personnel access to the site, may be assessed to some extent by airborne geophysical methods.

*c. Purpose.* A study’s purpose will be an aspect to resolve the most appropriate geophysical means. Geologic characterization objectives for a site with significant rock variations may be more likely to employ airborne measures than a site with objectives to delineate large

organic plumes. The anomalous contrast of the objective is the key in resolving whether a geophysical procedure is worthy of a given purpose.

### 8-2. Airborne Geophysical Measures

The three chief airborne procedures are magnetic, electromagnetic, and radioactive methods. Airborne magnetometry (aeromag) is quite common and aeromag maps are available for most of the United States. Aeromag mapping is very useful for mineral exploration and geological studies of magnetic rocks. Airborne electromagnetic methods are used in both the frequency and time domains. Ore body exploration is the chief use of airborne EM methods. Airborne radioactive measurements of gamma rays may be used for uranium and thorium exploration.

#### *a. Magnetics.*

(1) Engineering and environmental surveys could have a varying purpose in which aeromag would provide useful information. Two alternative targets might be considered: site characterization of locale with magnetic rocks or ferrous man-made objects. The differing purposes and targets would necessitate differing flight parameters for the aeromag surveys. Aeromag can be flown for regional geologic structure, which may aid site characterization. Few sites would exist with massive, buried ferrous objects in a region of little magnetic mineralization. Searches for buried ferrous objects would require low-altitude flights in search of local anomalies relative to aeromag for structural investigations.

(2) There are several possible uses of aeromag flights.

(a) One hypothetical situation to illustrate the potential of aeromag use might be the search for buried steel transmission casing over a large site. The horizontal steel pipe would produce a small, broad anomaly near the axis of the pipe. In the case of determining the route of a 1-m-diam, horizontal steel pipe in a sparsely populated region, a magnetometer slung from a helicopter might be able to follow the anomaly route (the pipeline’s unknown path) by survey initiation at a known origin and heading of the pipeline. The search would cross perpendicular to the last observed azimuth following the anomaly using a GPS location.

(b) A short length of vertical, steel well-casing buried below the soil surface would likely produce a sharp, large magnetic anomaly. An aeromag search for unknown, short (< 20 m length) abandoned wells may not



be productive, because the diameter of the anomaly would be so confined that an airborne flight path would be unlikely to pass sufficiently close to the well axis. The separation distance between economically feasible aeromag flight paths would most likely be too large for the well-head search to be successful.

(c) Searches for long lengths (> 50 m) of buried steel casing produce large, broad magnetic anomalies. Properly planned flight paths of aeromag surveys would be likely to encounter the casing's magnetic signature.

(d) The target anomaly, linear but small in the first case, enables the method to be useful for the horizontal transmission lines. The second target of short, abandoned well casing has an anomaly of narrow dimensions and is biased against aeromag discovery. The last case of long, deep casings usually has broad, large anomalies and aeromag surveys should be effective.

*b. Airborne EM.*

(1) The benefit of airborne EM (AEM) procedures is the search for conductors; conductors need not be ferrous objects. Further, air as a medium does not attenuate an EM field. The secondary field from the target, albeit small, is less affected by distance above the surface than aeromag.

(2) There are several different AEM methods in use since the 1960s. Telford, Geldart, and Sheriff (1990) describe the VLF procedure of AEM as follows: "simple, cheap compared to other air surveys, and provides limited data for shallow depths." No one AEM technique would be preferred for different problems.

(3) AEM might provide a better definition of the transmission pipeline example above than aeromag. However, AEM would be much preferred if the pipeline was not a ferrous metal. The target anomaly due to the engineering or environmental problem would suggest whether AEM was an appropriate technique.

*c. Radioactive searches.*

(1) Airborne radioactive searches are obviously limited by the type of source target. These measures would be used infrequently compared to aeromag and AEM work.

(2) Radioactive detectors may be flown for a search of buried radioactive waste containers. As a hypothetical consideration, an airborne exploration for a 1-m-diam,

20-m-long, horizontal lead pipe filled with low-level radioactive waste would be a possible solution.

*d. Complementary airborne surveys.*

(1) Once the platform for one type of survey is selected another method is often added as a comparator for the data taken. Hempen and Hatheway (1992) recommend that complementary methods be utilized to reduce ambiguity and to lessen the number of solution models for the measurements. The increased cost of a second method is small compared to the expense of the airborne platform, its flight path and the labor to conduct the survey.

(2) Aeromag and AEM would be very appropriate complements to locate the steel transmission pipeline in the example above, given that an airborne survey was selected. Airborne radioactive detection and AEM would be supportive of a search for the radioactive waste-filled, lead pipe cited; aeromag would not be acceptable, as a ferrous metal was not involved.

**8-3. Contracting**

*a.* Airborne geophysical surveys are specialized procedures. The nature, scope, and cost of these methods dictates that specialized contractors should provide these services. The cost of airborne geophysical contracts will normally be tens of thousands of dollars. The production by length or area of airborne surveys will compete with surficial geophysics because of the large dimensions covered by airborne platforms.

*b.* Selection of airborne geophysical contractors will be analogous to other geophysical services. The airborne geophysical contractor must have experience, equipment, and documented results from prior airborne services. Preferably the cited work should not only be of the same methodology, but the previous services should resolve a similar problem. Flying AEM for mineral exploration will not be similar in scope to obtaining AEM for engineering purposes. Avoid contracts for services without interpretation. No matter how well another geophysicist can evaluate airborne geophysics, the most prudent contract will pay for useful interpreted results. Flying specialized equipment with complex data streams does not guarantee that the measurements have any application to the purpose for the work. Pay for results, not data.

*c.* Hempen and Hatheway (1992) suggest that client lists be requested of specialty contractors. The cited clients would then be contacted concerning reliability,

timeliness, accuracy, and cost experience with the contractor. Normally, airborne geophysics will be conducted via architect/engineer services with proposal

submissions and evaluation of the proposals. It may be wise to have a government geophysicist on the proposal evaluation team.

## Chapter 9 Remote Sensing

### 9-1. Introduction

*a. Reasons for development.* There are many reasons for the development of a historic land-use profile of sites as a tool for thorough evaluation of the site. Among these are: simple site characterization for project planning, soil conditions, water-land conditions, vegetation analysis, and U.S. Environmental Protection Agency (EPA) requirements such as "Superfund" activities. In addition, good common sense and "best practice" engineering require a thorough knowledge of the site characteristics, including both its historic use and the geotechnical properties of surficial materials. Current site-use parameter studies are comprised of these characteristics, along with indicators and interpretations of historic site development and use. Information recorded in the form of aerial photographs, airborne multispectral scanner imagery, and satellite-borne multispectral scanner imagery provides most of the available, useful, and reliable sources of this historic site development and use data when such data and interpretations are plotted on site base maps.

*b. Requirements.* Requirements for site characterization include such items as (a) site inspections, (b) site investigation, (c) remedial investigations, (d) cultural studies, (e) resource evaluations -- particularly soils, (f) habitat and vegetation studies, and (g) feasibility studies. Clearly, before such actions can be undertaken, the historic use of the site must be known. Valid historic land-use characterization and site descriptions are best developed where aerial photographs or scanner images have been recorded during previous site use. Ground-borne site characterization efforts can then be cost-effectively allocated to those portions of the site containing the greatest interest or concerns, while historically undisturbed portions or portions of little concern may be excluded from such detailed efforts, or verified as areas suitable for limited field exploratory and sampling work.

### 9-2. Capabilities of Remote Sensor Data

*a. General.*

(1) A well-constructed historic site characterization becomes the driving control for the nature, area, and extent of any newly planned land use or development at a site. Sub-areas of the site can be classified as needed. Surficial material properties (geotechnical properties) can

be inferred from signatures interpreted from this remote sensor data.

(2) Aerial photography provides a cost-effective base map of the site. Photogrammetric topographic mapping is so relatively cheap in terms of other expenditures (*e.g.* environmental remediation work, which might cost from several hundred thousand to millions of dollars per site, in 1993 U.S. dollars), that this technique should always be considered. Most modern U.S. Geological Survey (USGS) topographic maps (1:24,000) are of insufficient scale and contour interval (3 and 6 m, 10 and 20 ft) to be of use in detailed site engineering analysis, design, and construction/operation.

(3) An approximate chronology of site activities is the first characterization step. Activity types and previous land use may be identified by photographic or image clues, such as open trenches, burning debris piles, ground and water discoloration, grading scars, vehicle tracks, and structure remains. The sequence of the disturbance and initiation and termination of activities at the site and at specific points on the site may be established within the time frames of the available sequential data sets. Such time frames range from 2 to 3 years up to 5 to 7 years, depending upon local land-use history and past and present development trends.

(4) Specific site activities can now be identified, within time periods, and located on the site base map as a direct guide to field investigation planning for detailed site exploration and sampling. The remains of buildings and other structures may be traced through time modifications and use modifications. Equipment used, material handling methods, and site preparation and abandonment procedures may be identified and evaluated. Changes in these parameters may be noted and many of the daily operational procedures can be interpreted from the evidence recorded on aerial photography.

(5) Offsite impacts of site development and use will be observable on the remote sensor data. However, the exact relationship between site activities and attendant changes adjacent to the site may be difficult to evaluate.

*b. Data requirements for site characterization.*

(1) Historic site use and general, surficial geotechnical characterization require a high degree of detail that is generally well within the normal resolving power of aerial photography collected under normal conditions. These resolution values of about 1 m (or, in the case of large-scale photography flown at low flying

heights, a fraction of a meter) are more than adequate for identification of features and identification of boundaries between material types. The scale of the photographs, images, and of existing maps requires careful consideration. Data collected at a common scale are most desirable. When portions of a data set must be enlarged to match scales of other data with the set, the resolution and detail of the enlarged data set are not equivalent to that of the larger-scale data.

(2) Since 1935, many improvements have been made in aerial photographic collection tools: cameras, lenses, and films. Thus, the data user must recognize the corresponding shortcomings in detail and quality when using historic aerial photography. Photographic data and electromechanical, multispectral scanner data must be mixed with the understanding that film data and scanner data are quite different in recorded spectral information, resolution, and detectability, and different in scale and geometry. Scale selection and data set merging (interpreted thematic maps at photograph and image scales and available or constructed maps) must be carefully considered. Notes and explanations must appear on the thematic maps, identifying ages and scales of the original data, and methods of change in scale, as well as the estimated accuracy of any finished product, with respect to actual field conditions. It is of utmost importance that no overrepresentation of quality be created by scale changes.

*c. Limitation of remote sensor data.*

(1) Remote sensor data record only those conditions at or near the terrain surface which influence electromagnetic spectral response. In particular, most historic data have been collected in the blue-visible wavelength (0.4  $\mu\text{m}$ ) to the reflective infrared (1.1  $\mu\text{m}$ ). Some expanded bands of collection have been made available with the development of electromechanical sensors, the multispectral scanner (MSS), since 1965. However, most of the available, easily accessed, and useful data for historic characterizations are film plate, visible spectrum, and reflective IR data. Although these data record only the details of the terrain surface or surface cover, proper interpretation of tones, patterns, textures, and vegetation provides primary information on geologic and other conditions at some limited depth.

(2) The groundwater regime is one of the most important site characteristics. Remote sensor data have limited application for this type of evaluation of the site, aside from the interpretation of moisture variations based on tone or vegetative response. Some interpretations may be made with respect to the vegetation response or stress

where ground examination of vegetation and soil and water conditions are confirmed to be related to the vegetative stress. Aside from such an indirect means of correlation, groundwater quality and quantity are not particularly extractable from remote sensor data.

(3) Use of remote sensor data for the identification of waste bodies or caches, leachate, or slightly polluted water on the site requires ground-truth verification. Physical facilities, vegetative types, machinery, stock piles, and other items which possess specific shape, pattern, form, erosional features, and so forth, are easily and reliably identified, but more detailed identification of nondescript features without ground examination is risky at best.

(4) Infrequent historic remote sensor coverage over the site, using comparable systems and recording media, may be either limiting or desirable, depending upon the exact study requirements. Historic photography collected for the purpose of topographic map construction will have been collected during leaf-down, nongrowing season conditions, thus yielding minimal information about the vegetative cover and its growth vigor, but allowing for maximum observation of the actual terrain surface conditions. Color-infrared (CIR) photography is generally collected during the peak of the growing season and is most useful for identification of disturbed areas, water/land boundaries, and vegetative characteristics.

(5) The user is clearly limited by having only that site information available on the specific date of the exposure and by the specific weather, vegetative growth, soil moisture, and other conditions at that time. These factors influence terrain contrast, as do atmospheric effects at the flight time and must be considered when evaluating the available photography or imagery. Ground checking of interpreted information from recently or currently acquired remote sensor data is absolutely necessary. Joyce (1978), although a bit dated, provides guidelines for this procedure using Landsat MSS data; these guidelines apply to other types of remote sensor data.

(6) The scales, system, film-resolving properties, and instantaneous field of view of a scanner and its flight line height are factors which control the amount of available detail on a given data set. These factors control the use of data and must be evaluated with respect to all available materials and the scale at which interpreted information is to be displayed as a final thematic map or other product. The problem of implied resolution or detectability that exceeds the capability of the data collection system must always be addressed in any interpretive reports. Lillisand and Kiefer (1994) provide a thorough explanation of how

to calculate resolving and detecting capabilities for remote sensing data.

### 9-3. Characteristics of Various Remote Sensor Data

The remote sensing literature is filled with extensive listings of the characteristics and capabilities of various data sets--both aerial photography and scanner collected. Table 9-1 (Eastman Kodak 1982, 1983) summarizes film sensor capabilities for characterization of historic land-use and geotechnical evaluation.

#### *a. Aerial photography—camera-film systems.*

Camera-film systems have many similar characteristics regardless of film type. Different film types enable the same camera system to capture a different set of spectral data. The three common aerial films are panchromatic (black and white), commonly called "pan," natural color, and CIR.

##### (1) Panchromatic film.

(a) Panchromatic films are most frequently used. These films are sensitive to the visible spectrum; however, in order to eliminate effects of haze and blue scatter from the atmosphere, these films are usually filter exposed only to the visible green and red light wavelengths, that is, minus-blue exposure. This enables the film to record the tonal variations of soil and rock, as well as limited information regarding vegetation. The film is reliable for identification of land forms, erosional and depositional features, water/land boundaries, disturbed land, and all kinds of man-made features.

(b) Historic pan photography frequently has resolution and interpretability similar to that of modern photography, but requires consideration of the effect of exposure conditions in terms of weather, soil moisture, and vegetative conditions at the time of exposure. These conditions have significant impact on terrain contrast, resolution, and the contrast of film prints. Historic climatological data for most U.S. locations are available from the National Oceanographic and Atmospheric Administration (NOAA).

##### (2) Color-infrared film.

(a) Color-infrared (CIR) films have been increasingly used since the 1960s for land-use mapping and evaluation of vegetation types and growth characteristics. CIR films are generally sensitive to visible blue through the reflective infrared wavelengths (about 0.4 to 1.2  $\mu\text{m}$ ). These films are used with an orange filter, thus eliminating

collection of information at wavelengths shorter than the visible green in order to minimize atmospheric effects and to make available a false color reproduction scheme for the reflective IR spectral response.

(b) The major advantage of CIR film processing is that atmospheric effects are reduced by complete elimination of blue light and haze leaving the reflective IR radiation enhanced so as to show the degree of growth vigor or vegetation stress. The reproduction of the terrain observed is normally made in a false color manner: the visible green response is reproduced in blue tones, the visible red response is reproduced in green tones, and the reflective IR response is reproduced in red tones.

(c) Many notable terrain features are easily interpreted from this film or its products. CIR film resolution is adequate to evaluate and identify features critical to site characterization, such as the following: presence and quality of vegetative growth; identification of land/water boundaries and recognition of turbid water, variations in soil, rock, or granular materials; and moisture content variations in exposed soil and rock.

(d) Transport of some waterborne contaminants, as noted by stressed vegetation, is most interpretable from CIR photography. Inventories of vegetative species and habitat are also most easily accomplished using CIR photography. In addition, the advantages of color tones over gray tones (or pan photography) enable the human interpreter to consistently distinguish and identify many more tones.

##### (3) Natural color film.

(a) Natural color films have the sensitivity to collect data in the visible spectrum and to produce a latent recording exactly as the human eye would view the site over the range of the visible spectrum. Only haze filtering is used in the exposure of these films. This filtering is done to provide maximum contrast without the clouding of the film due to the blue light scatter of the atmosphere.

(b) However, the fact that natural color films are exposed to the blue wavelength range of light severely limits the length of the atmospheric path through which the terrain-reflected radiation can travel and adequately create a high-contrast exposure. In comparison with minus-blue exposures, pan film, and CIR film, natural color film is limited from the standpoint of quality of data recorded and flying height for the mission. The principal result is that natural color film must be exposed under

**Table 9-1**  
**General Characteristics of Aerial Film (modified from Eastman Kodak (1982, 1983))**

Kodak Film Type	Film Number	Sensitivity	Description and Applications	Resolving Power,		Diffuse RMS Granularity <sup>a</sup>	Kodak Literature References (Other than M-29) <sup>b</sup>
				lines/mm T.O.C., 1000:1 <sup>a</sup>	T.O.C., 1.6:1 <sup>a</sup>		
Plus-X Aerographic (Estar base)	2402	Panchromatic (with extended red)	Medium-speed, high dimensional stability for aerial mapping and reconnaissance	160	50	20	M-45
Tri-X Aerographic (Estar base)	2403		High-speed, high dimensional stability for aerial mapping and reconnaissance under low levels of illumination	100	40	40	M-24
Double-X Aerographic (Estar base)	2405		Medium-speed to high-speed, standard film for mapping and charting; high dimensional stability	125	50	26	M-75
Panatomic-X Aerographic 11 (Estar base)	2412		Intermediate-speed, very fine-grain, medium-altitude to high-altitude mapping and reconnaissance film; suitable for small negative formats	400	125	9	M-112
Panatomic-X Aerecon 11 (Estar thin base)	3412		Similar to 2412; thin base for increased spool capacity; for medium-altitude to high-altitude reconnaissance	400	125	9	M-112
Plus-X Aerecon (Estar thin base)	3411		Medium-speed, fine-grain, medium-altitude to high-altitude reconnaissance film	160	50	28	M-116
High-definition aerial (Estar thin base)	3414		Thin-base, slow-speed, high-definition film for high-altitude reconnaissance	800	250	8	M-73
Infrared Aerographic (Estar base)	2424	B & W IR	Reduction of haze effects, water location, vegetation surveys, and multispectral aerial photography	125	50	27	M-58
Aerochrome infrared (Estar base)	2443	Color IR	False-color reversal film, high dimensional stability for vegetation surveys, camouflage detection, and earth resources	63	32	17	M-69
High-definition Aerochrome infrared (Estar thin base)	S0-131 <sup>c</sup>		Slow-speed, high-definition, false-color reversal film for high-altitude reconnaissance; high dimensional stability similar to S0-131; ultrathin base for maximum spool capacity; for high-altitude reconnaissance	160	50	9	...
High-definition Aerochrome infrared (Estar ultrathin base)	S0-130		Similar to S0-131; ultrathin base for maximum spool capacity; for high-altitude reconnaissance	160	S0	9	...
Aerocol negative (Estar base)	2445	Color	High-speed, color-negative film for mapping and reconnaissance	80	40	13	M-70
Aerochrome MS (Estar base)	2448		Color-reversal film for low-altitude to medium-altitude aerial mapping and reconnaissance	80	40	12	M-113
Aerial color (Estar thin base)	S0-242		Slow-speed, high-resolution color-reversal film for high-altitude reconnaissance	200	100	9	M-74
Ektachrome EF Aerographic	S0-397		High-speed, color-reversal film for aerial mapping and reconnaissance	80	40	13	M-78

<sup>a</sup> The image structure characteristics of the black and white camera acquisition films are based on processing in a Kodak Versamat film processor, Model 11.

<sup>b</sup> Kodak Publication No. M-29 141 refers to all the films listed.

<sup>c</sup> Films having an SO designation represent averages for relatively few coatings and are the best available data at the time of printing. Future coatings may show variations as products are improved to meet changing customer requirements.

only ideal sky or atmospheric conditions and at low-flying heights (say, less than 1,000 m) or large scales. A large scale increases interpretation problems because of parallax distortion by the camera lens system.

(c) Potential uses of natural color film include identification of water bodies, tone variations in water bodies, dense vegetation versus disturbed areas, evaluation of man-made features, and site layout or siting studies — particularly useful at public hearings.

*b. Electromechanical scanner system imagery.* Electromechanical scanner systems have been used to collect radiation reflected and radiated from terrain. These systems have been borne by both aircraft and satellites. The EPA Environmental Monitoring Systems Laboratory aircraft MSS is a well-known example of one of these systems. Recently the National Aeronautics and Space Administration (NASA) has successfully orbited the thematic mapper (TM) scanner system on Landsat V. The basic specifications of these electromechanical systems are summarized in Table 9-2.

(1) All electromechanical scanner systems have the same basic operational and data display characteristics. Essentially, the scanner system receives radiation from scan lines, oriented perpendicular to the flight path. These data are electronically “chopped” into small units usually of a length approximately equal to the scan line width. Radiation from these small units, called picture elements or pixels, is divided into wavelength bands, and the average intensity of the radiation received for each band is measured by a detector. This magnitude is, via electronics, converted into a digital value and recorded. The pixel size is thus a function of the optical system of the scanner and the flying height. Radiation intensity values are averaged over the entire pixel and then recorded.

(2) *Detectability* applies to the detection and identification of individual targets, in terms of their dimensions and spectral characteristics. This feature of scanner data is significantly impacted by many terrain factors [for example, contrast, reflectivity, moisture content, and pixel composition (what exists within the pixel area on the terrain)], as well as atmospheric transmission of the energy, and the operational condition of the sensor. It is generally accepted that features 2 to 3 pixels in size and homogeneous in composition and spectral characteristics may be reliably and repeatedly identified. Spectral reflections of certain small features or targets with great contrast will also be recorded by a scanner. This brighter target frequently is misrepresented by the mechanism of

data collection. For example, 8-m-wide graveled roadbeds in Iowa’s cornfields frequently reflect such large quantities of radiation that the Landsat MSS data will record 57- by 79-m pixels of road signature. Scanner data are often limited by loss of detail when highly reflective terrain materials obscure less-reflective terrain materials in the pixel area.

(3) The nature of multispectral data makes them attractive for land-use and surface character analysis. By selectively evaluating responses; in particular, spectral bands of scanner data, interaction of responses in various bands, or other processing techniques, the interpreter can select and study the spectral responses in a unique fashion for any site. Such unique spectral responses are not easily studied from film-plate data. Spectral enhancement techniques enable the interpreter to analyze rather unusual spectral characteristics and study features or spectral responses which are otherwise overlooked or never detected on film-plate data.

(4) A major limitation of multispectral image interpretation is the requirement for a computer system to process the scanner data. Software must be tailored to processing exact types of multispectral data. Landsat MSS data manipulation requires digital techniques conceptually similar to aircraft MSS data, but the exact manipulation is quite different.

(5) A major advantage of Landsat MSS and TM data lies in its repeated (as frequently as 8- or 9-day intervals) coverage of any site. MSS data have been available worldwide since 1973. Other sources of satellite-acquired data, such as SPOT, fall into this group. The availability of this coverage provides an opportunity to view the spectral characteristics as they change with seasonal conditions and as the site has historically evolved. This advantage is complicated, though, by 2- to 3-acre detectability and the problem of data absence for possibly critical time periods. Also, MSS data come in large packets; an entire 185- by 185-km (115- by 115-mile) frame is the minimum purchase quantity.

*c. Base maps.* The process of developing a site use or geotechnical characterization starts with selection or construction of a base map, which includes not only the site but also such adjacent terrain as may be influenced by offsite effects and potential site remediation activities.

(1) The most abundant supply of available maps with measured accuracy is the various series of USGS topographic maps. These maps are constructed to meet

**Table 9-2**  
**Spectral Sensing Characteristics of Various Platforms (modified from ASTM (1988))**

Band	Spectral Range		General Applications
	Wavelength (µm)	Color	
Landsat Multispectral Scanner (element size is 57 x 79 m)			
4	0.5 to 0.6	Green	Greatest potential for water penetration; shows some contrast between vegetation and soil
5	0.6 to 0.7	Lower red	Best for showing topographic and overall land-use recognition, especially cultural features, such as roads and cities, bare soil, and disturbed land
6	0.7 to 0.8	Upper red to lower infrared	Tonal contrasts reflect various land-use practices; also gives good land/water contrast
7	0.8 to 1.1	Near infrared	Best for land/water discrimination
Landsat Thematic Mapper Scanner (element size is 30 x 30 m)			
1	0.45 to 0.52	Blue	Designated for water body penetration, making it useful for coastal water mapping. Also useful for differentiation of soil from vegetation, and deciduous from coniferous flora
2	0.52 to 0.60	Green	Designed to measure the visible green reflectance peak of vegetation for vigor assessment
3	0.63 to 0.69	Red	Chlorophyll absorption band important for vegetation discrimination
4	0.76 to 0.90	Reflected infrared (IR)	Useful for determining biomass content and for delineation of water bodies
5	1.55 to 1.75	Reflected IR	Indicative of vegetation moisture content and soil moisture. Also useful for differentiation of snow from clouds
6	10.40 to 12.50	Thermal (emitted) IR	Thermal infrared band of use in vegetation stress analysis, soil moisture discrimination, and thermal mapping
7	2.08 to 2.35	Reflected IR	Band selected for its potential for discriminating rock types and for hydrothermal mapping
EPA Airborne Multispectral Scanner System IFOV of 1.5 mrad (element size is height- and IFOV range- dependent)			
1	0.38 to 0.44	Violet	See information above: TM bands and these bands have the same applications
2	0.44 to 0.47	Blue	
3	0.495 to 0.535	Cyan to green	
4	0.54 to 0.58	Green to yellow	
5	0.58 to 0.62	Yellow to orange	
6	0.62 to 0.66	Orange to red	
7	0.66 to 0.70	Red	
8	0.70 to 0.74	Far to near infrared	
9	0.76 to 0.86	Reflected IR	
10	0.97 to 1.06	Reflected IR	
11	9.50 to 13.50	Thermal (emitted) IR	

National Map Accuracy Standards and are field checked to assure compliance. The use of these maps is severely limited for waste-site-specific studies because of scale and contour interval demands. The largest scale USGS topographic map available in a standard series is the 7-1/2-min series at a scale of 1:24,000 (1 in. to 2,000 ft). Contour

intervals vary with relief on the map sheet but are seldom less than 3 m (10 ft) and may be as large as 13 m (40 ft).

(2) Scales and contour-interval limitations become significant when studying a typically small site of only 4 to 6.5 ha (10 to 40 acres). Methods that might be used to



provide larger scale maps include site surveys, photogrammetric map-making from specific flight-line photography, and enlargement of existing maps. Photogrammetric base maps can be compiled in a matter of weeks, at relatively low cost in comparison with site survey mapping. Photographic interpretation and mapping at existing large-scale photographic scales serve as means of construction of an uncontrolled base map, which must be carefully field checked if it is to be a basis for measurements and calculations or designs.

(3) Enlargement of existing maps which meet National Map Accuracy Standards may be accomplished by many methods: through photographs; through the use of enlarging equipment and drafting, such as Map-o-Graph and zoom transfer scope; or, by grid or slave plotting procedures. The recommended upper scale limit for such enlargements has been determined by the USGS Mid-Continent Mapping Center to be two times, that is, 1:24,000 to 1:12,000; an enlargement of two times is recommended only when it is accomplished in a quality-controlled fashion by means of large-format photographic methods. Without any added information, such as additional contour lines or boundaries, this enlargement will have the integrity of the original map. Enlargements greater than two times require field verification of all information presented. Enlargements of orthophotography and other scale-controlled photography for map production must be made and executed with equal accuracy and precision.

#### **9-4. Sources and Characteristics of Available and Historic Data**

Many federal, state, and local government agencies have sponsored aerial photographic surveys over the past 50 years. Earlier photography was collected primarily for topographic mapping or agricultural land-use acreage estimates. Since about 1960, much more wide-ranging reasons for photographic surveillance of the terrain have motivated the use of different types of film for environmental quality analysis and monitoring. The development of MSS systems and satellite platforms, beginning about 1965, has added greatly to both the amount and quality of remote sensor terrain data. The following paragraphs summarize the most easily accessed, public domain sources of remote sensor data, the types of data available, and their general capabilities for problem solving with respect to site studies.

*a. U.S. aerial photography.* The USGS began its program of mapping photography in the 1930s. The vast amount of this historic photography is pan photography at

good scale and with good exposure reliability. Flight lines were completed with contract specifications of 60 percent forward frame-to-frame overlap and 30 percent flight-line side-lap. These specifications make USGS photography an excellent source of scaled data for use as uncontrolled base map drawings and for identification of the changes in the site layout boundaries and in disturbances through time.

(1) The specified flight and exposure conditions required by USGS for mapping photography make it consistently the best-quality photography available. Cloud cover is not allowable during mapping photography acquisition; flights must be made during clear, minimum-haze conditions. Terrain conditions must be at least leaf-down conditions, without snow or floods. As a result of these requirements, the photography is of high quality, and interpretation of it is straightforward. The only real limitations are that successive missions are years apart, along with those mentioned above in the discussion of pan photography.

(2) USGS mapping photography is well indexed, and a search to determine what is available for a given location is a cost-free service of the USGS and ESIC office. Available photography may be previewed at ESIC offices around the nation, or photo index sheets may be purchased for preview purposes. Contact prints of the 9- by 9-in. photograph negatives are available at the cost of production. Details for searching, examination, and ordering photographs are discussed later in this manual. Appendix II, "Sources of Remotely Sensed Data," in ASTM (1988), identifies sources of photography and imagery.

(3) Since 1980, a group of federal agencies has jointly operated the National High-Altitude Photography (NHAP) Program with the objective of acquiring quality CIR and pan photography over the conterminous 48 states. This photography is of excellent quality, with a CIR scale of 1:57,000 and a pan scale of 1:80,000. This photography was flown during growing conditions, and the CIR capability of recording vegetative growth-signature data makes it a particularly valuable source of recent site history. The first complete coverage, done under leaf-down conditions, was finished in 1986; the second coverage, done under growing-season conditions, was subsequently started; and has been completed.

*b. U.S. Department of Agriculture aerial photography.* Various US Department of Agriculture (USDA) agencies have acquired aerial photography dating from the 1930s. Most of this coverage is on a 7-year cycle,

particularly where agricultural activities are the basis for the local economy.

(1) USDA photography is nearly all panchromatic, acquired for the purpose of crop-acreage measurements. Most of the missions are flown for stereo coverage, but not with the strict specifications used by USGS. However, the resulting bare soil/growing season pan photography at scales of 1:20,000 to 1:40,000 (with some as small as 1:85,000) is quite usable for following time-related site changes.

(2) Availability of the photography does not match that of USGS photography. Search of the Aerial Photography Summary Records System may be made at ESIC offices to determine what coverage is readily available. However, it has been the authors' experience that contact with the county Agricultural Stabilization and Conservation Service (ASCS) or Soil Conservation Service office is much more productive. In fact, these offices frequently have on file a time series of county photography in their offices which may cover the past 20 to 40 years.

*c. National Aeronautics and Space Administration photography and imagery.* NASA has collected CIR and pan photography, and MSS and TM imagery since about 1965. NASA CIR photography is generally exposed at high altitude (1:60,000 to 1:120,000 scale) and during the growing season. An example is Mission 289 (flown in 1974), which covers much of the Mississippi River system and was collected during the early 1970s. This photography is high-resolution stereo coverage and would be quite useful for studies requiring the 1970s site-history coverage. Much of the NASA photography is related to a specific mission objective at the time of its collection. NASA photography is indexed at the EROS Data Center, in Sioux Falls, South Dakota, and will appear on ESIC searches.

(1) Flight plans and conditions of exposure vary considerably. These variations require utility evaluation for each site set of NASA photography. The photography generally has good utility without resolution limitations.

(2) NASA has recently collected high-resolution natural-color, CIR, and pan photography from a satellite-borne camera, a large-format camera aboard the Space Shuttle. The photography, in addition to 70-mm photography collected during the earlier Skylab and Apollo missions, provides some usable data, but all photographs are limited to small-area coverage, existing atmospheric conditions, and flight schedules with respect to terrain and growing conditions.

(3) Satellite-borne multispectral scanners have been the major NASA data collection systems since the successful orbit of Landsat I in 1972. Frames of MSS data are available for the entire 48 states and the rest of the world during all seasons of the year. In many cases, repeated coverage of historic MSS data on an 8- to 19-day basis is available. These data are subject to cloud or terrain condition limitation, but this source remains the single most frequent remotely sensed data available. Some of these frames of MSS data are supplemented by return-beam vidicon data, which is of better detail, much like a high-altitude photograph. Such information is collected over the entire visible spectrum.

(4) Satellite MSS and TM imagery is amenable to map-accurate reproduction. Hard-copy MSS image reproductions at 1:250,000 scale meet National Map Accuracy Standards. Other hard-copy data forms have similar capabilities. These products may be interpreted in a fashion similar to that for CIR and pan photographs. Digital-format data computer-compatible tape (CCT) may be computer processed or enhanced.

(5) Care must be exercised in selection of MSS and TM data. Atmospheric and terrain conditions at the time of imaging must be carefully evaluated in order to determine the value of individual frames. Detectability of specific spectral signatures must be assured by evaluation of terrain conditions since they have an impact on the contrast and spectral response at the time of imaging. Cloud cover, growing season, crop calendar, and moisture content of soils are influential to the image value. If such an evaluation indicates that a particular MSS or TM frame will provide needed data, a search by ESIC will yield a listing of available scenes with the quality of the imaged spectral band, the cloud cover, and the geographic location shown on the printout. The scenes may be previewed at an ESIC office. Alternatively, a single, red-visible band, 1:1,000,000 scale (approximately 9 by 9 in.) is recommended. A hard-copy, photograph type of product should be ordered for preview.

*d. U.S. Environmental Protection Agency (EPA) photography and imagery.* In 1974, the U.S. EPA established a remote sensing branch, which has more recently become known as the Environmental Monitoring Systems Laboratory (EMSL), located at Las Vegas, NV. Through activities of the laboratory and the use of contractors, copious aerial photography and aircraft imagery have been collected over hundreds of known and potential sites of interest to the EPA. EMSL capabilities include pan, natural color, and CIR photography, as well as aircraft-borne multispectral scanner imagery.

(1) EPA/EMSL flight plans and films are mission-specific and quite variable in scales and coverage. Availability of the data for studies is limited to those locations where no current legal action is pending, unless the data user is a member of the enforcement team. In addition, indexing and library storage of these data are not systematized.

(2) Much of the EMSL photography is affected by atmospheric, climatic, or terrain conditions which were present at the scheduled mission time. This often renders the data marginal for use in general site characterization from a historic standpoint. EMSL photography flown at various times is not commonly scale-compatible or equivalent to scales used by other agencies, thus requiring scale modification.

(3) EMSL multispectral scanner data have been collected under much the same conditions as the photography; however, when these data are processed by computer, they are quite usable. Some MSS imagery is flown close enough to the terrain surface to produce small enough pixels for identification of rather small features of interest. Computer processing is required, but this service may be contracted with institutions or agencies which have laboratories with such capability.

*e. Other agencies.* Other federal, state, and local agencies frequently contract for aerial photography for planning or study purposes. The U.S. Army Corps of Engineers, state geological or resource survey agencies, and regional and local planning agencies hold a large amount of uncatalogued photography available only through the office that specified the project. However, such data sets are valuable as a historic record and should be evaluated for use in a site history characterization. From these data sets, local aerial survey firms may be identified and contacted for information regarding photography available from their corporate files. The authors have found that such photography is the best available source of time-sequenced, large-scale, base map capability data. A variety of film types and scales are identified in these sources. Difficulty in securing print or negative copies should be anticipated, as many of the collections are poorly archived. Novel arrangements to gain access for interpretation must be considered where the photography is unique or protected by agency requirements and not releasable on an unrestricted basis.

## 9-5. Data Set Procurement and Merging

*a. Sequence of procurement procedures.* This chapter has identified the most reliable data collections utilized

by the author for site characterization. Appendix II, "Sources of Remotely Sensed Data," in ASTM (1988) summarizes the addresses of these sources and indicates, to some extent, how to access the sources. However, it is important to understand the usual sequence of the procurement and evaluation procedures, and that library locations and methods of access to collections are constantly changing situations.

(1) The initial step in procurement of any data is the identification of available photography or imagery. The ESIC offices access only select repositories; those of the EROS Data Center and Aerial Photo Summary Records System (APSRS). These repositories include a very large percentage of USGS mapping photography, NASA photography and imagery, USDA agency photography, available NHAP photography, and other federal, state, and local planning agencies which have chosen to list their data with APSRS or the EROS Data Center.

(2) A search is initiated by contact with the nearest ESIC office or with the EROS Data Center (User Services Section). The basic information required to implement a search is the site location, type of photography or imagery of interest, data quality, data format, and dates of coverage. The search is a cost-free service and yields printout listings of all available photography or imagery with the quality, geographic coverage, date of collection, cloud cover, and other information for each individual data item.

(3) Evaluation of the search output will require consideration of the weather, soil, vegetation, possible site conditions, and so forth, at the date of each available data set. Reference to National Oceanic and Atmospheric Administration climatological data for the site at the time of data collection will indicate many of the environmental conditions at the collection time. USDA Agricultural Crop Reporting Service information will assist in evaluation of the condition of the land vegetative cover and soil moisture at the time of data collection. Evaluation of these data and inspection of the search printout will usually lead to identification of those data sets that will be potentially most usable.

(4) Selection of the most usable data sets is essential to ensure that the order will indeed provide the required site characterization information. Microfilm is available at ESIC offices for previewing most products listed on a search printout. In cases where a trip to the office is not practical to search for photographic coverage, the investigator should order a photo index, as an inexpensive means of previewing the photography. A pan 1:1,000,000 scale

print of the visible red band of MSS or TM data also serves as an ideal preview sheet. Delivery lead times for USGS, NASA, and NHAP data are 6 to 8 weeks at counter prices. For twice counter price, 1-week delivery is assured. For other sources, such as USDA, longer delivery times should be anticipated.

(5) Discovering historic photography in other source libraries presents a considerably more difficult task. Most local agencies have a means of inventory that will allow quick examination of the available data, but this requires a trip to the agency office. Larger state and federal agencies frequently do not have accessible inventories of photography. It has been found that the best access method is an employee who is familiar with the scope of the collection. Contact with commercial aerial survey contractors is usually profitable and will quickly indicate what has been flown over a site. However, some of this coverage will require permission from contracting agencies to receive prints. In nearly all of the above situations, it has been the experience of the authors that these methods are time-consuming and costly when compared to acquiring USGS or USDA photography, but the same sources should not be overlooked as potentially valuable to the site characterization, starting from the EMSL compilation, and progressing to other sources.

*b. Guidelines for data evaluation, interpretation, and merging.* A number of quality control parameters must be evaluated on each data set in order to assure that the whole database assembled for a site is of equal reliability. These parameters include the reliability of each set of photographs or images, the reliability of the interpretation of each set, the scale quality of each set, and the relationship of the set to selected base maps.

(1) Data interpretation involves photograph interpretation techniques. Clues such as access roads and their landscape scars, disturbed terrain, interpretations of the natural vegetative cover, and spots of bare soil or rock may be the first indications of waste-disposal activities. More subtle indicators will be found during detailed examination of the data. Lillisand and Keifer (1994), Avery and Berlin 1985, Loelkes et al. (1983), and Johannsen and Sanders (1982) contain valuable information and examples of interpretation techniques.

(2) A few more important considerations relate to the total database in order to ensure integrity and maximize the returns in terms of site-use history.

(a) Resolution or detection properties of the data must be clearly identified with each set, in order to ensure

that no misleading detail is implied. Ideally, all sets of like data should be interpreted with the largest ground resolution capability representing the smallest identifiable target.

(b) Degree of organization and accessibility for each data set collection must be indicated.

(c) The original data scale must be identified; a means of scale modification to reach the common study base map scale must be described. Alternatively, interpreted thematic maps may be displayed at the original photograph/image scales, without common-scale conversion. However, this does not provide a basis for comparison of mapped data.

(d) The impact of improved technology of photography and image collection over the period of coverage must be indicated.

(e) Geographic positioning of interpreted features from one time frame to another must be carefully monitored. A good-quality scale-compatible base map will serve to minimize this problem.

(f) Quality control on drafting procedures, the use of stable base materials, and careful workmanship are absolutely necessary.

(3) Equipment requirements are relatively simple and have been discussed in detail in Elifrits et al. (1979), Hudson (1976), and Hudson, Elifrits, and Barr (1976). In summary, the laboratory must be well-lighted, preferably by natural light, must have stereo-viewing equipment, and must have a quality engineering graphics capability.

(4) Digital-format data require a computer system (PC-type or larger) designed to operate image-processing software to enable the investigator to analyze digital data. Output may be in the form of tabular data from the statistical processing routines or in the form of images produced via CRT imaging of the data, or both forms, for visual evaluation and recording by photography or via printer-plotter mechanism.

*c. Geographic information systems - GIS.*

(1) Recent developments in the ability to use geographically registered data sets in what is known as geographic information systems, or GIS, enable the investigator to carefully study combinations of many varieties of data for a given site. Digital format data such as topographic maps and scanner-type remotely sensed data lend

themselves to rapid and easy entry into such computer-contained record systems.

(2) A digitizing capability for entry of maps or other site data that are not initially recorded in digital form is desirable for database-type merging. Digitizing of mapped data may be accomplished by a variety of methods. USGS map products are currently being digitized by the agency for marketing as computer compatible tapes which can be used directly in computer-contained databases. Newly created and revised USGS maps are produced in digital form. Other line maps may be scanned for digitization.

(3) A variety of software and hardware systems for the construction of geographic databases is available. Most systems have the common characteristic of storing information in rows and columns with geographically registered cells assigned values for each theme or file of information. Many advantages of database information management are apparent. Among these are the rapid retrieval of data, the merging and interaction of data files, the mathematical manipulation of files for area or other computational activities, and the capability of addressing the variations in scales of the input data.

## 9-6. Presentation of Data

*a. Presentation format.* Information that has been interpreted from available remote sensor data must be presented in scale-accurate, easily understood form. The most desirable presentation format is that of a base map with various single-thematic overlays which align with base map boundaries, either in hard copy or as files in a computer-contained database. Thematic maps may be constructed at photographic scale, on an acetate overlay, and then scale-adjusted to the base map scale by using a reducer-enlarger. Cultural features (such as levees and roads) may be used for control of the scale adjustment.

*b. Engineering geologic map.* In addition to the presentation of the site historic land-use data and other thematic data taken from remote sensor sources, the final product report should contain an engineering geologic map portraying site exploration efforts, such as water and soil sampling locations, holes, backhoe pits, and geophysical traverses.

## 9-7. Remote Sensing Recommendations

*a. Resource availability.* Readily available, historic remote sensor data are found in a variety of aerial photographs, MSS imagery, and satellite-collected MSS or TM imagery. This is a powerful source for developing site chronologies and inventory of geotechnical parameters. Proper selection and interpretation of remotely sensed data enable the investigator to develop the most accurate evaluation of historic activity and conditions at the site. The impact of site operations on vegetation, soil, surface water, and groundwater may be monitored through time. Bare-soil conditions are especially helpful in evaluating material properties and other geotechnical parameters through photograph interpretation methods. Base maps may be constructed to exhibit these interpreted details.

*b. Quality.* The value of remote sensor data is limited by only a few important factors which must be taken into consideration in any site characterization. Central to this concern is the fact that bits of information can be used to interpret the composition of materials and hydrogeologic parameters. The conditions under which data are collected and the dates of collection control the quality and quantity of information available.

*c. Standardization.* Standardizing the uses of the data will improve outcomes. Examples include the following:

- (1) Vegetation evaluation using CIR photography.
- (2) Appropriate selection of data with respect to collection date and weather and growing conditions, and selection of the terrain conditions which would enable the desired information to be recorded.
- (3) Consideration of the resolution or detection capabilities which would provide the anticipated details.
- (4) Consideration of the scale and comparison of scales which would allow reliable representation of all data, both interpreted and mapped.

An important and common standard for all presentation of data includes proper and sufficient notation on maps indicating the data sources, data interpretation and preparation methods, and their geographic integrity.

## Chapter 10 Engineering Vibration Investigations

### 10-1. Earthquake-Resistant Design

Many Corps' projects could potentially be impacted by earthquakes. HQUSACE is conducting Corps-directed research for particular concerns with dam and reservoir projects. This effort, the Civil Works - Earthquake Engineering Research Program, should provide valuable tools to design resistant structures under earthquake loading. Vast resources of research, publications, and designs for earthquake studies are available in government and public domains.

*a. Guidance.* Several present engineering manuals and engineering regulations provide guidance for considering earthquake impacts on Corps' projects. Several documents are under current revision or review. As the Earthquake Engineering Research Program and other study advances become available, HQUSACE will update its provisions for design and rehabilitation.

*b. Earthquake and project studies.* The provided guidance can only be applied with knowledge of the regional seismicity, regional geologic regime, geologic structure and faulting in the vicinity of the project, the geology of the site, and the site foundation's engineering properties.

(1) Interdisciplinary team. Districts undertaking studies to provide the geophysical, geological, and geotechnical data for a project should consider interdisciplinary teams. A study manager would normally lead the assembled group with some or all the following types of experience:

- (a) Engineering seismology.
- (b) Strong-motion geophysics.
- (c) Structural geology.
- (d) Engineering geology.
- (e) Foundation/geotechnical engineering.
- (f) Hydraulics engineering.
- (g) Structural engineering.

The diverse interests and differing technical language of these team members require close coordination to maintain the project's objective. Team members may not all be within the District's staff or even government service. A cohesive body can establish specific products in harmony with the use of the product in achieving the project goal. The individual study components will more likely suit the following user of the product, if the interdisciplinary team acts as a body requesting information with explicitly stated goals.

(2) Geophysical investigations. Many of this manual's procedures will provide important data to the solution of particular objectives. Some possible resolutions might be as follows:

- (a) Location of faults.
- (b) Crosshole shear velocities of the foundation and embankment on built structures.
- (c) Downhole logging of borings for soil or rock properties or unit contacts.

### 10-2. Vibration Concerns

Blasting programs and vibrating machine foundations compose a set of problems that will not employ procedures from this manual. The sole exception might be S-wave refraction or surface wave studies to determine the damping of founding soil material for a machine foundation.

*a. Blasting programs.* Rock removal and rock quarrying or blast demolition at projects produce three general hazards: ground vibrations, airblast, and projectiles. Thrown ejecta from explosions are solely resolved by the blasting contractor and the risk only occurs near the blasting area. Airblast or noise causes public objections and may break windows. Airblast abatement will be enhanced by proper stemming (granular fill of the blast hole) and avoiding shots during adverse weather or day-time hours. Ground vibrations (and damage to structures) increase with increased explosive weight, reduction of distance to important locations, and adverse geologic factors.

(1) Reduction of blast vibration.

(a) The charge weight per delay is the most important factor within the contractor's control to limit ground motion. Better specifications require that the scaled

distance be limited for the initial shots of the program. Scaled distance is the straight line distance from the shot point of a blast to the closest structure or measurement point divided by the square root of the charge weight per significant delay. Delays are significant when they exceed the longer of 9 ms or 10 percent of the total delay period. Scaled distances above 50 ft/square root of pounds will normally cause no damage to a structure with a substantial safety factor. As the contract progresses, the contractor should be allowed to lower the production scaled distance as long as no damage has occurred.

(b) The distance from the area of shooting and the site geology are not within the contractor's control. The contractor, upon recognizing a difficult condition can carefully select how to progress with the work, at minimum, to approach from a favorable direction. Other controlled blasting measures, such as line drilling and cushion or presplit blasting, may need to be considered with adverse geometry or geology.

(2) Efficient blasting programs. Corps' projects may either direct or be affected by other blasting uses. The use of blast-motion seismographs is recommended when there are concerns on government property from the blasting of others. Directed blasting contracts by the Corps may have unforeseen outcomes, if the programs are not carefully considered. The art of blasting has developed significantly in recent decades. Buildings, chimneys, and bridges have been safely removed without damaging adjacent structures.

(a) Government-directed blasting contracts will normally be more expensive and not as likely to achieve quality results. Performance contracts for blasting with specific contract safety limitations secure better production at lower costs. The contractor would have a specified goal in a performance contract. The contractor may use any cost-effective method to secure the goal within the limitation of the contract. Contract limitations would be as follows:

- Worker safety.
- Avoiding structural damage.
- Maximum ground vibrations at provided locations.
- Limiting airblast and flyrock.

(b) Performance contracts have another important benefit besides quality results. Performance contracts reduce the government's liability while blasting is being

accomplished. The contractor is choosing the method to perform the goal without government approval. The specification should provide that required information be submitted to the government before each shot without the approval of the shooting program.

*b. Machine vibrations.* Design of large vibrating machines is normally undertaken by structural engineers. Vibrating machinery that develops harmful oscillations will normally have expensive remediation. Structural engineers may request geotechnical foundation designs to rehabilitate or install large machinery. Base isolation, adjusting the block foundation's frequency, or assessing the foundation's damping may need surface wave techniques to provide effective solutions.

### **10-3. Acoustic Emissions**

*a. Monitoring.* The monitoring of acoustic emissions or microseismic activity has been used to isolate distressed portions of engineering structures as load is increased. In earth materials, it has been used to predict failure of landslides and other unstable natural structures. Progressive or alternate loading can result in local structural failures at points where the stress concentration exceeds the strength of the material. Due to the inherent inhomogeneity of most materials, each failure in turn alters the natural strength of the adjacent material. As the stresses (and resultant strains) are redistributed in the structure, stress (seismic) waves are emitted contributing to the phenomenon of spontaneous stress-wave emissions, known as *acoustic emissions*.

(1) Individual acoustic emissions are frequent, spontaneous, and normal in most structures coming under load. The monitoring of the signals is thus complicated by the requirement of recognizing what is a "normal" response to loading, and what is a signal of incipient failure. As individual events are not ordinarily important in and of themselves, the instrumentation is usually set up to count only events stronger than a certain background and to normalize the count of these events over time. Thus, number of events per minute is the typical monitoring parameter. The amount and type of monitoring is adjusted to the expected load profile and to the expected failure time horizon. Thus, sheet piles under river loads may be monitored only for an hour once a day to get a representative number and then monitored continuously under flood conditions to measure pile performance and/or long-term variation in response to similar loads. Landslides may be similarly monitored on a weekly basis during the dry season, and at some daily rate when water is present and failure more likely.

(2) Equipment must also be fitted to the scale of the problem. As recording fidelity is not important, often the transducer is mounted so as to achieve some mechanical amplification of the signal. Steel rods driven to bedrock with accelerometers mounted within a meter above the surface have been used in landslide investigations, while pipes welded to piles have been used to mount velocity transducers in other studies. Specialized instrumentation is available which will report the number of events per minute, the average number of counts per minute, and the number of counts per event. Obviously there is substantial latitude in defining what is an event and what is a count. Additionally, mechanical amplification will accentuate the effect of any external noise impacting the structure.

*b. Acoustic emission recordings.*

(1) Failure-prone underground mines have used similar monitoring systems with one important difference. By using an array of detectors and a real-time processor, locations of events within an active mine have been obtained on a daily basis. When presented as a map, this information can be of economic benefit to mine operators.

(2) One problem with acoustic emission analysis is the determination of success. The intent of the analysis should be to define in advance an adverse occurrence by its distinctive emission rate. If the pattern of acoustic emissions leading to failure is recognized only after the failure, the program has not been a success. Any program should undergo a thorough evaluation before it starts and satisfactory answers to the following questions should be accepted by all participants, including the consumer of the information.

(a) What phenomena are being directly monitored?

(b) What properties are being inferred from the measurement (attempted to be resolved)?

(c) What horizon of prediction is being investigated, and are the events sufficiently detailed or numerous that success or failure can be measured?

(d) What constitutes success or failure?

(e) Considerable empirical adaptation of these methods to each site-specific area is required.

#### 10-4. Nondestructive Testing

*a. System types.* Nondestructive testing is available through a variety of sources. Systems may be based upon electromagnetic, seismic, thermal, and x-ray evaluations. Tests do not “harm” the evaluated feature and are considered diagnostic of each element tested. Better systems offer real-time evaluation of the feature.

*b. Seismic deployment.* Most seismic versions of nondestructive testing methods as applied on construction sites rely on the measurement of the impulse response of a column, beam, or similar structure. A calibrated hammer is used to strike the structure and the resulting response is measured by a well-calibrated accelerometer or other transducer. A spectrum analyzer is used to remove the variations in the input signal and the impulse response is displayed in either spectral or time-domain form. If sufficient ingenuity is used to place the source and receiver, the results can be very diagnostic.

*c. Procedure.* A testing method is most useful when distinguishing between “good” units and “bad” structures. The method is calibrated on the known good structures and then the rest can be tested for major differences from the good ones. Obviously, the amount of change necessary to condemn a column and the range of acceptability should be decided by an experienced specialist in this field. As all structures are different and have significantly different responses, considerable engineering judgement is necessary to successfully apply nondestructive testing.



## Appendix A References - Related Publications

### American Society for Testing and Materials

#### American Society for Testing and Materials.

“Standard Test Methods for Crosshole Seismic Testing,” ASTM D-4428 M-84.

#### American Society for Testing and Materials 1988

American Society for Testing and Materials. 1988. “Geotechnical Applications of Remote Sensing and Remote Data Transmission,” STP 967, A. I. Johnson and C. B. Pettersson, ed., Philadelphia, PA.

#### Allen, Richart, and Woods 1980

Allen, N. F., Richart, F. E., Jr., and Woods, R. D. 1980. “Fluid Wave Propagation in Saturated and Nearly Saturated Sand,” *Journal of the Geotechnical Engineering Division, ASCE*, Vol 106, No. GT3, pp 235-254.

#### Annan 1992

Annan, A. P. 1992. “Ground Penetrating Radar, Workshop Notes,” Sensors and Software, Inc., Ontario, Canada.

#### Arzi 1975

Arzi, A. A. 1975. “Microgravimetry for Engineering Applications,” *Geophysical Prospecting*, Vol 23, No. 3, pp 408-425.

#### Avery and Berlin 1985

Avery, T. E., and Berlin, G. L. 1985. *Interpretation of Aerial Photographs*, Burgess Publishing Co., Minneapolis, MN.

#### Ballard, McGee, and Whalin 1992

Ballard, Robert F., McGee, Richard G., and Whalin, Robert W. 1992. “A High-Resolution Subbottom Imaging System,” *Proceedings, US/Japan Marine Facilities Panel of UNJR*, 25 October - 11 November 1992, Washington, DC.

#### Ballard et al. 1993

Ballard, R. F., Sjostrom, K. J., McGee, R. G., and Leist, R. L. 1993. “A Rapid Geophysical Technique for Sub-bottom Imaging,” Dredging Research Technical Notes DRP-2-07, U.S. Army Engineer Waterways Experiment Station, Vicksburg, MS.

#### Barker 1990

Barker, R. D. 1990. “Investigation of Groundwater Salinity by Geophysical Methods,” *Geotechnical and*

*Environmental Geophysics*, Vol 2, pp 201-212, Society of Exploration Geophysicists, Tulsa, OK.

#### Bateman 1985

Bateman, R. M. 1985. *Log Quality Control*, Boston International Human Resources Development Corp.

#### Belknap et al. 1959

Belknap, W. B., Dewan, J. F., Kirkpatrick, C. V., Mott, W. E., Pearson, A. J., and Robson, W. R. 1959. “API Calibration Facility for Nuclear Logs,” *Drilling and Production Practice*, American Petroleum Institute, pp 289-316.

#### Benson, Glaccum, and Noel 1983

Benson, R. C., Glaccum, R. A., and Noel, M. R. 1983. *Geophysical Techniques for Sensing Buried Wastes and Waste Migrations*, U.S. Environmental Protection Agency, Washington, DC, Contract No. 68-03-3050, National Water Well Association, Worthington, OH.

#### Blake 1975

Blake L. S. (Editor). 1975. *Civil Engineer's Reference Book, 3rd Edition*, Butterworths, London.

#### Blizkovsky 1979

Blizkovsky, M. 1979. “Processing and Applications in Microgravity Surveys,” *Geophysical Prospecting*, Vol 27, No. 4, pp 848-861.

#### Bodmer, Ward, and Morrison 1968

Bodmer, Rene, Ward, S. H., and Morrison, H. F. 1968. “On Induced Electrical Polarization and Ground Water,” *Geophysics*, Vol 33, No. 5, pp 805-821.

#### Bradshaw 1976

Bradshaw, J. M. 1976. “New Casing Log Defines Internal/External Corrosion,” *World Oil*, Vol 183, No. 4, pp 53-55.

#### Broding 1984

Broding, R. A. 1984. “Application of the Sonic Volumetric Scan Log to Cement Evaluation,” Society of Professional Well Log Analysts Annual Logging Symposium, 25th, New Orleans, 1984, Transactions: Houston, Society of Professional Well Log Analysts, Vol 2, pp JJ1-JJ17.

#### Butler 1983

Butler, Dwain K. 1983. “Cavity Detection and Delineation Research; Report 1, Microgravimetric Surveys, Medford Caul Site, Florida,” Technical Report GL-83-1, U.S. Army Engineer Waterways Experiment Station, Vicksburg, MS.

**Butler 1984**

Butler, Dwain K. 1984. "Microgravimetric and Gravity-Gradient Techniques for Detection of Subsurface Cavities," *Geophysics*, Vol 49, No. 7, pp 1084-1096.

**Butler 1986a**

Butler, Dwain K. 1986. "Assessment and Field Examples of Continuous Wave Electromagnetic Surveying for Ground Water; Report 10, Military Hydrology," Miscellaneous Paper EL-79-6, U.S. Army Engineer Waterways Experiment Station, Vicksburg, MS.

**Butler 1986b**

Butler, Dwain K. 1986. "Transient Electromagnetic Methods for Ground-Water Assessment," Miscellaneous Paper GL-86-27, U.S. Army Engineer Waterways Experiment Station, Vicksburg, MS.

**Butler et al. 1989**

Butler, Dwain K., Yule, Donald E., Llopis, Jose L., and Sharp, Michael K. 1989. "Geophysical Assessment of Foundation Conditions, Mill Creek Dam," Technical Report GL-89-12, U.S. Army Engineer Waterways Experiment Station, Vicksburg, MS.

**Butler, Simms, and Cook 1994**

Butler, Dwain K., Simms, Janet E., and Cook, Daryl S. 1994. "Archaeological Geophysics Investigation of the Wright Brothers 1910 Hanger Site," Technical Report GL-89-13, U.S. Army Engineer Waterways Experiment Station, Vicksburg, MS.

**Butler 1992**

Butler, Dwain K. 1992. "Proceedings of the Government Users Workshop on Ground Penetrating Radar Applications and Equipment," Miscellaneous Paper GL-92-40, U.S. Army Engineer Waterways Experiment Station, Vicksburg, MS.

**Cahyna, Mazac, and Vendhodova 1990**

Cahyna, F., Mazac, O., and Vendhodova, D. 1990. "Determination of the Extent of Cyanide Contamination by Surface Geoelectrical Methods," *Geotechnical and Environmental Geophysics*, Vol 2, pp 97-99, Society of Exploration Geophysicists, Tulsa, OK.

**Colwell 1983**

Colwell, R. N. 1983. *Manual of Remote Sensing*, Volumes 1 and 2, American Society of Photogrammetry, Falls Church, VA.

**Corwin 1989**

Corwin, Robert W. 1989. "Geotechnical Applications of the Self-Potential Method," Technical Report REMRGT-6, U.S. Army Engineer Waterways Experiment Station, Vicksburg, MS.

**Corwin and Hoover 1979**

Corwin, R. F., and Hoover, D. B. 1979. "The Self-Potential Method in Geothermal Exploration," *Geophysics*, Vol 44, No. 2, pp 226-245.

**Craig and Randall 1976**

Craig, J. T., Jr., and Randall, B. V. 1976. "Directional Survey Calculation," *Petroleum Engineer International*, March 1976, pp 38-54.

**Crowder, Paillet, and Hess 1994**

Crowder, R. E., Paillet, F. L., and Hess, A. E. 1994. "High Resolution Flowmeter Logging - A Unique Combination of Borehole Geophysics and Hydraulics; Part I, Flowmeter Techniques and Equipment Development: Borehole Applications with the Heat Pulse Flowmeter," *Proceedings of the Symposium on the Application of Geophysics to Engineering and Environmental Problems*, Vol 1.

**Das 1994**

Das, Braja M. 1994. *Principles of Geotechnical Engineering*, 3rd edition, PWS Publishing Company, Boston, MA.

**Davison, Keys, and Paillet 1982**

Davison, C. C., Keys, W. S., and Paillet, F. L. 1982. "Use of Borehole-Geophysical Logs and Hydrologic Tests to Characterize Crystalline Rock for Nuclear-Waste Storage, Whiteshell Nuclear Research Establishment, Manitoba and Chalk River Nuclear Laboratory, Ontario, Canada," Technical Report 418, Battelle Project Management Division Office of Nuclear Waste Isolation, Columbus, OH.

**Dobrin 1960**

Dobrin, M. B. 1960. *Introduction to Geophysical Prospecting*, 2nd edition, McGraw-Hill Book Co, Inc., New York.

**Dodds and Ivic 1990**

Dodds, A. R., and Ivic, D. 1990. "Integrated Geophysical Methods Used for Groundwater Studies in the Murray Basin, South Australia in Geotechnical and Environmental Geophysics," Society of Exploration Geophysicists.

**Dudgeon, Green, and Smedmor 1975**

Dudgeon, C. R., Green, M. J., and Smedmor, W. J. 1975. "Heat-Pulse Flowmeter for Boreholes," Technical Report 4, Water Research Centre, Medmenham, England.

**Duska 1963**

Duska, L. 1963. "A Rapid Curved Path Method for Weathering and Drift Corrections," *Blondeau Swartz*, Vol 28, No. 6, pp 925-947.

**Eastman Kodak Co. 1982**

Eastman Kodak Co. 1982. "Kodak for Aerial Photography," Kodak Publication No. M-29, Rochester, NY.

**Eastman Kodak Co. 1983**

Eastman Kodak Co. 1983. "Characteristics of Kodak Films," Kodak Publication No. M-57, Rochester, NY.

**Edwards and Stroud 1964**

Edwards, J. M., and Stroud, S. G. 1964. "A Report on Field Results of the Electromagnetic Casing Inspection Log." Paper SPE 664, Society of Petroleum Engineers of the American Institute of Mining, Metallurgical, and Petroleum Engineers.

**Elifrits et al. 1979**

Elifrits, C. D., Barney, T. W., Barr, D. J., and Johannsen, C. J. 1979. "Low Cost Method of Mapping Land Cover Using Satellite Images," *Learning to Use Our Environment*, The Institute of Environmental Studies, Mt. Prospect, IL.

**Erchul and Slifer 1989**

Erchul, Ronald A., and Slifer, Dennis W. 1989 (May). "The Use of Self Potential to Detect Ground-Water Flow in Karst," Technical Report REMR-GT-6, U.S. Army Engineer Waterways Experiment Station, Vicksburg, MS.

**Ewing 1939**

Ewing, S. 1939. "The Copper-Copper Sulphate Half Cell for Measuring Potentials in the Earth," *American Gas Association Proc.*

**Fajkiewicz 1983**

Fajkiewicz, Z. 1983. "Rock-Burst Forecasting and Genetic Research in Coal-Mines by Microgravity Method," *Geophysical Prospecting*, Vol 31, No. 5, pp 748-765.

**Frische and Von Buttlar 1957**

Frische, R. H., and Von Buttlar, Haro. 1957. "A Theoretical Study of Induced Electrical Polarization," *Geophysics*, Vol 22, No. 3, pp. 688-706.

**Gal'perin 1974**

Gal'perin, E. I. 1974. "Vertical Seismic Profiling," Special Publication No. 12, Society of Exploration Geophysicists.

**Geonics 1993**

Geonics. 1993. "Buried-Metal Detection with the EM61," Geonics Limited, Ontario, Canada.

**Ghosh 1971a**

Ghosh, D. P. 1971a. "Inverse Filter Coefficient for the Computation of Apparent Resistivity Standard Curves for a Horizontally Stratified Earth," *Geophysical Prospecting*, Vol 19, No. 4, pp 769-775.

**Ghosh 1971b**

Ghosh, D. P. 1971b. "The Application of Linear Filter Theory to the Direct Interpretation of Geoelectrical Resistivity Sounding Measurements," *Geophysical Prospecting*, Vol 19, pp 192-217.

**Grant and West 1965**

Grant, F. S., and West, G. F. 1965. *Interpretation Theory in Applied Geophysics*, McGraw-Hill, New York.

**Guyod 1966**

Guyod, Hubert. 1966. "Interpretation of Electric and Gamma Ray Logs in Water Wells," *The Log Analyst*, Vol 6, No. 5, pp 29-44.

**Hallof 1980**

Hallof, Philip. 1980. "Grounded Electrical Methods in Geophysical Exploration," *Practical Geophysics for the Exploration Geologist*, pp 39-152, Northwest Mining Association, Spokane, WA.

**Hardage 1983**

Hardage, B. A. 1983. "Vertical Seismic Profiling, Part A: Principles," *Geophysical Press*, London.

**Hardage and DiSiena 1984**

Hardage, B. A., and DiSiena, J. P. 1984. "Vertical Seismic Profiling," Society of Exploration Geophysicists Continuing Education Program, Denver, CO.

**Hearst and Nelson 1985**

Hearst, J. R., and Nelson, P. H. 1985. *Well Logging for Physical Properties*, McGraw-Hill, New York.

**Heiland 1940**

Heiland, C. A. 1940. *Geophysical Exploration*, Prentice-Hall, New York.

**Hempen and Hatheway 1992**

Hempen, Gregory, and Hatheway, Allen. 1992. "Geophysical Methods for Hazardous Waste Site Characterization," Special Publication No. 3, Association of Engineering Geologists, Sudbury, MA.

**Hess 1982**

Hess, A. E. 1982. "A Heat-Pulse Flowmeter for Measuring Low Velocities in Boreholes," U.S. Geological Survey Open-File Report 82-699.

**Hilchie 1968**

Hilchie, D. W. 1968. "Caliper Logging--Theory and Practice," *The Log Analyst*, Vol 9, No. 1, pp 3-12.

**Hoar 1982**

Hoar, J. H. 1982. "Field Measurement of Seismic Wave Velocity and Attenuation for Dynamic Analyses," Ph.D. diss., University of Texas at Austin.

**Hodges and Teasdale 1991**

Hodges, R. E., and Teasdale, W. E. 1991. "Considerations Related to Drilling Methods in Planning and Performing Borehole-Geophysical Logging for Ground-water Studies," Water-Resources Investigations Report 91-4090, U.S. Geological Survey.

**Hoffman, Fenton, and Pawlowicz 1991**

Hoffman, G. L., Fenton, M. M., and Pawlowicz, J. G. 1991. "Downhole Geophysics Project 1986-1990," Final Report, Alberta Research Council Information Series No. 110.

**Hollister 1967**

Hollister, J. C. 1967. "A Curved Path Refractor Method, in Seismic Refraction Prospecting," A. W. Musgrave, editor, Society of Exploration Geophysicists, Tulsa, OK, pp 217-230.

**Hudson 1976**

Hudson, D. D. 1976. "A Cost/Benefit Study of Several Land Use Mapping Methodologies Using Remotely Sensed Data," unpublished M.S. thesis, Department of Geological Engineering, University of Missouri at Rolla.

**Hudson, Elifrits, and Barr 1976**

Hudson, D. D., Elifrits, C. D., and Barr, D. J. 1976. "Investigation of the Use of Remote Sensor Imagery for Land Resource Mapping," Office of Administration, State of Missouri, Jefferson City, MO.

**Johannsen 1975**

Johannsen, H. K. 1975. "An Interactive Computer/Graphic-Display-Terminal System for Interpretation of Resistivity Soundings," *Geophysical Prospecting*, Vol 23, pp 449-458.

**Johannsen and Sanders 1982**

Johannsen, C. J., and Sanders, J. L. 1982. *Remote Sensing and Resource Management*, Soil Conservation Society of America, Ankeny, IA.

**Jones 1961**

Jones, P. H. 1961. "Hydrology of Waste Disposal, National Reactor Testing Station, Idaho," US Geological Survey IDO 22042, Issued by US Atomic Energy Commission Technical Information Service, Oak Ridge, TN.

**Jorgensen 1989**

Jorgensen, D. G. 1989. "Using Geophysical Logs to Estimate Porosity, Water Resistivity, and Intrinsic Permeability," U.S. Geological Survey Water Supply Paper 2321.

**Joyce 1978**

Joyce, A. T. 1978. "Procedures for Gathering Ground Truth Information for a Supervised Approach to a Computer-Implemented Land Cover Classification of Landsat-Acquired Multispectral Scanner Data," NASA Reference Publication No. 1015, National Aeronautics and Space Administration, Lyndon B. Johnson Space Center, Houston, TX.

**Kaufman and Keller 1983**

Kaufman, A. A., and Keller, G. V. 1983. *Frequency and Transient Soundings*, Elsevier, New York.

**Keller and Frischknecht 1966**

Keller, G. V., and Frischknecht, F. C. 1966. *Electrical Methods in Geophysical Prospecting*, Pergamon Press, New York.

**Kendall 1965**

Kendall, H. A. 1965 (Sep). "Application of SP Curves to Corrosion Detection," *Journal of Petroleum Technology*, pp 1029-1032.

**Kennett and Ireson 1982**

Kennett, P., and Ireson, R. L. 1982. "Vertical Seismic Profiles," European Association of Exploration Geophysicists, 44th Annual Meeting, Cannes, France.

**Kerfoot 1982**

Kerfoot, W. B. 1982. "Comparison of 2-D and 3-D Ground-water Flowmeter Probes in Fully Penetrating Monitoring Wells," *Proceedings of the Second National Aquifer and Ground Water Monitoring Symposium*, National Water Well Association, pp 264-268.

**Keys 1963**

Keys, W. S. 1963. "Pressure Cementing of Water Wells on the National Reactor Testing Station, Idaho," US Atomic Energy Commission, IDO 12022.

**Keys 1979**

Keys, W. S. 1979. "Borehole Geophysics in Igneous and Metamorphic Rocks," *Transactions, Society of Professional Well Loggers 20th Annual Logging Symposium*, Tulsa, Society of Professional Well Log Analysts, pp 001-0026.

**Keys 1984**

Keys, W. S. 1984. "A Synthesis of Borehole Geophysical Data at the Underground Research Laboratory, Manitoba, Canada," Technical Report 15, Battelle Project Management Division Office of Crystalline Repository Development, Columbus, OH.

**Keys 1986**

Keys, W. S. 1986. "Analysis of Geophysical Logs of Water Wells with a Microcomputer," *Ground Water*, Vol 24, No. 6, pp 750-760.

**Keys 1990**

Keys, W. S. 1990. "Borehole Geophysics Applied to Ground-water Investigations," *Techniques of Water Resources Investigations of the U.S. Geological Survey*, Book 2, Chapter E2. (Also published in 1989 by the National Water Well Association.)

**Keys 1993**

Keys, W. S. 1993. "The Role of Borehole Geophysics in a Superfund Lawsuit," *Transactions, 5th International Symposium, Minerals and Geotechnical Logging Society*.

**Keys and Boulogne 1969**

Keys, W. S., and Boulogne, A. R. 1969. "Well Logging with Californium-252," *Transactions, Society of Professional Well Log Analysts 10th Annual Logging Symposium*, Houston, Society of Professional Well Log Analysts, pp 1-25.

**Keys and Brown 1978**

Keys, W. S., and Brown, R. F. 1978. "The Use of Temperature Logs to Trace the Movement of Injected Water," *Ground Water*, Vol 16, No. 1, pp 32-48.

**Keys et al. 1979**

Keys, W. S., Wolff, R. G., Bredehoeft, J. D., Shuter, Eugene, and Healy, J. H. 1979. "In-situ Stress Measurements Near the San Andreas Fault in Central California," *Journal of Geophysical Research*, Vol 84, No. B4, pp 1583-1591.

**Keys, Crowder, and Henrich 1993**

Keys, W. S., Crowder, R. E., and Henrich, W. J. 1993. "Selecting Logs for Environmental Applications," *Seventh Annual Outdoor Action Conference on Aquifer Restoration, Groundwater Monitoring, and Geophysical Methods*, National Groundwater Association.

**Klein and Lajoie 1980**

Klein, Jan, and Lajoie, Jules. 1980. "Electromagnetic Prospecting for Minerals," *Practical Geophysics for the Exploration Geologist*, Northwest Mining Association, Spokane, WA, pp 239-290.

**Komarov et al. 1966**

Komarov, V. A., Pishpareva, H. N., Semenov, M. B., and Khloponina, L. S. 1966. "Theoretical Fundamentals for Interpretation of Survey Data Obtained with the Induced Polarization Method," Leningrad, Isdatel'stov "Nedra."

**Krige 1939**

Krige, J. J. 1939. "Borehole Temperatures in the Transvaal and Orange Free State," *Royal Society (London) Procedures Series A*, Vol 173, pp 450-474.

**Kuzmina and Ogil'vi 1965**

Kuzmina, E. N., and Ogil'vi, A. A. 1965. "On the Possibility of Using the Induced Polarization Method to Study Ground Water," *Razvedochnaya i Promyslovaya Geofizika*, No. 9, pp 47-69.

**Ladwig 1982**

Ladwig, K. J. 1982. "Electromagnetic Induction Methods for Monitoring Acid Mine Drainage," *Ground Water Monitoring Review*, Winter Issue, pp 46-57.

**Lillisand and Keifer 1994**

Lillisand, T. M., and Keifer, R. W. 1994. *Remote Sensing and Image Interpretation*, 3rd edition, Wiley, New York.

**Llopis and Butler 1988**

Llopis, Jose L., and Butler, Dwain K. 1988. "Geophysical Investigation in Support of Beaver Dam Comprehensive Seepage Investigation," Technical Report GL-88-6, U.S. Army Engineer Waterways Experiment Station, Vicksburg, MS.

**Llopis and Sjostrom 1989**

Llopis, Jose, and Sjostrom, Keith. 1989. "Geophysical Investigation at Hazardous Waste Management Site 16, Radford Army Ammunition Plant, Radford, Virginia," Miscellaneous Paper GL-89-18, U.S. Army Engineer Waterways Experiment Station, Vicksburg, MS.

**Loelkes et al. 1983**

Loelkes, G. L., Howard, G. E., Jr., Schwertz, E. L., Lampart, P. D., and Miller, S. W. 1983. "Land Use/Land Cover and Environmental Photointerpretation Keys," USGS Bulletin 1600, U.S. Geological Survey, Alexandria, VA.

**McNeill 1980**

McNeill, J. D. 1980. "Electromagnetic Terrain Conductivity Measurement at Low Induction Numbers," Technical Note TN-6, Geonics Limited, Ontario, Canada.

**McNeill 1986**

McNeill, J. D. 1986. "Rapid, Accurate Mapping of Soil Salinity Using Electromagnetic Ground Conductivity Meters," Technical Note TN-20, Geonics Limited, Ontario, Canada.

**McNeill 1990**

McNeill, J. D. 1990. "Use of Electromagnetic Methods for Groundwater Studies," *Geotechnical and Environmental Geophysics*, Vol 1, Society of Exploration Geophysicists, Tulsa, OK, pp 191-218.

**Mooney 1984**

Mooney, H. M. 1984. *Handbook of Engineering Geophysics; Volume 1: Seismic*, Bison Instruments Inc., 5706 West 36th Street, Minneapolis, MN, 55416 (612/926-1846).

**Mooney and Wetzel 1956**

Mooney, H. M., and Wetzel, W. W. 1956. "The Potentials About a Point Electrode and Apparent Resistivity

Curves for a Two-, Three-, and Four Layer Earth," University of Minnesota Press, Minneapolis, MN.

**Nettleton 1971**

Nettleton, L. L. 1971. "*Elementary Gravity and Magnetism for Geologists and Seismologists*," Society of Exploration Geophysicists, Tulsa, OK.

**Nielsen and Aller 1984**

Nielsen, David M., and Aller, Linda. 1984. "Methods for Determining the Mechanical Integrity of Class II Injection Wells," Robert S. Kerr Environmental Research Laboratory Report EPA-600/2-84-121, US Environmental Protection Agency Office of Research and Development, Ada, OK.

**Orellana and Mooney 1966**

Orellana, Ernesto, and Mooney, H. M. 1966. "Master Tables and Curves for Vertical Electrical Sounding Over Layered Structures," *Madrid Interciecia*.

**Paillet 1980**

Paillet, F. L. 1980. "Acoustic Propagation in the Vicinity of Fractures Which Intersect a Fluid-Filled Borehole," *Transactions, Society of Professional Well Log Analysts 21st Annual Logging Symposium*, pp DD1-DD33.

**Paillet 1981**

Paillet, F. L. 1981. "A Comparison of Fracture Characterization Techniques Applied to Near-Vertical Fractures in a Limestone Reservoir," *Transactions, Society of Professional Well Log Analysts 22nd Annual Logging Symposium*, pp XX1-XX29.

**Paillet and White 1982**

Paillet, F. L., and White, J. E. 1982. "Acoustic Modes of Propagation in the Borehole and Their Relationship to Rock Properties," *Geophysics*, Vol 47, No. 8, pp 1215-1228.

**Paillet, Keys, and Hess 1985**

Paillet, F. L., Keys, W. S., and Hess, A. E. 1985. "Effects of Lithology on Televiewer-Log Quality and Fracture Interpretation," *Transactions, Society of Professional Well Log Analysts 26th Annual Logging Symposium*, pp JJJ1-JJJ31.

**Paillet and Kim 1985**

Paillet, F. L., and Kim, Kunsoo. 1985. "The Character and Distribution of Borehole Breakouts and Their Relationship to In-Situ Stresses in Deep Columbia River Basalts," *Journal of Geophysical Research*.

**Paillet 1994**

Paillet, F. L. 1994. "Application of Borehole Geophysics in the Characterization of Flow in Fractured Rocks," US Geological Survey, Water Resources Investigations Report 93-4214.

**Paillet, Crowder, and Hess 1994**

Paillet, F. L., Crowder, R. E., and Hess, A. E. 1994. "High-Resolution Flowmeter Logging - A Unique Combination of Borehole Geophysics and Hydraulics; Part II, Borehole Applications with the Heat Pulse Flowmeter," *Proceedings of the Symposium on the Application of Geophysics to Engineering and Environmental Problems*, Vol 1.

**Palacky, Ritsema, and De Jong 1981**

Palacky, G. J., Ritsema, I. L., and De Jong, S. L. 1981. "Electromagnetic Prospecting for Groundwater in Precambrian Terrains in the Republic of Upper Volta," *Geophysical Prospecting*, Vol 29, pp 932-955.

**Palmer 1980**

Palmer, D. 1980. "The Generalized Reciprocal Method of Seismic Refraction Interpretation," Society of Exploration Geophysicists, Tulsa, OK.

**Parasnis 1962**

Parasnis, D. S. 1962. *Principles of Applied Geophysics*, Methuen and Co., Ltd, London.

**Parasnis 1973**

Parasnis, D. S. 1973. *Mining Geophysics*, Elsevier Scientific Publishing, New York.

**Patten and Bennett 1963**

Patten, E. P., and Bennett, G. D. 1963. "Application of Electrical and Radioactive Well Logging to Ground Water Hydrology," US Geological Survey Water Supply Paper 1544-D.

**Pedler et al. 1990**

Pedler, W. H., Barvenik, M. J., Tsang, C. F., and Hale, F. V. 1990. "Determination of Bedrock Hydraulic Conductivity and Hydrochemistry Using a Wellbore Fluid Logging Method," *Proceedings, 4th National Water Well Association Outdoor Action Conference*.

**Pedler, Head, and Williams 1992**

Pedler, W. H., Head, C. L., and Williams, L. L. 1992. "Hydrophysical Logging: A New Wellbore Technology for Hydrogeologic and Contaminant Characterization of Aquifers," *Proceedings of National Groundwater Association 6th National Outdoor Action Conference*, pp 1701-1715.

**Pirson 1963**

Pirson, S. J. 1963. *Handbook of Well Log Analysis*, Prentice-Hall, Englewood Cliffs, NJ.

**Prakash 1981**

Prakash, Shamsheer. 1981. *Soil Dynamics*, McGraw-Hill Book Company, New York.

**Redpath 1973**

Redpath, B. B. 1973. "Seismic Refraction Exploration for Engineering Site Investigations," Technical Report E-73-4, U.S. Army Engineer Waterways Experiment Station, Vicksburg, MS.

**Redpath et al. 1982**

Redpath, B. B., Edwards, R. B., Hale, R. J., and Kintzer, F. C. 1982. "Development of Field Techniques to Measure Damping Values for Near-surface Rocks and Soils," Unpublished report prepared for the National Science Foundation Earthquake Hazards Mitigation, New York.

**Schimschal 1986**

Schimschal, Ulrich. 1986. "VSP Interpretation and Applications," Schlumberger Educational Services, Houston, TX.

**Scott 1977**

Scott, J. H. 1977. "Borehole Compensation Algorithms for a Small-Diameter, Dual-Detector Density Well-Logging Probe," *Transactions, Society of Professional Well Log Analysts 18th Annual Logging Symposium*, Society of Professional Well Log Analysts, pp S1-S17.

**Seigel 1959**

Seigel, H. O. 1959. "Mathematical Formulation and Type Curves for Induced Polarization," *Geophysics*, Vol 24, No. 3, pp 547-565.

**Seigel 1970**

Seigel, H. O. 1970. "The Induced Polarization Method in Mining and Groundwater Geophysics," Geological Survey Canada, Economic Geology Report 26.

**Sharp, Yule, and Butler 1990**

Sharp, Michael K., Yule, Donald E., and Butler, Dwain K. 1990. "Geophysical Investigation of Burial Site 3-A, Defense Depot, Ogden, Utah," Miscellaneous Paper GL-90-6, U.S. Army Engineer Waterways Experiment Station, Vicksburg, MS.

**Sirles and Viksne 1990**

Sirles, P. C., and Viksne, A. 1990. "Site-Specific Shear Wave Velocity Determinations for Geotechnical Engineering Applications," *Geotechnical and Environmental Geophysics, Investigations in Geophysics No. 5*, Society of Exploration Geophysicists, Tulsa, OK, pp 121-131.

**Sirles, Custer, and McKisson 1993**

Sirles, P. C., Custer, D., and McKisson, D. 1993. "CROSSIT Version 2," (computer program for data reduction and presentation of crosshole seismic measurements), US Bureau of Reclamation, Denver, CO.

**Society of Professional Well Log Analysts 1979**

Society of Professional Well Log Analysts, Houston Chapter. 1979. "The Art of Ancient Log Analysis," Houston, TX.

**Sternberg et al. 1990**

Sternberg, Ben K., and others. 1990. "Geophysical Investigations in Support of the Arizona SSc Project," *Geotechnical and Environmental Geophysics, Vol 3*, Society of Exploration Geophysicists, Tulsa, OK, pp 211-228.

**Stokoe 1980**

Stokoe, K. H. 1980. "Field Measurement of Dynamic Soil Properties," *Specialty Conference on Civil Engineering and Nuclear Power, ASCE*, Sept. 15-17, Knoxville, TN.

**Telford et al. 1976**

Telford, W. M., and others. 1976. *Applied Geophysics*, Cambridge University Press.

**Telford, Geldart, and Sheriff 1990**

Telford, W. M., Geldart, L. P., and Sheriff, R. E. 1990. *Applied Geophysics*, Cambridge University Press, New York.

**Toksoz 1984**

Toksoz, M. N. 1984. "Vertical Seismic Profiling; Part B: Advanced Concepts," *Geophysical Press*, London.

**Tsang, Hufschmied, and Hale 1990**

Tsang, C. H., Hufschmied, P., and Hale, F. V. 1990. "Determination of Fracture Inflow Parameters with a Borehole Fluid Conductivity Method," *Water Resources Research*, Vol 26, No. 4, pp 561-578.

**U.S. Bureau of Reclamation 1989**

U.S. Bureau of Reclamation. 1989. "Seismic Design and Analysis," *Design Standards for Embankment Dams*, US Bureau of Reclamation, Denver, CO.

**U.S. Bureau of Reclamation 1992**

U.S. Bureau of Reclamation. 1992. "Geophysical Investigations at Tabor Dam," Unpublished report D-3611, Seismotectonics and Geophysics Section, US Bureau of Reclamation, Denver, CO.

**Vacquier et al. 1957**

Vacquier, Victor, Holmes, C. R., Kintzinger, P. R., and Lavergne, Michel. 1957. "Prospecting for Ground Water by Induced Electrical Polarization," *Geophysics*, Vol 12, No. 3, pp 660-687.

**van Blaricom 1980**

van Blaricom, R. 1980. "Practical Geophysics for the Exploration Geologist," Northwest Mining Association, Spokane, WA.

**Van Nostrand and Cook 1966**

Van Nostrand, R. G., and Cook, K. L. 1966. "Interpretation of Resistivity Data," US Geological Survey Prof. Paper 499.

**Vernon et al. 1993**

Vernon, J. H., Paillet, F. L., Pedler, W. H., and Griswold, W. J. 1993. "Application of Borehole Geophysics in Defining the Wellhead Protection Area for a Fractured Crystalline Bedrock Aquifer," *The Log Analyst*, Vol 35, No. 1, pp 41-57.

**Wetzel and McMurray 1937**

Wetzel, W. W., and McMurray, H. V. 1937. "A Set of Curves to Assist in the Interpretation of the Three Layer Resistivity Problem," *Geophysics*, Vol 2, pp 329-341.

**White 1983**

White, J. E. 1983. *Underground Sound, Application of Seismic Waves*, Elsevier Science Publishing Co., New York.

**Wilt and Butler 1990**

Wilt, Michael J., and Butler, Dwain K. 1990. "Geotechnical Applications of the Self Potential (SP) Method; Report 4, Numerical Modeling of SP Anomalies: Documentation of Program SPPC and Applications," Technical



Report REMR-GT-6, U.S. Army Engineer Waterways Experiment Station, Vicksburg, MS.

**Wolff et al. 1974**

Wolff, R. G., Bredehoeft, J. D., Keys, W. S., and Shuter, Eugene. 1974. "Tectonic Stress Determinations, Northern Piceance Creek Basin, Colorado," *Denver, Rocky Mountain Association of Geologists Guidebook*, pp 193-198.

**Wood 1987**

Wood, R. C. 1987. "Uses of the EM31 Terrain Conductivity Meter for Mapping Surficial Geology and Groundwater Features in Dryland Salinity Investigations--a Discussion Paper," Internal Repl, Prairie Farm Rehabilitation Administration, Lethbridge, Alberta, Canada.

**Wright 1988**

Wright, James. 1988. *VLF Interpretation Manual*, EDA Instruments Inc., 9200 E. Mineral Avenue, Suite 370, Englewood, CO 80112.

**Wyllie 1963**

Wyllie, M. R. J. 1963. *The Fundamentals of Well Log Interpretation*, Academic Press, New York.

**Yearsley and Crowder 1990**

Yearsley, E. N., and Crowder, R. E. 1990. "Acoustic Spectrum Analysis of Borehole Sonic Logs for Engineering Properties and Fracture Characterization: A Case History," *Proceedings of the 1990 Annual Symposium on Engineering Geology and Geotechnical Engineering*, No. 26.

**Yearsley, Crowder, and Irons 1991**

Yearsley, E. N., Crowder, R. E., and Irons, L. A. 1991 (Winter). "Monitoring Well Completion Evaluation with Borehole Geophysical Density Logging," *Ground Water Monitoring Review*.

**Zemanek et al. 1969**

Zemanek, J., Caldwell, R. L., Glenn, E. E., Jr., Holcomb, S. V., Norton, L. J., and Straus, A. J. D. 1969. "The Borehole Televiwer - A New Logging Concept for Fracture Location and Other Types of Borehole Inspection," *Journal of Petroleum Technology*, Vol 21, No. 6, pp 762-774.

**Zhang and Luo 1990**

Zhang, Guiqing, and Luo, Yanzhong. 1990. "The Application of IP and Resistivity Methods to Detect Underground Metal Pipes and Cables," *Geotechnical and Environmental Geophysics*, Vol 3, Society of Exploration Geophysicists, Tulsa, OK, pp 239-248.

**Zohdy 1965**

Zohdy, Adel. 1965. "The Auxiliary Point Method of Electrical Sounding Interpretation, and Its Relationship to the Dar Zarrouk Parameters," *Geophysics*, Vol 30, pp 644-660.

**Zohdy 1968**

Zohdy, Adel. 1968. "The Effect of Current Leakage and Electrode Spacing Errors on Resistivity Measurements," U.S. Geological Survey, Prof. Paper 600-D, pp 822-833.

**Zohdy 1973**

Zohdy, Adel. 1973. "A Computer Program for the Automatic Interpretation of Schlumberger Sounding Curves Over Horizontally Stratified Media," U.S. Geological Survey Open File Report No. USGS-GD-74-017.

**Zohdy 1974a**

Zohdy, Adel. 1974. "A Computer Program for the Calculation of Schlumberger Sounding Curves by Convolution," U.S. Geological Survey Open File Report No. USGS-GD-74-010.

**Zohdy 1974b**

Zohdy, Adel. 1974. *Electrical Methods in US Geological Survey, Tech Water Resources Inv*, Book 2, Chap D1.

**Zohdy 1975**

Zohdy, Adel. 1975. "Automatic Interpretation of Schlumberger Sounding Curves, Using Modified Dar Zarrouk Functions," U.S. Geological Survey Bulletin 1313-E.

**Zohdy and Bisdorf 1975**

Zohdy, Adel, and Bisdorf, R. J. 1975. "Computer Programs for the Forward Calculation and Automatic Inversion of Wenner Sounding Curves," U.S. Geological Survey.

## Appendix B Glossary

Most geophysical terms used in the manual have been defined where the terms were introduced. Additional terminology routinely used in seismic processing and well logging is presented in this glossary.

### B-1. Seismic Processing Terms

The following guide to terminology is given to assist the nonspecialist in communicating with the processing geophysicist. Processing generally consists of a series of steps with frequent iterations of earlier steps. The experience of the processor is crucial to guiding the number and timing of these iterations. The list of terms given below is not necessarily in the order used in processing, and alternative jargon with similar meanings is given.

#### Automatic Gain Control (AGC)

A process for increasing the amplitude of a trace with time, thus making all events on the trace appear to be of approximately the same amplitude. Note that this process will expand the amplitudes *even if no data are present*. Various window lengths are used; the appearance of the data may be greatly affected by the window used in the calculation.

#### Brute stack

A common midpoint stack with only preliminary static corrections (often none) and preliminary normal-moveout corrections (often constant velocity). This stack is often done by field computers to verify the existence of actual reflections.

#### Deconvolution

A data processing technique applied to seismic reflection data for the purpose of improving the recognizability and resolution of reflected events. The process reverses the effect of linear filtering processes (convolution) that have been applied to the data by recording instruments or other processes.

#### Depth section

A cross section to which a velocity function has been applied, thus converting arrival times of reflections to depths.

#### F-K filtering

As frequency filtering removes components of a signal with particular time variations (low-frequency cut, etc.), F-K filtering removes components of seismic records with

particular variations in both time (frequency) and space (K or wave number). As an example, ground roll will often be of low frequency and, due to the low velocity, have short wavelengths (high wave number). Thus, a low-frequency, high-wave number cut filter will attenuate ground roll.

#### Migration

A rearrangement of interpreted seismic data so that reflections are restored to their true location on a two-dimensional cross section. Apparent dips are restored to true dips to the extent possible.

#### Muting

Change in the amplitude of all or part of a trace before additional processing. Noisy or clearly erroneous traces are given zero amplitude. Data before the first break and the known refraction arrivals are also often reduced to zero amplitude.

#### Normal moveout corrections

Time shift corrections to reflection arrivals because of variation in shotpoint-to-geophone distance (offset). The amount of shift depends on 1) the length of the raypath from shot to reflection point to receiver, and 2) the velocity of the material traversed. Deeper reflections are corrected using velocities indicative of the deeper section.

#### Sort

Data in shot record form are sorted for display as common offset records, common shot records, common receiver records, or common depth point records.

#### Statics

Time shift corrections to individual traces to compensate for the effects of variations in elevation, surface layer thickness or velocity, or datum references.

#### Velocity panels

A set of stacked test sections with a progression of assumed normal-moveout velocities applied. A powerful method for determining velocities if distinct reflection events are present, as the reflections will be coherent where the velocities are correct and be degraded in appearance at higher or lower NMO velocities.

### B-2. Common Well-logging Terms

#### Acoustic log

Also called sonic log; a record of changes in the character of sound waves as they are transmitted through liquid-filled rock; a record of the transit time (t) is the most

common; amplitude and the full acoustic-wave form also are recorded.

**Acoustic televiewer log**

A record of the amplitude of high-frequency acoustic pulses reflected by the borehole wall; provides location and orientation of bedding, fractures, and cavities.

**Acoustic wave**

A sound wave transmitted through material by elastic deformation.

**Activation log**

Also called neutron-activation logs; a record of radiation from radionuclides that are produced in the vicinity of a well by irradiation with neutrons; the short half-life radioisotopes usually are identified by the energy of their gamma radiation or decay time.

**A electrode**

One of the current-emitting electrodes of a resistivity-logging system (A); the current return electrode is labelled B.

**Analog recording**

Data are represented as a continuous record of physical variables instead of discrete values, as in digital recording.

**Annulus**

The space between the drill pipe or casing and the wall of the drill hole; in rocks saturated with hydrocarbons, the annulus is the transition interval between the invaded zone and the uncontaminated zone.

**API unit**

The American Petroleum Institute (API) has established test pits for calibrating neutron and gamma logs. The API neutron unit is defined as 1/1,000 of the difference between electrical zero and the logged value opposite the Indiana limestone in the calibration pit that has an average porosity of 19 percent. The API gamma unit is defined as 1/200 of the deflection between intervals of high and low radioactivity in the calibration pit.

**Apparent resistivity**

Resistivity on a log that deviates from the true value, because of the effects of the borehole, invaded zone, or other extraneous effects (Ra); the term "apparent" also is used for other logs that might need correction to provide true values.

**Atomic number (Z)**

The number of protons in the nucleus of an atom equal to the number of electrons in a neutral atom.

**Atomic weight**

The total number of protons and neutrons in the nucleus of an atom.

**Back-up curve**

A curve on the analog record that displays log data on a new scale when deflections on the main curve exceed the width of the paper; usually displayed with a different pattern or color.

**Bottom-hole temperature**

The bottom-hole temperature (BHT) usually is measured with maximum recording thermometers attached to a logging probe.

**Borehole-compensated**

Probes designed to reduce the extraneous effects of the borehole and of probe position are called borehole-compensated.

**Borehole television or video**

A downhole television camera; see acoustic-televiewer definition.

**Bulk density**

Bulk density is the mass of material per unit volume; in logging, it is the density, in grams per cubic centimeter, of the rock with pore volume filled with fluid.

**Calibration**

Determination of the log values that correspond to environmental units, such as porosity or bulk density; calibration usually is carried out in pits or by comparison with laboratory analyses of core.

**Caliper log**

A continuous record of hole diameter, usually made with a mechanical probe having from one to six arms.

**Casing-collar locator**

An electromagnetic device (CCL) that usually is run with other logs to record the location of collars or other changes in casing or pipe.

**Cementation factor**

The cementation exponent ( $m$ ) in Archie's equation relating formation-resistivity factor and porosity; cementation factor as relates to many aspects of pore and grain geometry that affect permeability.

**Cement bond log**

An acoustic amplitude log that is used to determine the location of cement behind the casing and, under some conditions, the quality of the bonding to casing and rock.

**Centralizer**

A device designed to maintain a probe in the center of a borehole.

**Collimation**

The technique for forcing radiation, like gamma photons, into a beam.

**Compressional wave**

Compressional acoustic waves (P) are propagated in the same direction as particle displacement; they are faster than shear waves and are used for measuring acoustic velocity or transit time.

**Compton scattering**

The inelastic scattering of gamma photons by orbital electrons; Compton scattering is related to electron density and is a significant process in gamma-gamma (density) logging.

**Correlation**

Determination of the position of stratigraphically equivalent rock units in different wells, often done by matching the character of geophysical logs; also the matching of variables, such as log response and core analyses.

**Crossplot**

A term used in log analysis for a plot of one parameter versus another, usually two different types of logs. Useful for the identification of lithology.

**Curie**

The quantity of any radionuclide that produces  $3.70 \times 10^{10}$  disintegrations per second.

**Cycle skip**

In acoustic-velocity logging, cycle skips are caused by only one of a pair of receivers being triggered by an arriving wave, which causes sharp deflections on the log.

**Dead time**

In nuclear logging, dead time is the amount of time required for the system to be ready to count the next pulse; pulses occurring during dead time are not counted.

**Decay**

In nuclear physics, the process of disintegration of an unstable radioisotope by the spontaneous emission of charged particles or photons.

**Decentralize**

Forcing a logging probe against one side of the drill hole.

**Density log**

Also called gamma-gamma log; gamma photons from a radioactive source in the sonde are backscattered to a detector; the backscattering is related to the bulk density of the material around the sonde.

**Departure curves**

Graphs that show the correction that may be made to logs for some extraneous effects, such as hole diameter, bed thickness, temperature, etc.

**Depth reference or datum**

Zero reference for logs of a well; kelly bushing may be used if the rig is still on the well; ground level or top of casing is frequently used.

**Depth of invasion**

Radial distance from the wall of the hole to which mud filtrate has invaded.

**Depth of investigation**

See volume of investigation, also called radius or diameter of investigation.

**Detector**

Can be any kind of a sensor used to detect a form of energy, but usually refers to nuclear detectors, such as scintillation crystals.

**Deviation**

The departure in degrees between the drill hole or probe axis and vertical.

**Differential log**

A log that records the rate of change of some logged value as a function of depth; the differential log is sensitive to very small changes in absolute value.

**Digital log**

A log recorded as a series of discrete numerical values; (compare analog recording).

**Dipmeter**

A multielectrode, contact-resistivity probe that provides data from which the strike and dip of bedding can be determined.

**Directional survey**

A log that provides data on the azimuth and deviation of a borehole from the vertical.

**Dual laterolog**

A focused resistivity log with both shallow and deep investigation; usually gamma, SP, and microfocused logs are run simultaneously.

**Effective porosity**

Interconnected pore space that contributes to permeability.

**Electric log**

Generic term usually referring to the resistivity log that consists of long normal, short normal, lateral, and SP curves, but also used for other types of resistivity logs.

**Electromagnetic-casing inspection log**

The effects of eddy currents on a magnetic field are used to provide a record of the thickness of the casing wall.

**Electron volt**

The energy acquired by an electron passing through a potential difference of one volt (eV); used for measuring the energy of nuclear radiation and particles, usually expressed as million electron volts (MeV).

**Epithermal neutron**

A neutron source emits fast neutrons that are slowed by moderation to an energy level just above thermal equilibrium, where they are available for capture; most modern neutron probes measure epithermal neutrons, because they are less affected by chemical composition than thermal neutrons.

**Field print**

A copy of a log obtained at the time of logging that has not been edited or corrected.

**First reading**

The depth at which logging began at the bottom of the hole.

**Flowmeter**

A logging device designed to measure the rate, and usually the direction, of fluid movement in a well; most are designed to measure vertical flow.

**Fluid sampler**

An electronically controlled device that can be run on a logging cable to take water samples at selected depths in the well.

**Flushed zone**

The zone in the borehole wall behind the mudcake that is considered to have had all mobile native fluids flushed from it.

**Focused log**

A resistivity log that employs electrodes designed to focus the current into a sheet that provides greater penetration and vertical resolution than unfocused logs.

**Formation**

Used in well-logging literature in a general sense to refer to all material penetrated by a drill hole without regard to its lithology or structure; used in a stratigraphic sense, formation refers to a named body of rock strata with unifying lithologic features.

**Formation-resistivity factor**

Formation factor (F) is the ratio of the electrical resistivity of a rock 100 percent saturated with water ( $R_o$ ) to the resistivity of the water with which it is saturated ( $R_w$ ):  $F = R_o/R_w$ .

**Gamma log**

Also called gamma-ray log or natural-gamma log; log of the natural radioactivity of the rocks penetrated by a drill hole; also will detect gamma-emitting artificial radioisotopes (see spectral-gamma log).

**Gamma ray**

A photon that has neither mass nor electrical charge that is emitted by the nucleus of an atom; measured in gamma logging and output from a source used in gamma-gamma logging.

**Grain density**

Also called matrix density; the density of a unit volume of rock matrix at zero porosity, in grams per cubic centimeter.

**Ground electrode**

A surface electrode used for SP and resistivity logging.

**Guard log**

A type of focused resistivity log that derives its name from guard electrodes that are designed to focus the flow of current.

**Half-life**

The time required for a radioisotope to lose one half of its radioactivity from decay.

**Induction log**

A method for measuring resistivity or conductivity that uses an electromagnetic technique to induce a flow of current in the rocks around a borehole; can be used in nonconductive-borehole fluids.

**Interval transit time**

The time required for a compressional acoustic wave to travel a unit distance (t); transit time usually is measured by acoustic or sonic logs, in microseconds per foot, and is the reciprocal of velocity.

**Invaded zone**

The annular interval of material around a drill hole where drilling fluid has replaced all or part of the native interstitial fluids.

**Isotopes**

Atoms of the same element that have the same atomic number, but a different mass number; unstable isotopes are radioactive and decay to become stable isotopes.

**Lag**

The distance a nuclear logging probe moves during one time constant.

**Last reading**

The depth of the shallowest value recorded on a log.

**Lateral log**

A multielectrode, resistivity-logging technique that has a much greater radius of investigation than the normal techniques, but requires thick beds and produces an unsymmetrical curve.

**Laterolog**

A focused-resistivity logging technique; see also guard log.

**Long normal log**

A resistivity log with AM spacing usually 64 in.; see normal logs.

**Matrix**

The solid framework of rock or mineral grains that surrounds the pore spaces.

**M electrode**

The potential electrode nearest to the A electrode in a resistivity device.

**Mho**

A unit of electrical conductance that is the reciprocal of ohm.

**Microresistivity log**

Refers to a group of short-spaced resistivity logs that are used to make measurements of the mud cake and invaded zone.

**Mud cake**

Also called filter cake; the layer of mud particles that builds up on the wall of a rotary-drilled hole as mud filtrate is lost to the formation.

**Mud filtrate**

The liquid effluent of drilling mud that penetrates the wall of the hole.

**N electrode**

The potential electrode distant from the A electrode in a resistivity device.

**Neutron**

An elementary particle of the nucleus of an atom that has the same mass as a proton (1) but no charge; a neutron source is required to make neutron logs.

**Neutron log**

Neutrons from an isotopic source are measured at one or several detectors after they migrate through material in, and adjacent to, the borehole. Log response primarily results from hydrogen content, but it can be related to saturated porosity and moisture content.

**Noise**

A general term used for spurious or erratic log response not related to the property being logged; noise logs use an

**EM 1110-1-1802**  
**31 Aug 95**

acoustic receiver to detect sound caused by rapid fluid movement in the hole.

**Normal log**

A quantitative-resistivity log, made with four electrodes, that employs spacings between 4 and 64 in. to investigate different volumes of material around the borehole; see also long-normal log and short-normal log.

**Nuclear log**

Well logs using nuclear reactions either measuring response to radiation from sources in the probe or measuring natural radioactivity present in the rocks.

**Ohm ( $\Omega$ )**

The unit of electrical resistance through which 1 amp of current will flow when the potential difference is 1 V.

**Ohm-meter ( $\Omega\text{m}$ )**

Unit of electrical resistivity; the resistivity of 1 m<sup>3</sup> of material, which has a resistance of 1 ohm when electrical current flows between opposite faces; the standard unit of measurement for resistivity logs.

**Open hole**

Uncased intervals of a drill hole.

**Porosity**

The ratio of the void volume of a porous rock to the total volume, usually expressed as a percentage.

**Probe**

Also called sonde or tool; downhole well-logging instrument package.

**Proton**

The nucleus of a hydrogen atom; a positively charged nuclear particle with a mass of one; see neutron.

**Radioactivity**

Energy emitted as particles or rays during the decay of an unstable isotope to a stable isotope.

**Repeat section**

A short interval of log that is run a second time to establish repeatability and stability.

**Resistivity logs**

Any of a large group of logs that are designed to make quantitative measurements of the specific resistance of a material to the flow of electric current; calibrated in ohm-meters.

**Reversal**

A typical distortion of normal-resistivity logs opposite beds that are thinner than the AM spacing; the effect is an apparent decrease in resistivity in the center of a resistive unit.

**Rugosity**

The irregularity or roughness of the wall of a borehole.

**Saturation**

The percentage of the pore space occupied by a fluid, usually water in hydrologic applications.

**Scintillation detector**

An efficient detector used in nuclear-logging equipment; radiation causes flashes of light that are amplified and output in a crystal as electronic pulses by a photomultiplier tube to which it is coupled.

**Secondary porosity**

Porosity developed in a rock after its deposition as a result of fracturing or solution; usually not uniformly distributed.

**Shale base line**

A line drawn through the SP log deflections that represent shale; a similar technique can be used on gamma logs and can represent the average log response of sand.

**Shear wave**

An acoustic wave with direction of propagation at right angles to the direction of particle vibration (S wave).

**Short-normal log**

One of a group of normal-resistivity logs usually with AM spacing of 16 in. or less.

**Single-point resistance log**

A single electrode device used to make measurements of resistance that cannot be used quantitatively.

**Spacing**

The distance between sources or transmitters and detectors or receivers on a logging probe.

**Spectral-gamma log**

A log of gamma radiation as a function of its energy that permits the identification of the radioisotopes present.

**Spine and ribs plot**

A plot of long-spaced detector output versus short-spaced

detector output for a dual detector gamma-gamma probe; permits correction for some extraneous effects.

**Spinner survey**

A log made with an impeller flowmeter.

**Spontaneous-potential log**

A log of the difference in DC voltage between an electrode in a well and one at the surface; most of the voltage results from electrochemical potentials that develop between dissimilar borehole and formation fluids.

**Standoff**

Distance separating a probe from the wall of a borehole.

**Survey**

Oil-industry term used for the performance or result of a well-logging operation.

**Temperature log**

A log of the temperature of the fluids in the borehole; a differential temperature log records the rate of change in temperature with depth and is sensitive to very small changes.

**Thermal neutron**

A neutron that is in equilibrium with the surrounding medium such that it will not change energy (average 0.025 eV) until it is captured.

**Time constant**

The time in seconds required for an analog system to record 63 percent of the change that actually occurred from one signal level to another.

**Tracer log**

Also called tracejector log; a log made for the purpose of measuring fluid movement in a well by means of following a tracer injected into the well bore; tracers can be radioactive or chemical.

**Track**

Term used for the areas in the American Petroleum Institute log grid that are standard for most large well-logging companies; track 1 is to the left of the depth column, and tracks 2 and 3 are to the right of the depth column, but are not separated.

**Transducer**

Any device that converts an input signal to an output signal of a different form; it can be a transmitter or receiver in a logging probe.

**Variable-density log (VDL)**

Also called 3-dimensional log; a log of the acoustic wave train that is recorded photographically, so that variations in darkness are related to the relative amplitude of the waves.

**Z/A effect**

Ratio of the atomic number (Z) to the atomic weight (A), which affects the relation between the response of gamma-gamma logs and bulk density.